

# CIRANDA DAS

Sí-la-las



Ciranda Cultural

Volume 5

## PARLENDA

O DOCE PERGUNTOU PRO DOCE  
QUAL É O DOCE MAIS DOCE?  
E O DOCE RESPONDEU PRO DOCE  
QUE O DOCE MAIS DOCE  
É O DOCE DE BATATA-DOCE.

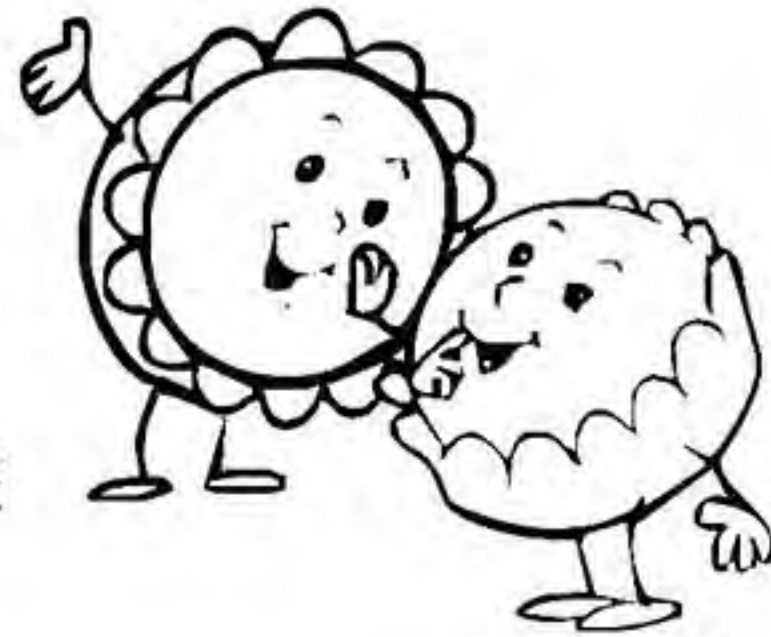

DOMÍNIO PÚBLICO

ASSINALE NO TEXTO, ACIMA, A PALAVRA **DOCE**.

DOCE

doce

CE - C

ce - c

SEPARE A PALAVRA DOCE EM LETRAS E SÍLABAS.

DOCE

VEJA O QUE PODEMOS ESCREVER COM A SÍLABA **CE**.  
CIRCULE CADA **CE** NAS PALAVRAS ABAIXO.

CÉDULA

DOCE

CELA

CEGO

FACE

CERA

CEGONHA

VOCÊ

CEBOLA

CEDO

BOCEJO

CAPACETE

CENOURA

VICE

CENA

CEIA

CEVADA

CÁLICE

CEREJA

CÓCEGAS

CESTA

LIGUE E FORME PALAVRAS  
ESCREVENDO-AS AO LADO.

<div style="border: 1px solid black; padding: 2px; display: inline-block;">CE</div>	GO	_____	<div style="border: 1px solid black; padding: 2px; display: inline-block;">CE</div>	DO	_____
	DO	_____		FA	_____
	NOURA	_____		VO	_____
	BOLA	_____		VI	_____
	GONHA	_____			

BO	<div style="border: 1px solid black; padding: 2px; display: inline-block;">CE</div>	JO
CAPA		TE
CÓ		GAS

NUMERE OS DESENHOS DE ACORDO COM AS PALAVRAS.

- 1 - DOCE
  - 2 - CENOURA
  - 3 - CEBOLA
  - 4 - CAPACETE
  - 5 - CÁLICE
  - 6 - CÉU
  - 7 - CEGONHA
  - 8 - CESTA
  - 9 - CEREJA

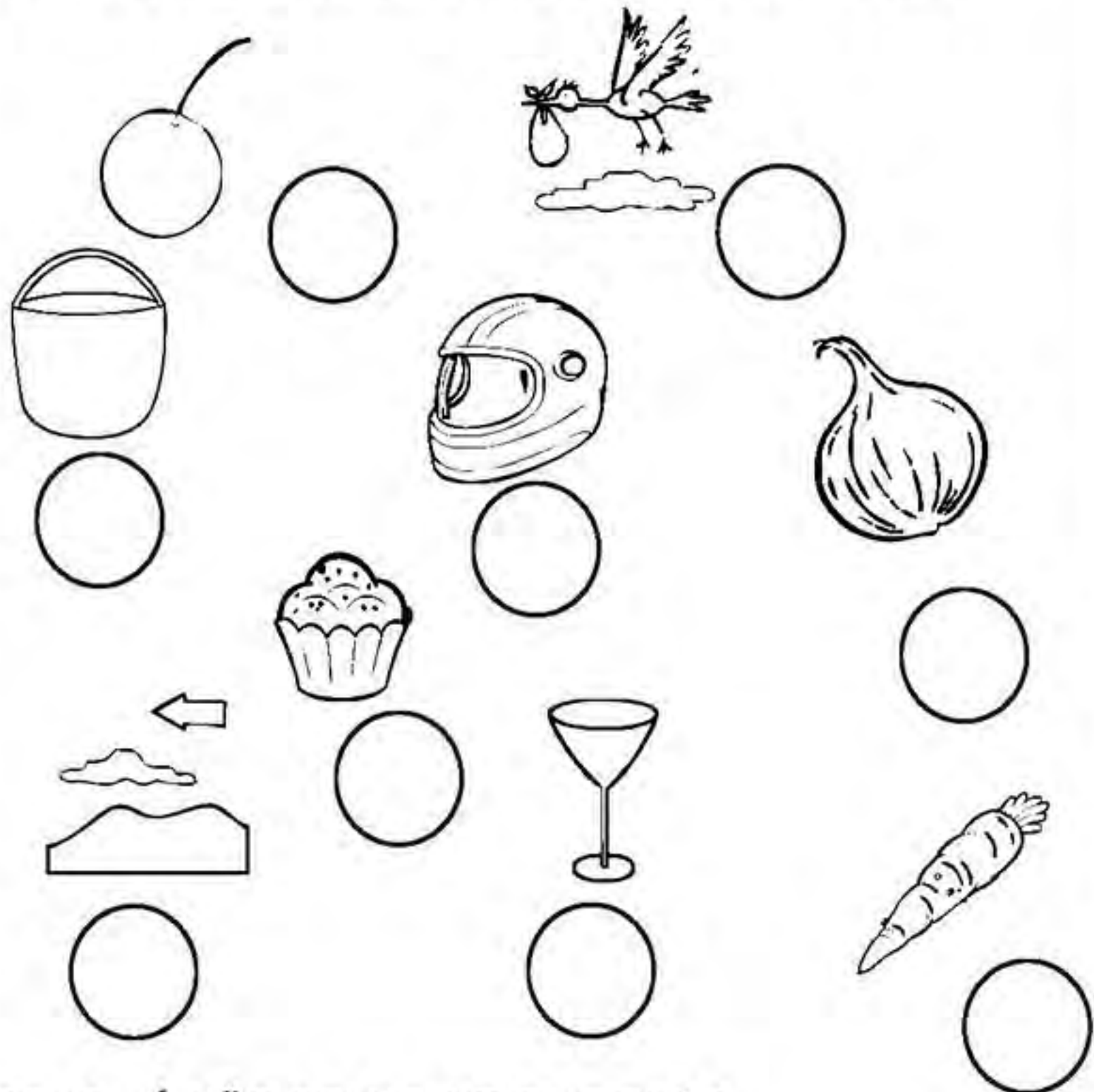

ADIVINHE:  
 MINHA VIDA É UM PESADELO, JÁ NÃO SEI NEM O QUE FAÇO.  
 POIS QUEM MAIS CHORA POR MIM, É QUEM ME CORTA EM PEDAÇOS?  
 (CEBOLA)

JUNTE AS SÍLABAS ESCRITAS NA CENTOPÉDIA, DE ACORDO COM OS NÚMEROS ABAIXO E ESCREVA AS PALAVRAS FORMADAS.



1 - 4 - 7

\_\_\_\_\_

1 - 6

\_\_\_\_\_

1 - 7

\_\_\_\_\_

6 - 1

\_\_\_\_\_

1 - 9 - 11

\_\_\_\_\_

1 - 8

\_\_\_\_\_

10 - 5 - 1 - 3

\_\_\_\_\_

1 - 12

\_\_\_\_\_

2 - 1

\_\_\_\_\_

11 - 1

\_\_\_\_\_

3 - 1

\_\_\_\_\_

10 - 1

\_\_\_\_\_

PINTE AS SÍLABAS, FORMANDO PALAVRAS. USE CORES DIFERENTES PARA CADA PALAVRA FORMADA.

CA	CE	CE	DO
BO	PA	NA	VO
CE	LA	CE	FA
LA	NOU	DO	CÊ
CE	TE	RA	CE
CE	CE	GO	CE

\_\_\_\_\_

\_\_\_\_\_

\_\_\_\_\_

\_\_\_\_\_

\_\_\_\_\_

\_\_\_\_\_

DESCUBRA O SEGREDO E ESCREVA OUTRAS PALAVRAS.

DOCE  
FACE  
VOCÊ

---

---

CÉU  
CESTA  
CEGO

---

---

CAPACETE  
CÓCEGAS  
CÁLICE

---

---

LIGUE O NOME AO DESENHO CORRESPONDENTE E ESCREVA A PALAVRA QUE VOCÊ LIGOU SEPARANDO-A EM SÍLABAS.

CEDO  
CEBOLA  
DOCE



---



CERA  
CENOURA  
CEBOLA

---

FACE  
VOCÊ  
DOCE



---



CESTA  
ACÉM  
VICE

---

CEVADA  
CÓCEGAS  
CAPACETE



---

CEGONHA  
CEGO  
CEIA



---

QUAL O NÚMERO DE SÍLABAS DAS PALAVRAS?  
ESCREVA NAS CEREJINHAS.

CENOURA



CEREJA



CÓCEGAS



CEBOLA

CEGO



CAPACETE



CEVADA



CEDO



ESCREVA AS PALAVRAS NO DOMINOX,  
PORÉM SEPARANDO-AS EM SÍLABAS.



- CAPACETE
- CEDO
- BOCEJO
- CERVEJADA
- CEBOLA
- CERA
- CENOURA
- CENA
- DOCE
- CEGO

				CE
				GO

ESCREVA AS FRASES SUBSTITUINDO OS  
DESENHOS PELAS PALAVRAS CORRESPONDENTES.

CÉLIA FEZ SALADA DE ALFACE E  .

CELITA FEZ UM  DE  COM COCO.

NA  TEM  E  .

CÉLIO COLOCOU O  PARA ANDAR DE MOTO.

O BOMBOM FOI FEITO COM  .

CAÇA – PALAVRAS.

C	E	I	A	R	C	E	L	A	Q
Z	P	L	D	C	E	R	E	J	A
C	E	N	O	U	R	A	M	P	R
A	F	A	C	E	A	L	S	T	U
P	S	C	E	B	O	L	A	A	Z
A	C	E	G	O	N	H	A	C	P
C	É	R	Z	K	X	V	Q	É	C
E	U	T	W	D	F	C	E	M	E
T	V	O	Y	I	J	A	B	K	N
E	X	X	C	Á	L	I	C	E	A

DOCE	CEGONHA	CELA	CÉU
CÁLICE	FACE	CEREJA	CERTO
CENOURA	ACÉM	CEBOLA	CEM
CAPACETE	CEIA	CERA	CENA

É HORA DO DITADO.

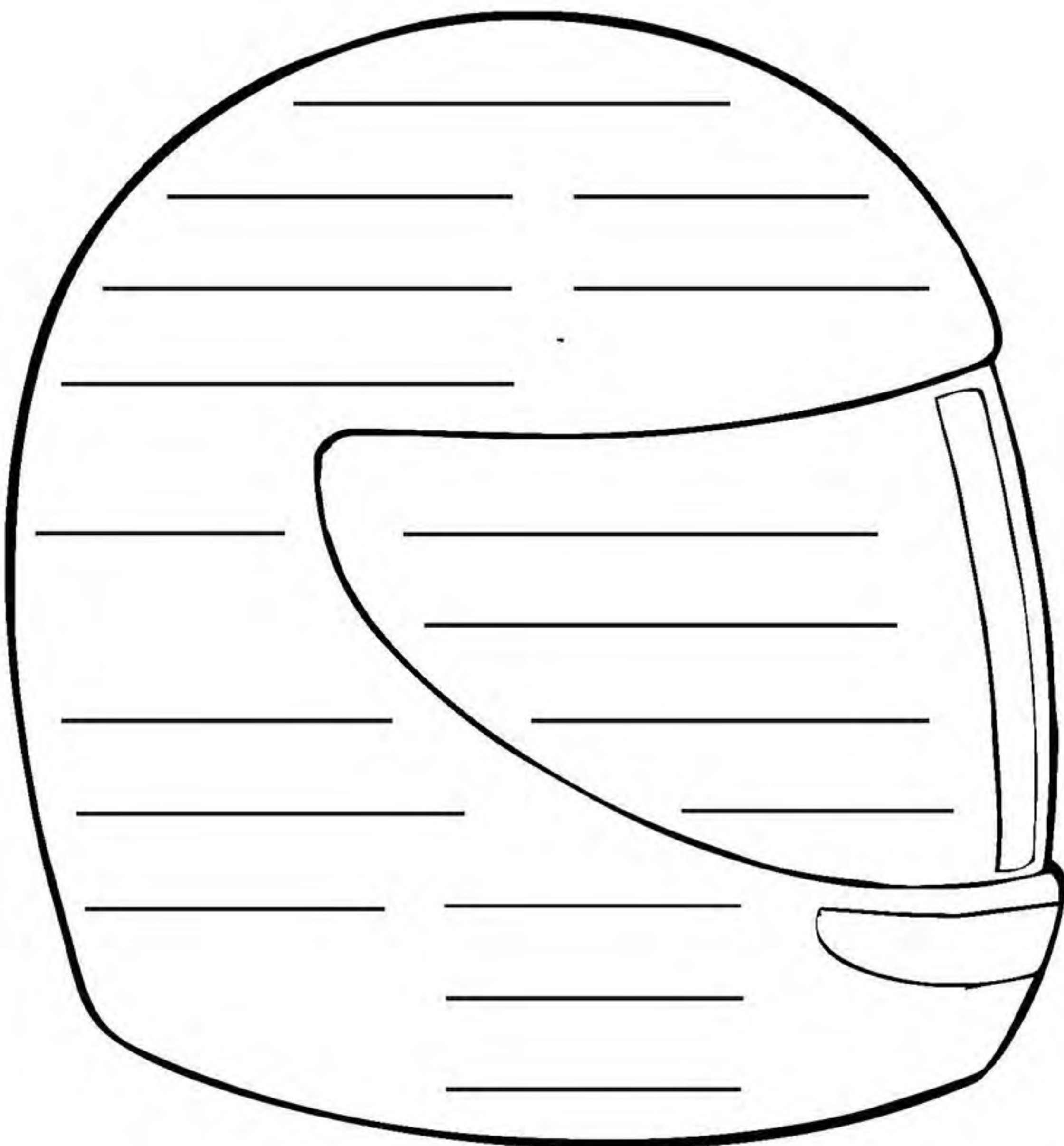



## A CASINHA DA VOVÓ

A CASINHA DA VOVÓ  
TODA FEITA DE CIPÓ.  
O CAFÉ ESTÁ DEMORANDO  
COM CERTEZA FALTA PÓ.



(CD AS MELHORES CANTIGAS, CIRANDA CULTURAL, pág. 115.)

ASSINALE NO TEXTO DA CANTIGA, A PALAVRA **CIPÓ**.

COPIE.

CIPÓ

cipó

Ci-Ci

ci-cl

SEPARE A PALAVRA **CIPÓ** EM LETRAS E SÍLABAS.

CIPÓ

CIRCULE A SÍLABA **CI** NAS PALAVRAS DO QUADRO.

CINEMA	POLÍCIA	CICA	CIRCO
CIDADE	TECIDO	CINTA	MACIO
VACINA	FELICIDADE	BACIA	CECÍLIA
BICICLETA	SACI	APARECIDA	CACIQUE
CIGANA	VELOCIDADE	CIGARRA	CÍCERO

LEIA AS PALAVRAS ABAIXO E ESCREVA-AS,  
COMPLETANDO ADEQUADAMENTE AS FRASES.

PEIXE

CINEMA

SACI

CELA

O \_\_\_\_\_ PULA NUMA PERNA SÓ.

CERA

CEDO

POLÍCIA

OFICINA

CIDO TRABALHA NA \_\_\_\_\_ DE CARROS.

CEBOLA

VACINA

CENOURA

CÓCEGAS

O BEBÊ CHOROU PORQUE TOMOU \_\_\_\_\_.

CAPACETE

CESTA

TECIDO

CIGANA

MAMÃE FEZ UMA BLUSA DE \_\_\_\_\_ XADREZ.

CEREJA

CIDADE

CEBOLA

BACIA

CECÍLIA E APARECIDO FORAM PASSEAR NA \_\_\_\_\_.

JUNTE AS SÍLABAS E ESCREVA AS PALAVRAS FORMADAS.

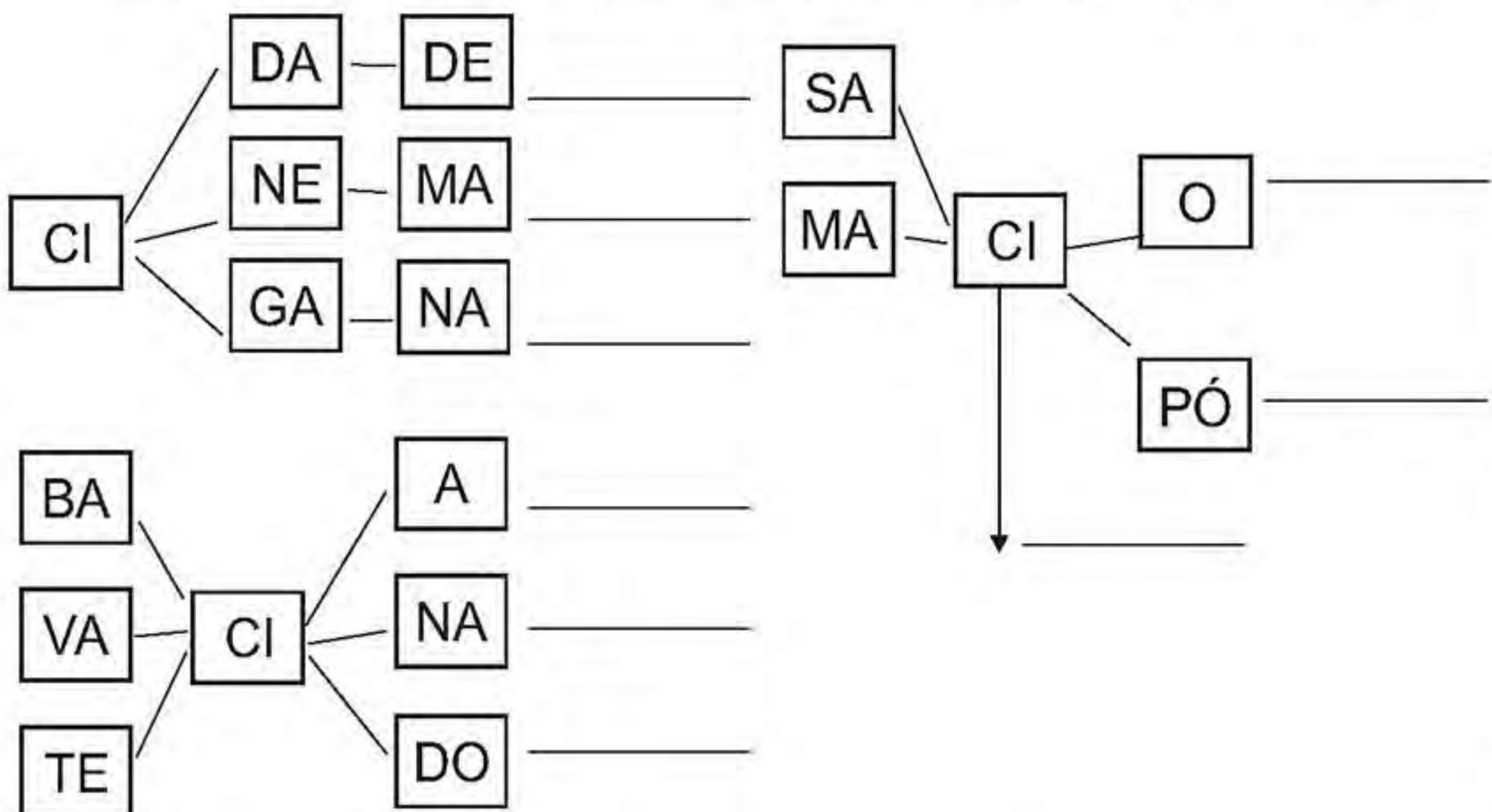

# CIRANDA, CIRANDINHA

CIRANDA, CIRANDINHA

VAMOS TODOS CIRANDAR.

VAMOS DAR A MEIA VOLTA,

VOLTA E MEIA VAMOS DAR.



DOMÍNIO PÚBLICO

CIRCULE NO TEXTO DA CANTIGA,  
AS PALAVRAS QUE TÊM A SÍLABA **CI**.

PINTE AS SÍLABAS QUE CORRESPONDEM  
AOS NOMES DOS DESENHOS.



CI PE PÓ



CI FA GAR RA



BA CA CI A



CA SA CE CI



DI CI GA MA NA















CIN SA TA SI

















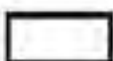





JUNTE AS SÍLABAS DO QUADRO E  
ESCREVA AS PALAVRAS FORMADAS.

+	DO	GA	NA	LA
CE	_____	_____	_____	_____
+	DA	PÓ	CA	DRA
CI	_____	_____	_____	_____

SUBSTITUA OS SÍMBOLOS PELAS  
 SÍLABAS E FORME PALAVRAS.

VA 	CE 	CI 	RA 	GO 	NA 
---	---	--	---	---	---

DA 	COI 	RE 	NHA 	NOU 	BO 
---	--	---	--	--	---

  	 	  
_____	_____	_____
 	  	 
_____	_____	_____
 	  	  
_____	_____	_____

ESCREVA ABAIXO O QUE SE PEDE.  
 OBSERVE A SÍLABA SOLICITADA.

SÍLABA	FRUTA	OBJETO	ANIMAL	NOME DE PESSOA
CE	_____	_____	_____	_____
CI	_____	_____	_____	_____

ADIVINHE:

POR FORA SOU VERDE E BEM RAJADA, POR DENTRO BRANCA E VERMELHA.  
 TODOS GOSTAM DE ME COMER EM FATIAS. EU SOU A \_\_\_\_\_.

(MELANCIA)

LEIA AS PALAVRAS E ESCREVA-AS NO QUADRO ABAIXO, DE ACORDO COM AS SÍLABAS INDICADAS.

CIDADE	CEGO	VACINA	DOCE
VOCÊ	CINEMA	CEBOLA	SACI
TECIDO	CENOURA	CIRCO	CAPACETE
CEDO	BACIA	CEIA	CIGANO

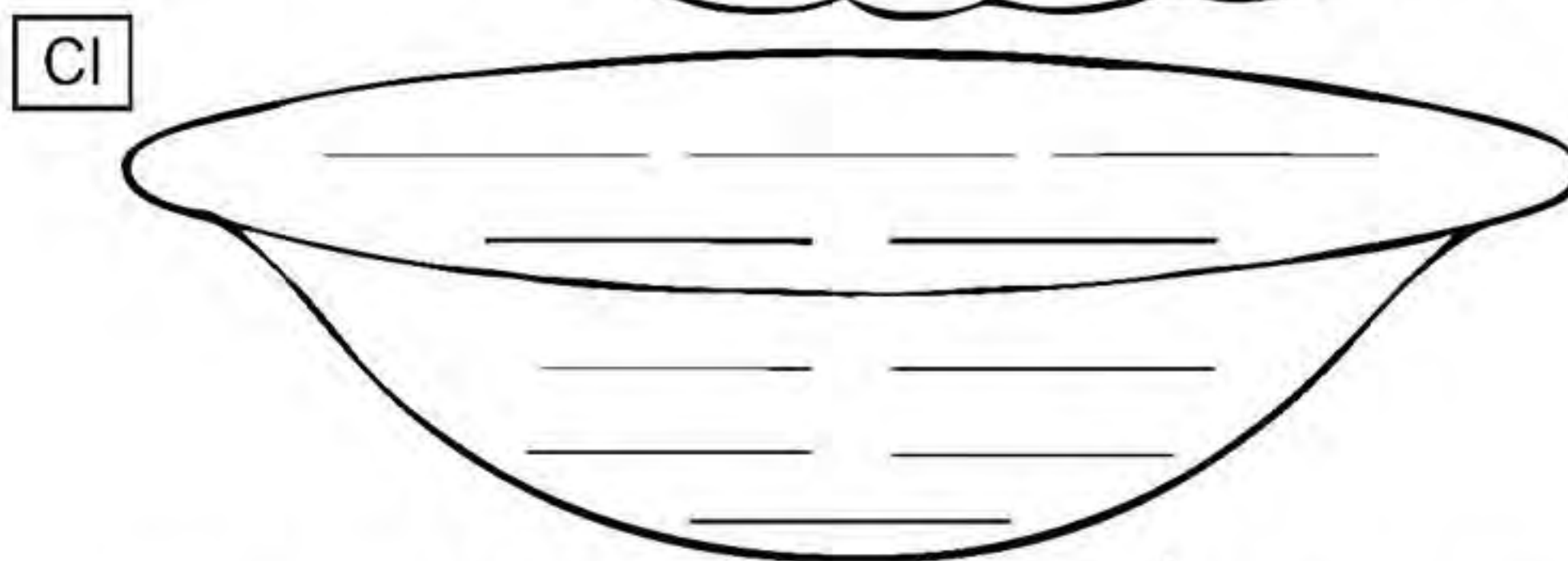
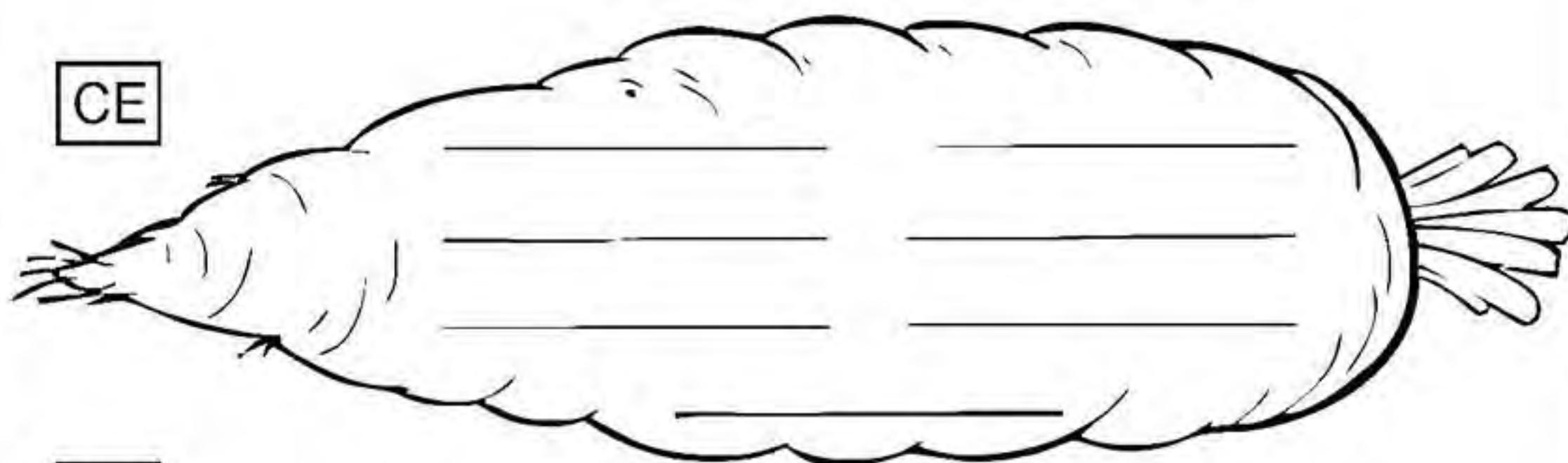

COMPLETE AS PALAVRAS COM AS SÍLABAS **CE** OU **CI**.  
DEPOIS ESCREVA, SEPARANDO-AS EM SÍLABAS.

___DADE

___DO

___GARRA

FELI___DADE

CAPA___TE

___BOLA

VA___NA

DO___

CRUZA - PALAVRAS.

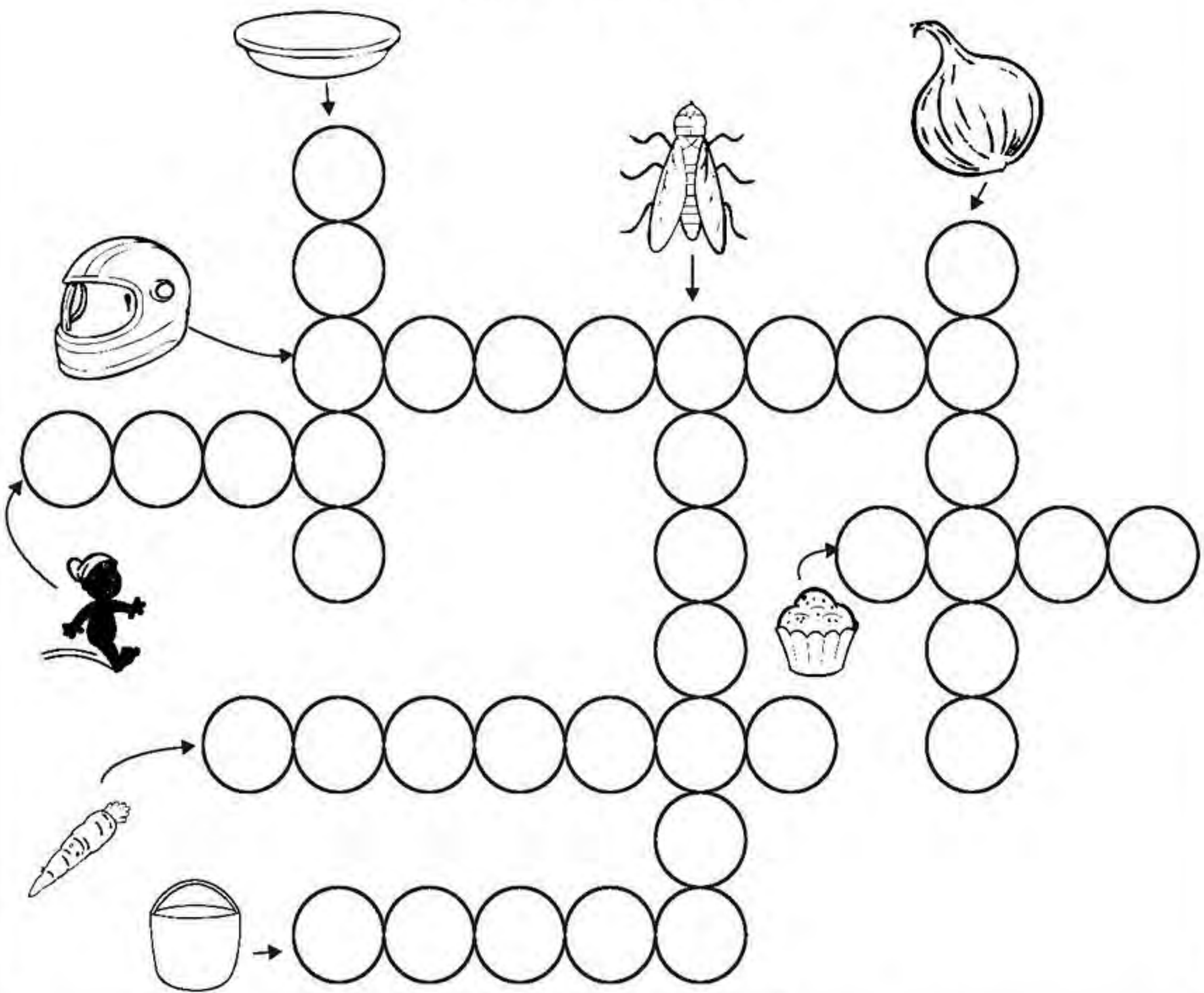

CESTA	DOCE	CEBOLA	SACI
CAPACETE	CIGARRA	BACIA	CENOURA

ESCREVA PALAVRAS COM AS SÍLABAS INDICADAS.

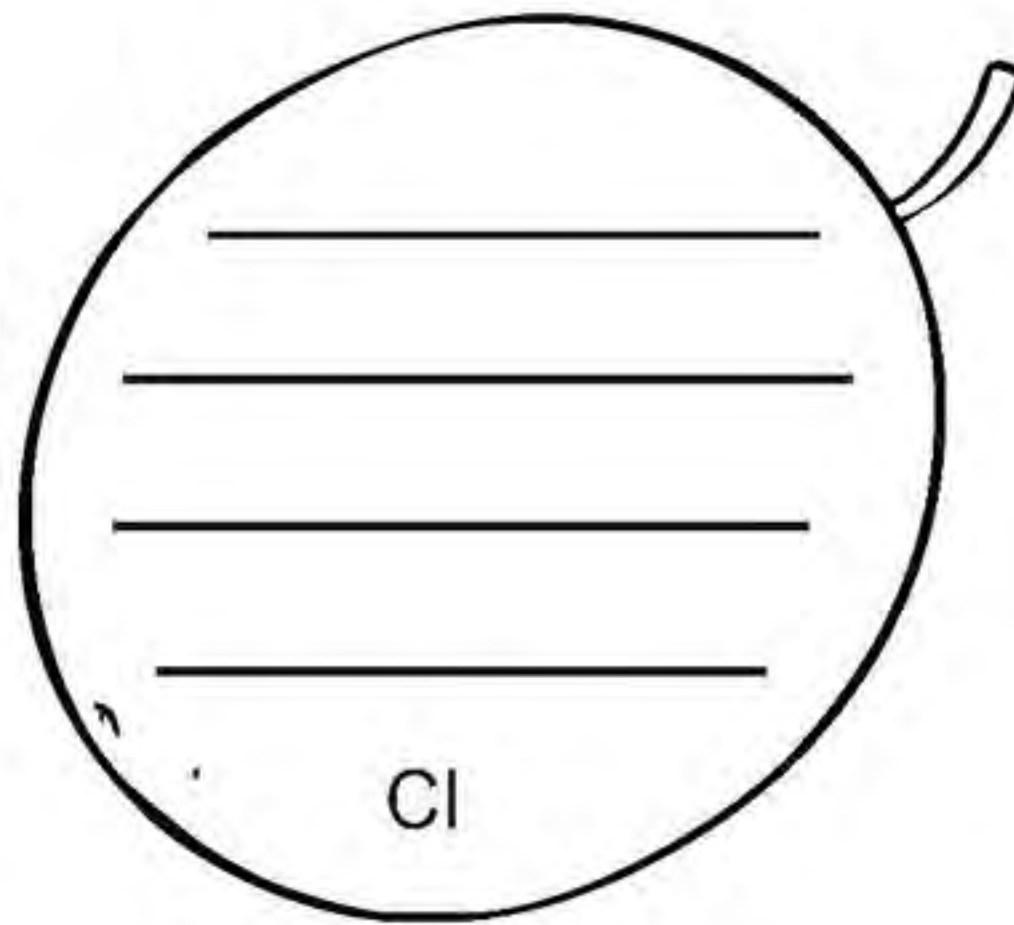
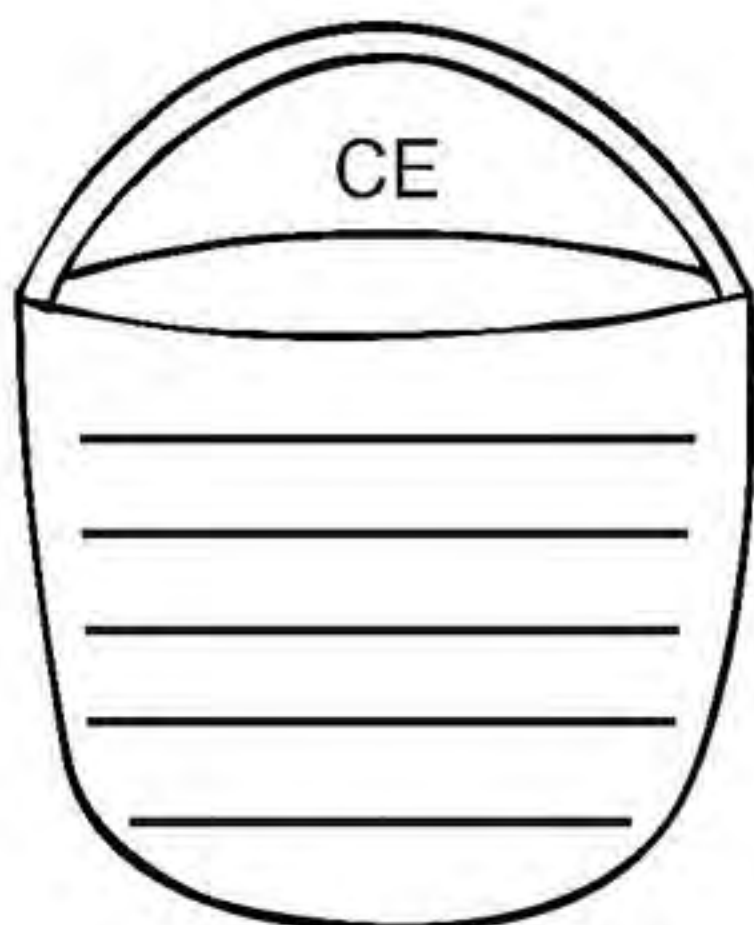



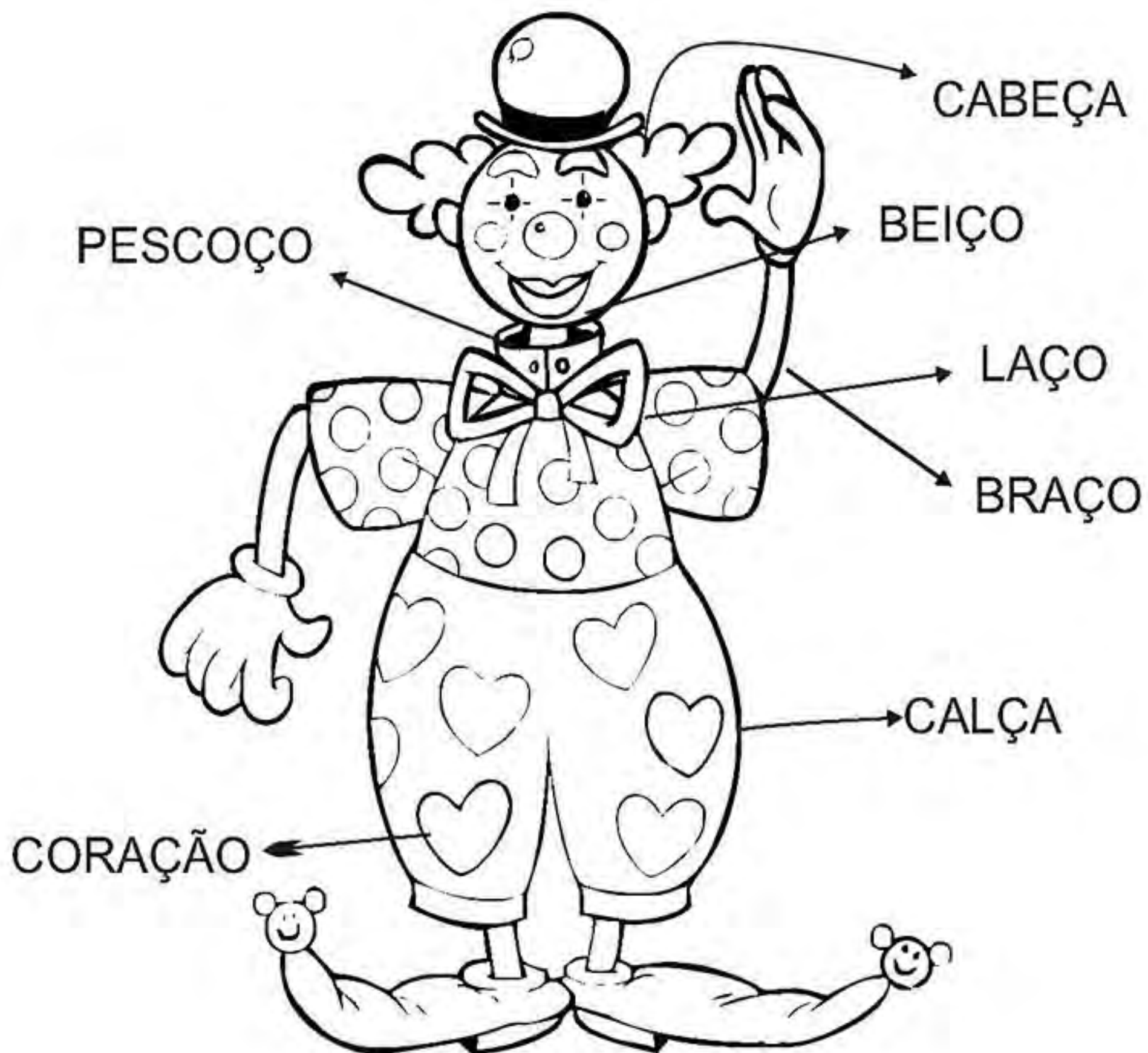











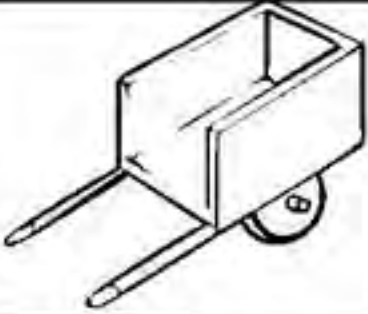





## PALHAÇO BEIÇUDO



LEIA AS PALAVRAS ESCRITAS, NO PALHAÇO BEIÇUDO. OBSERVE: TODAS TÊM A LETRA **Ç**. ANTES DAS LETRAS A, O, U; USAMOS A LETRA **Ç**.

AÇÚCAR	AÇUCENA	MOÇO	BALANÇO
AÇUDE	FUMAÇA	POÇO	TAÇA
CARROÇA	CORAÇÃO	CAÇAROLA	BEIÇO
CABEÇA	EMOÇÃO	OURIÇO	LAÇO
PALHOÇA	CAROÇO	ONÇA	BRAÇO

RECORTE AS PALAVRAS DAS FICHAS E COLE-AS,  
DE ACORDO COM OS NOMES DOS DESENHOS.

POÇO	TAÇA	DOCE	CAROÇO
BALANÇO	LAÇO	AÇÚCAR	MAÇÃ
CORAÇÃO	CAÇAROLA	ONÇA	CARROÇA
BRAÇO	FUMAÇA	CALÇA	PEDAÇO
CEREJA	PALHAÇO	CABEÇA	MELANCIA



DESCUBRA PALAVRAS COM **ÇA**, **ÇO** E **ÇU** E COPIE-AS AO LADO DO QUADRO. PARA CADA PALAVRA ENCONTRADA, PINTE COM UMA COR DIFERENTE.

PO	PA	LHA	ÇO	CA	_____	_____
MO	ÇO	BRA	ÇO	RO	_____	_____
ÇO	FU	MA	ÇA	ÇO	_____	_____
CA	ÇA	RO	LA	A	_____	_____
MA	ÇÃ	CO	RA	ÇÃO	_____	_____
CA	BE	ÇA	ÇU	CAR	_____	_____

VAMOS DESCOBRIR PALAVRAS NOVAS? ELIMINE A ÚLTIMA LETRA DA PALAVRA E JUNTE O QUE ESTÁ NA FICHA.

ROÇA  
CARROÇA  
POÇO

EIRO

O QUE ACONTECEU COM A LETRA **Ç** ?

\_\_\_\_\_  
\_\_\_\_\_  
\_\_\_\_\_

ESCREVA PALAVRAS QUE RIMEM COM:

MOÇO

\_\_\_\_\_, \_\_\_\_\_, \_\_\_\_\_

EMOÇÃO

\_\_\_\_\_, \_\_\_\_\_, \_\_\_\_\_

MOÇA

\_\_\_\_\_, \_\_\_\_\_, \_\_\_\_\_

LEIA AS PALAVRAS DO QUADRO, DEPOIS ESCREVA-AS, DE ACORDO COM O QUE SE PEDE ABAIXO.

CECÍLIA	MELANCIA	OURIÇO	CABEÇA
CORAÇÃO	CEREJA	PESCOÇO	TAÇA
APARECIDO	BRAÇO	CIÇA	ONÇA
AÇUCENA	CIGARRA	ACEROLA	CAÇAROLA
MORCEGO	AÇUCAREIRO	BEIÇO	MAÇÃ

PARTES DO NOSSO CORPO

NOME DE FRUTA

NOME DE FLORES

NOME DE PESSOAS

NOME DE ANIMAIS

NOME DE OBJETOS

LIGUE AS SÍLABAS E ESCREVA AS PALAVRAS.

LA	_____	BA	→	GA	_____
BRA	_____	CA	→	RO	_____
MO	→	PES	→	CO	→
PO	→	BA	→	LAN	_____
CAL	_____	CHU	→	MA	_____

PINTE AS PALAVRAS DO QUADRO,  
DE ACORDO COM A LEGENDA.

ÇA AZUL    ÇO VERMELHO    ÇU VERDE    ÇÃO AMARELO

CAÇULA	PEDAÇO	MOÇA	EMOÇÃO
LIÇÃO	FUMAÇA	CALÇÃO	CAROÇO
BABAÇU	POÇO	AÇUDE	CALÇA
ONÇA	AÇÚCAR	PESCOÇO	RAÇÃO
LAÇO	CORAÇÃO	TAÇA	AÇUCENA

ESCREVA OS NOMES DOS DESENHOS  
E SEPRE AS PALAVRAS EM SÍLABAS.











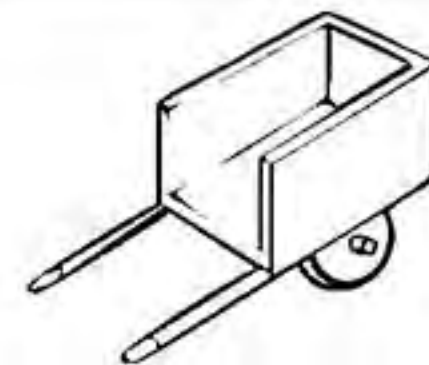









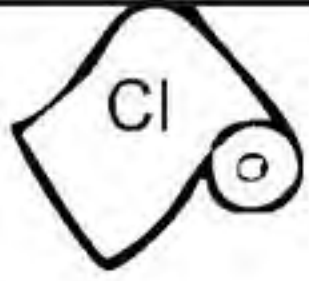

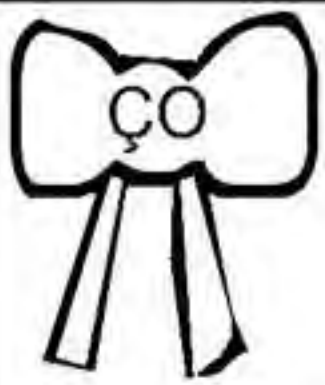
LEIA AS PALAVRAS DOS DESENHOS E  
COPIE-AS NO LUGAR INDICADO.



RECORTE E COLE AS FICHAS DAS PALAVRAS,  
DE ACORDO COM AS FAMÍLIAS SILÁBICAS.



S



CE



CI



Ç

CEDO	AÇUCENA	MACIO	CIRCO
SEMANA	CINEMA	SÍTIO	DOCE
TAÇA	SACOLA	MOÇO	SOPA
CIDADE	CEBOLA	POLÍCIA	AÇÚCAR
CAPACETE	SUCO	PAÇOCA	CEGONHA

### AUTODITADO

ESCREVA PALAVRAS, DE ACORDO COM AS SÍLABAS INDICADAS NOS QUADROS.

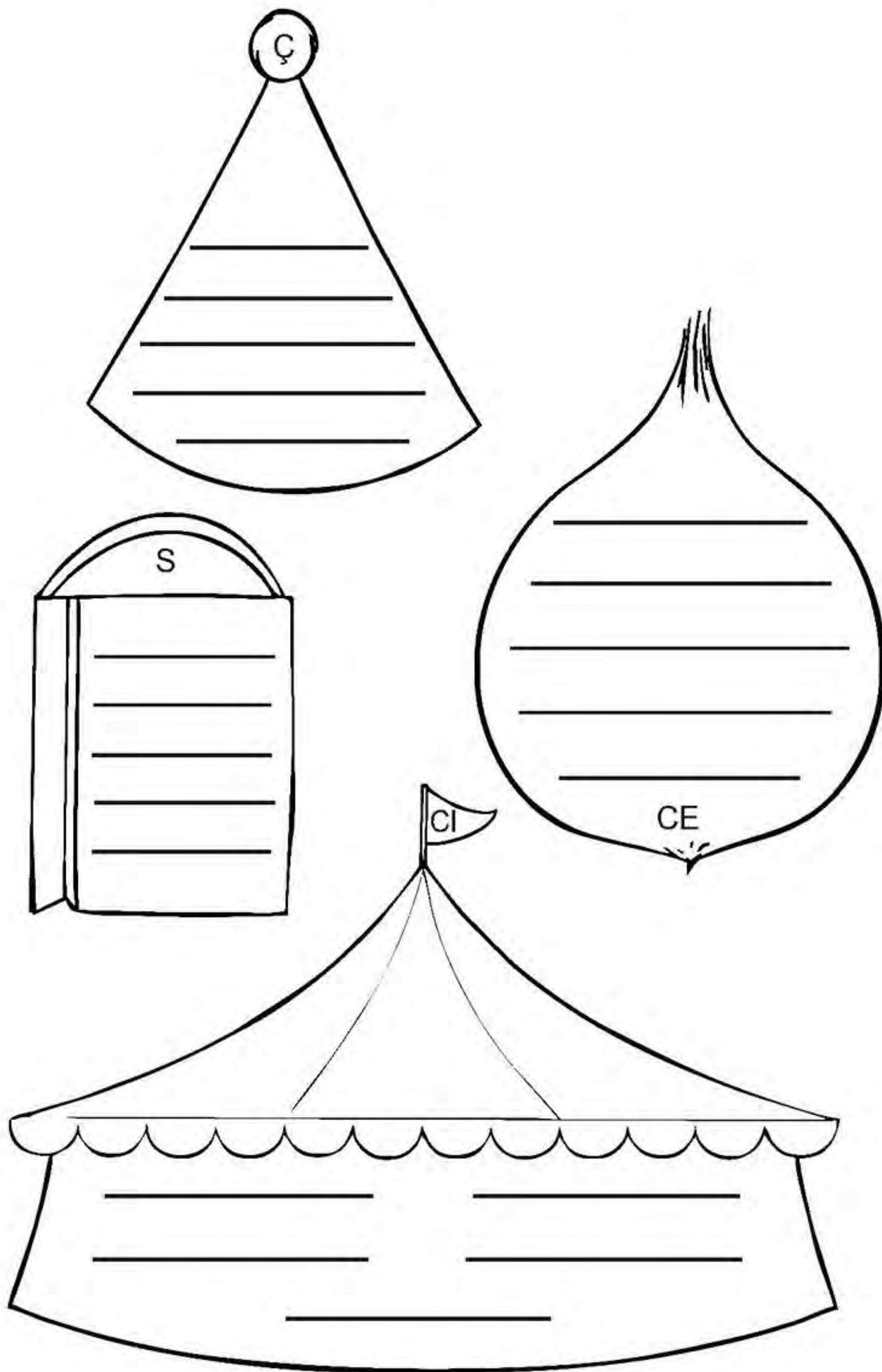

Q

Q

QUINZINHO CARREGA O QUEIJO,  
TEM DOIS QUIABOS NO CHÃO.  
HIRO TREINA DE QUIMONO.  
ELE QUER SER CAMPEÃO!

NINGUÉM SABE ONDE COMEÇA  
E ONDE TERMINA O FLOQUINHO!  
NO QUADRO, A MÔNICA LISA  
DÁ UM SORRISO DENTUCINHO!

© 2007 - ABC Turma da Mônica: Maurício de Sousa Editora - edição Brasil

CIRCULE NO TEXTO AS PALAVRAS QUE TÊM A LETRA **q - Q**.  
COPIE.

QUEIJO

queijo

queijo

QUE

Que

que

que

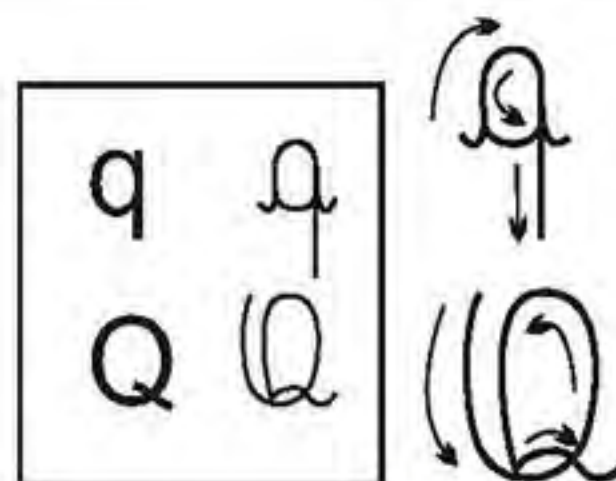
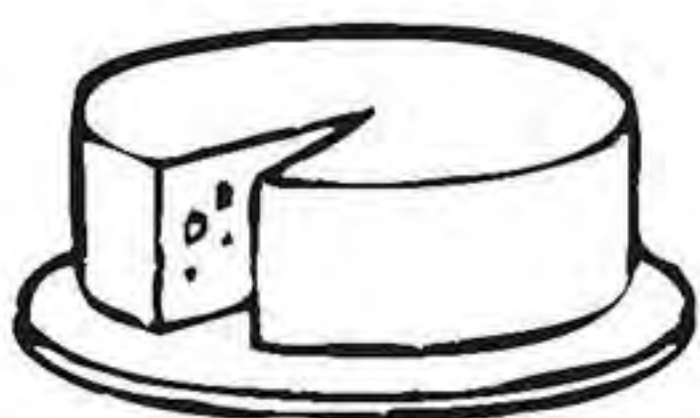

## PERIQUITO MARACANÃ

PERIQUITO MARACANÃ  
CADÊ A SUA IAIÁ,  
FAZ UM DIA, FAZ UM ANO  
QUE EU NÃO VEJO ELA PASSAR.



DOMÍNIO PÚBLICO

CIRCULE NO TEXTO A PALAVRA **PERIQUITO**.

PERIQUITO

periquito

periquito

QUI

Qui

qui

qui

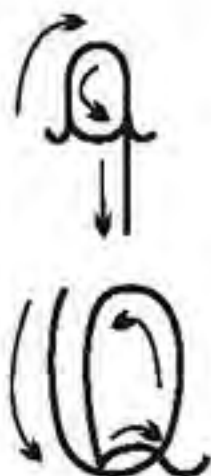
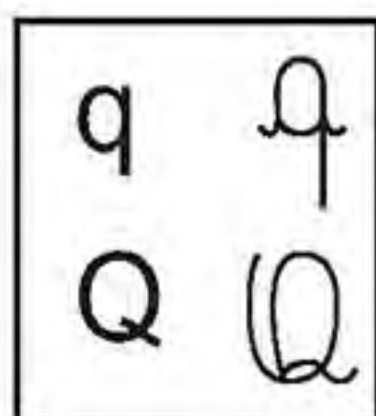

aqui quis quibe  
QUIRINO caqui esquilo  
máquina QUITÉRIA  
pequi quindim quilo  
pequi aquilo  
quiabo equipe





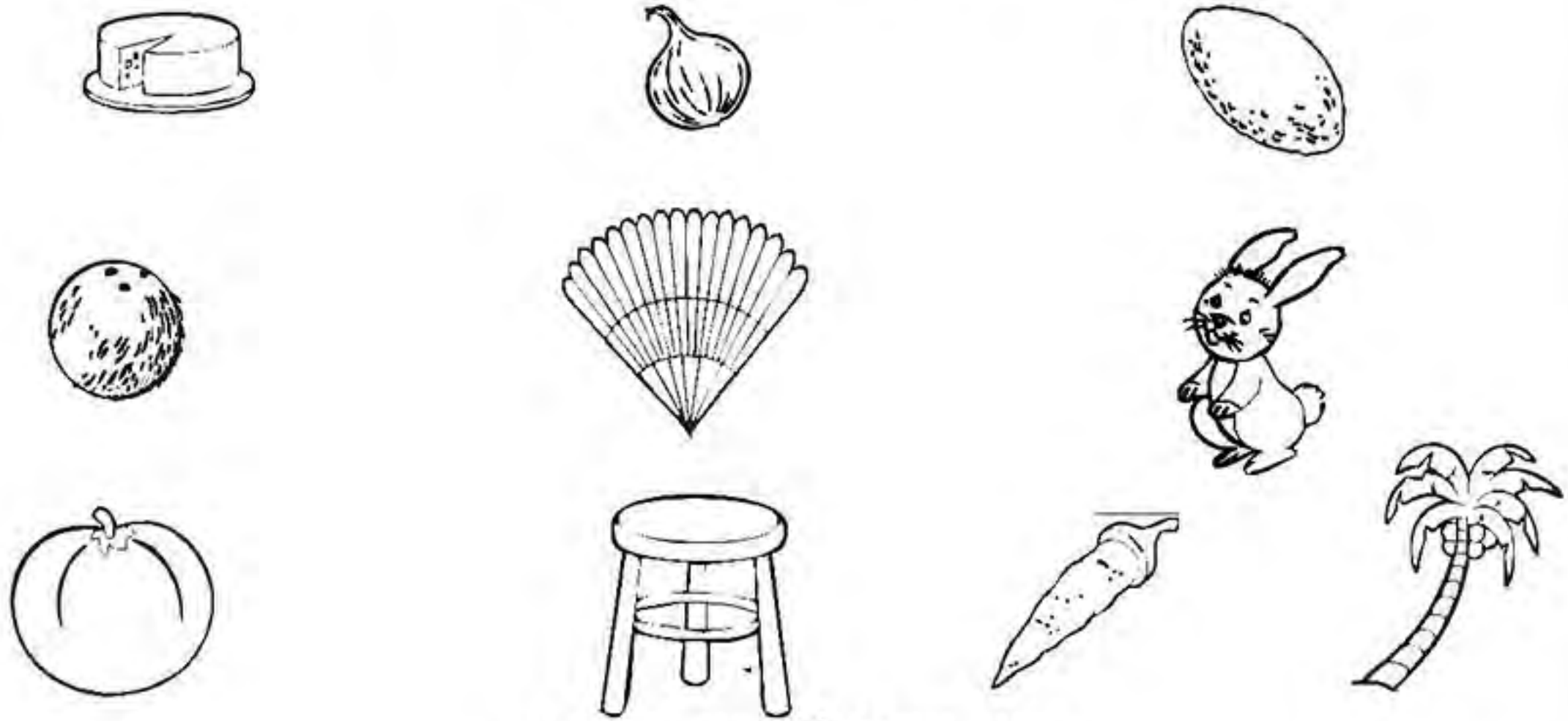

A SÍLABA **QUE** É FORMADA POR TRÊS LETRAS.  
 AO PRONUNCIÁ-LA NÃO OUVIMOS O SOM DO **U**.  
 O MESMO ACONTECE COM A SÍLABA **QUI**.

CIRCULE OS DESENHOS CUJOS NOMES  
 CONTENHAM AS SÍLABAS **QUE** E **QUI**.

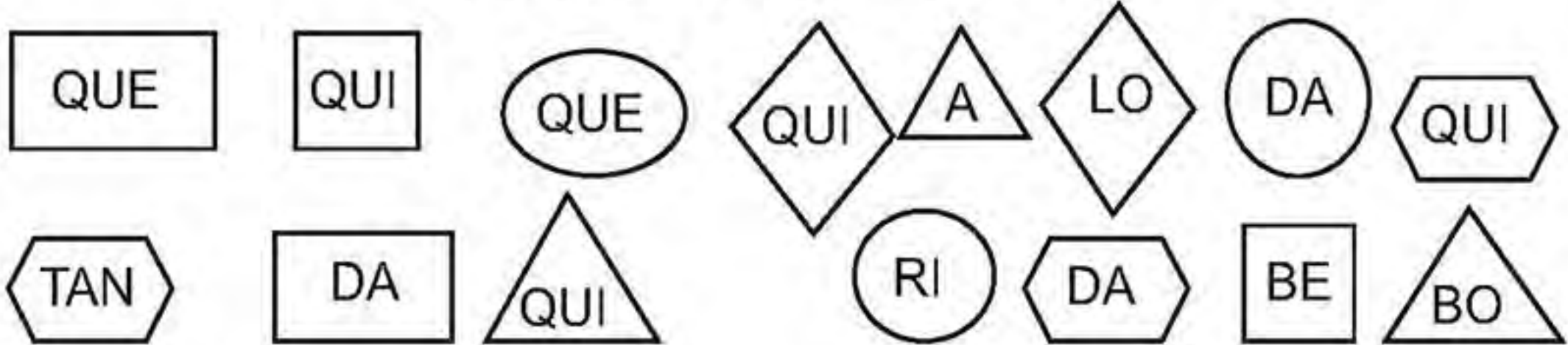

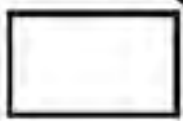
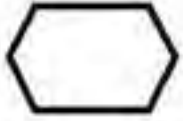
JUNTE OS SÍMBOLOS  
 IGUAIS E FORME PALAVRAS.

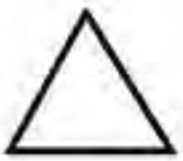

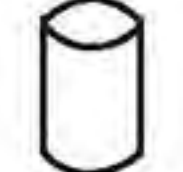
	_____		_____
	_____		_____
	_____		_____
	_____		_____

PINTE AS SÍLABAS QUE FORMAM AS PALAVRAS DOS DESENHOS E COPIE-AS.

QUI	CI
DO	A
BO	TA

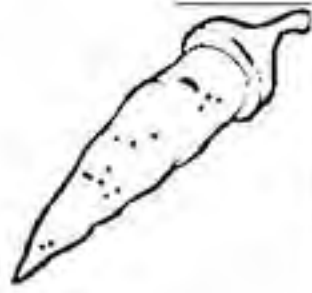

PO	CE
QUEI	BO
GO	JO

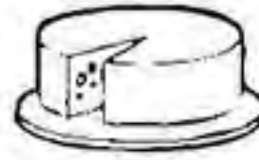

CE	LE
LO	BE
QUE	JO

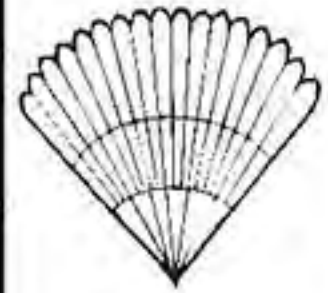

CI	SA
CA	TA
BI	QUI



BU	TO
CE	QUÊ
XO	PE



CO	O
CE	QUEI
RO	BO

BI	QUIN
ZI	DO
DIM	XA



TA	ES
QUI	BI
SE	LO



PE	TI
RI	QUI
TO	BO



LIGUE E ESCREVA AS SÍLABAS, FORMANDO PALAVRAS.

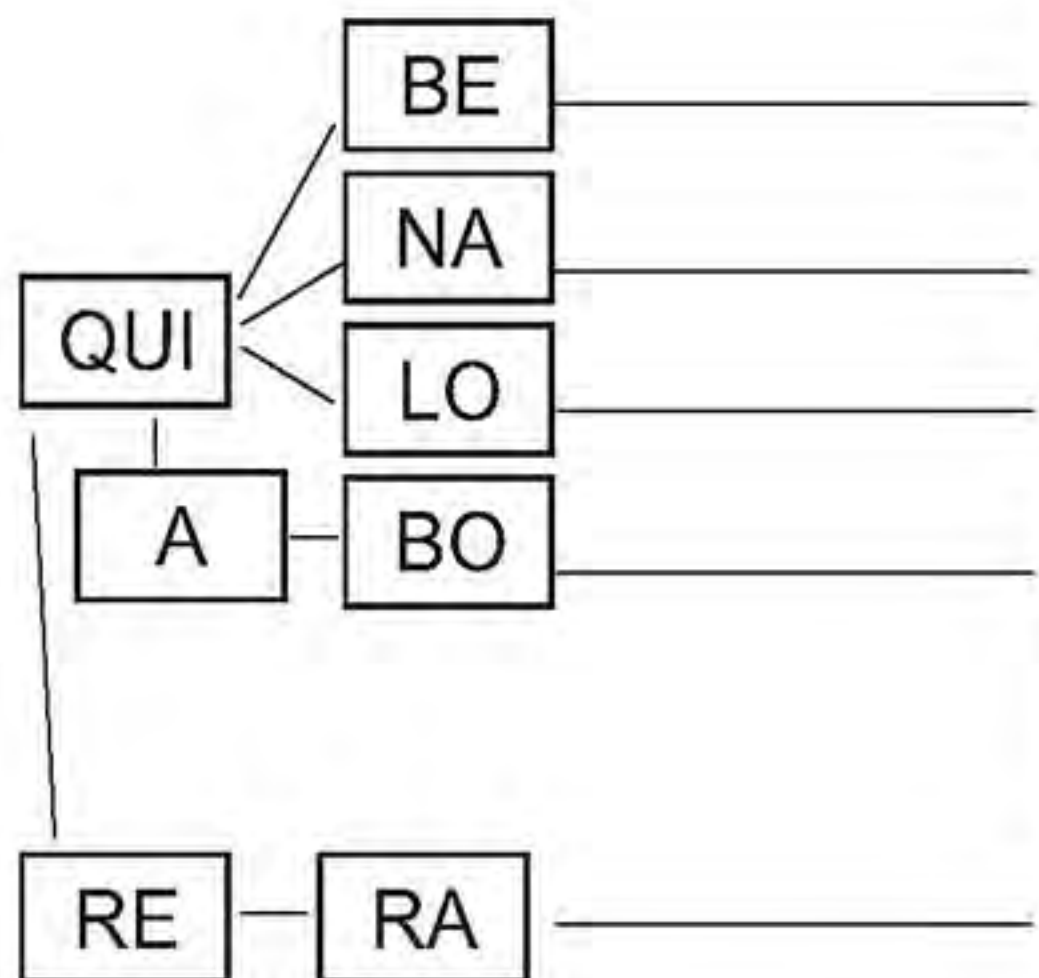
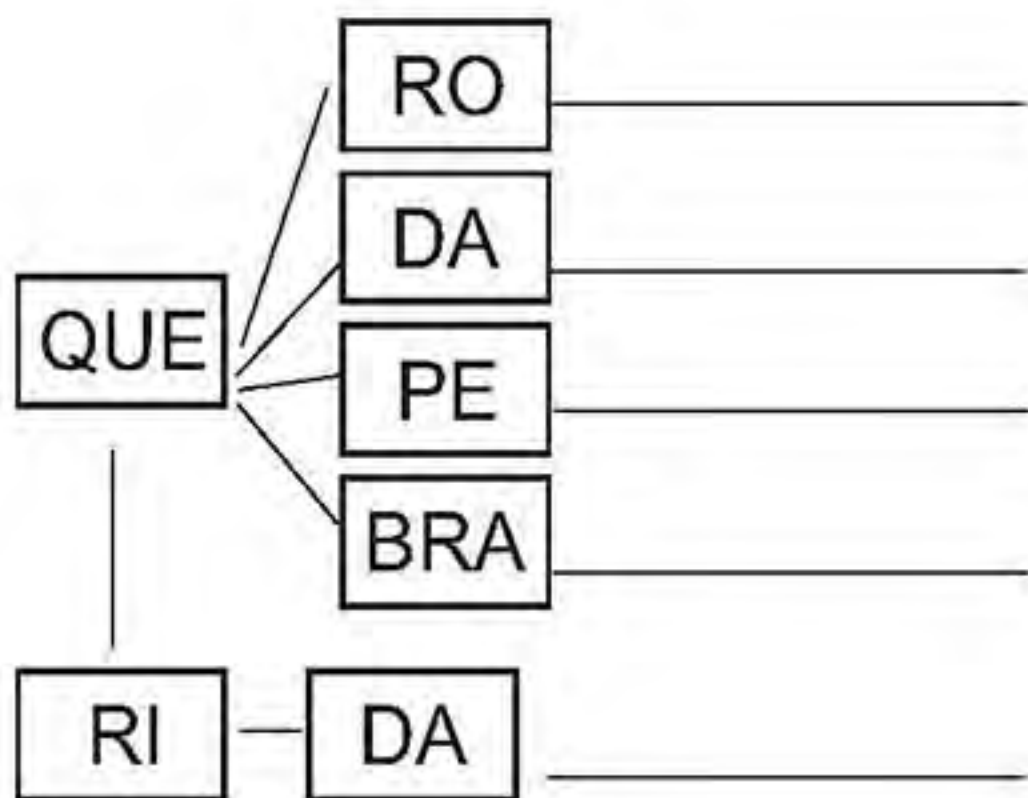

COMPLETE OS NOMES DOS DESENHOS,  
ESCREVENDO **QUE** OU **QUI**.



MÁ \_\_\_\_ NA



LE \_\_\_\_



PERI \_\_\_\_ TO



CA \_\_\_\_



BAN \_\_\_\_ TA



ES \_\_\_\_ LO

SUBSTITUA OS DESENHOS POR  
PALAVRAS E ESCREVA AS FRASES.

O

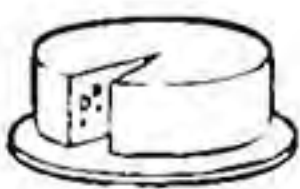

É FEITO DE LEITE.

A COZINHEIRA FEZ SALADA DE



MAMÃE FOI À FEIRA E COMPROU



O



ESTÁ NA GAIOLA.

LEIA AS PALAVRAS DO QUADRO. PINTE AS SÍLABAS **QUE** DE AMARELO E **QUI** DE VERMELHO. COPIE-AS NOS QUADROS ABAIXO, DE ACORDO COM AS SÍLABAS EM DESTAQUE.

QUIMONO	QUEROSENE	QUEIMADURA	QUIETO
QUEIXO	QUEBRADO	QUIABO	QUENTE
QUIBEBE	QUINZE	QUEDA	QUITANDA
QUEIJARIA	QUERMESSE	QUITUTE	QUEIXADA
QUILATE	QUEIXA	QUÍMICA	QUIOSQUE

**QUE**

**QUI**

ESCREVA AS PALAVRAS NO DIMINUTIVO.

BOCA - \_\_\_\_\_

BONECA - \_\_\_\_\_

FACA - \_\_\_\_\_

PIPOCA - \_\_\_\_\_

VACA - \_\_\_\_\_

COCO - \_\_\_\_\_

MACACO - \_\_\_\_\_

PORCO - \_\_\_\_\_

LEQUE - \_\_\_\_\_

QUENTE - \_\_\_\_\_

FORME PALAVRAS, COM AS SÍLABAS DOS DESENHOS, QUE CONTENHAM AS SÍLABAS **QUE** OU **QUI**.

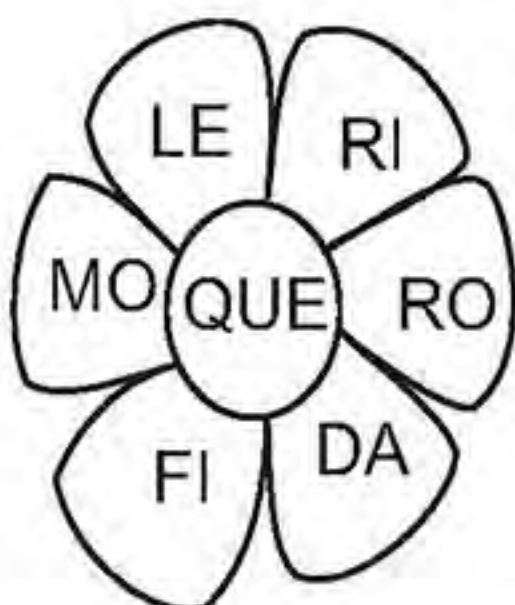

\_\_\_\_\_

\_\_\_\_\_

\_\_\_\_\_

HORA DO DITADO.

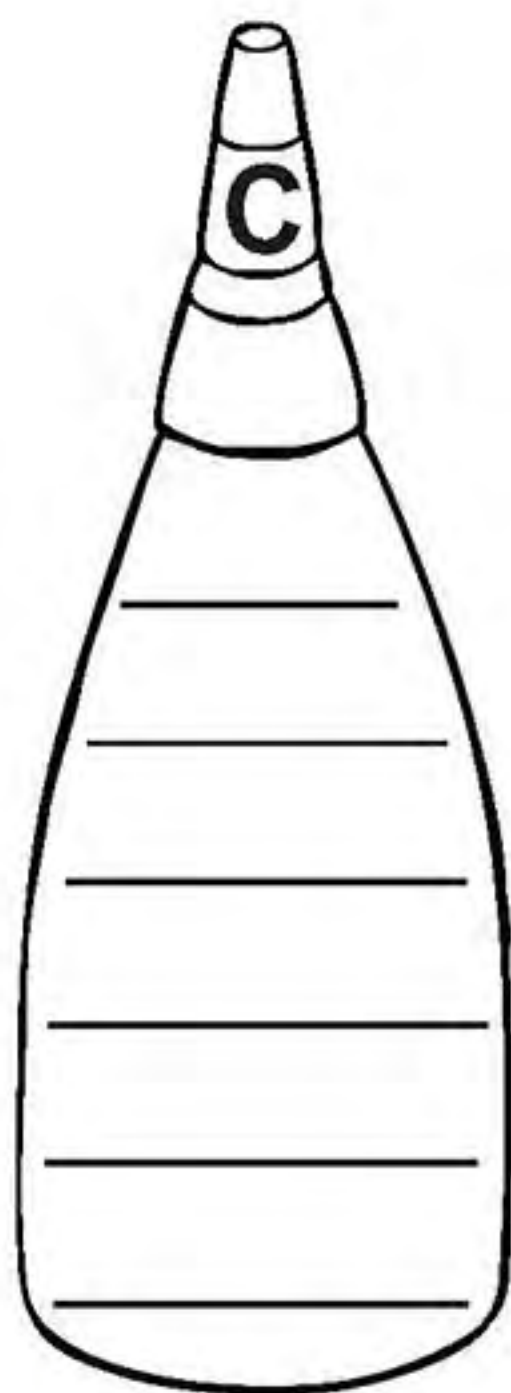
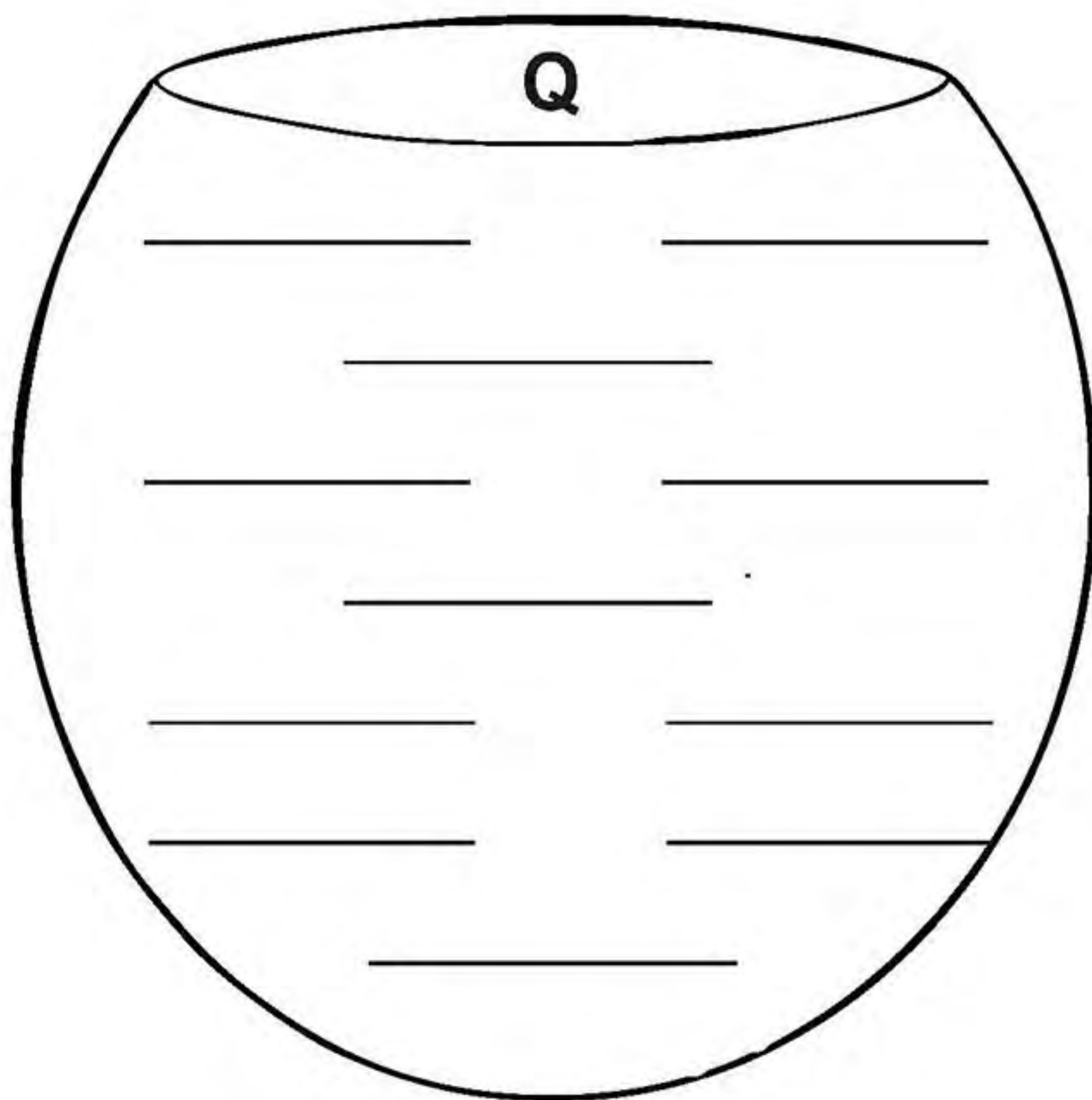

## MARCHA SOLDADO

MARCHA SOLDADO  
CABEÇA DE PAPEL.  
QUEM NÃO MARCHAR DIREITO  
VAI PRESO NO QUARTEL.



QUARTEL PEGOU FOGO  
POLÍCIA DEU SINAL.  
ACODE, ACODE, ACODE  
A BANDEIRA NACIONAL.

(CD AS MAIS BELAS CANTIGAS  
DE RODA, CIRANDA CULTURAL , pág. 9)

CIRCULE NO TEXTO ACIMA, A PALAVRA **QUARTEL**.

COPIE.

QUARTEL

quartel

quartel

Qua

qua

CIRCULE A SÍLABA **QUA**.

4      QUA    qua  
Qua  
quatro

QUATRO	AQUÁRIO
QUARTO	AQUARELA
QUARENTA	QUARTEIRÃO
QUASE	QUARTEL
QUATI	QUADRO
TAQUARA	QUALIDADE
QUANTO	QUANDO

COMPLETE AS PALAVRAS COM AS SÍLABAS **QUA** OU **QUO**.

_____LIDADE	TA_____RA	_____DRADO
_____RENTA	A_____RIO	A_____RELA
_____TI	_____DRO	_____DRA
_____TRO	_____DRILHA	_____SE

JUNTE AS SÍLABAS E FORME PALAVRAS.

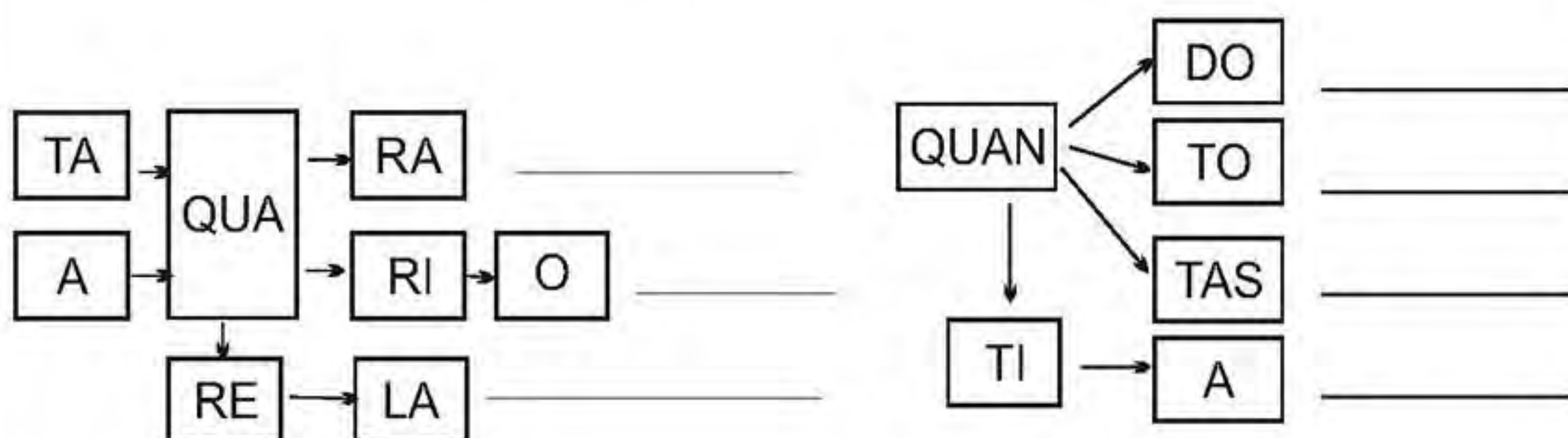

PÉ - DE - MOLEQUE	QUIRINO	TAQUARA
MOQUECA	AQUÁRIO	QUITÉRIA

O NOIVO DE QUITÉRIA É O \_\_\_\_\_.

A CESTA FOI FEITA DE \_\_\_\_\_.

O DOCE DE \_\_\_\_\_ ESTÁ QUENTE.

A \_\_\_\_\_ DE PEIXE ESTÁ DELICIOSA.

O PEIXE NADA NO \_\_\_\_\_.

\_\_\_\_\_ TEM UM LINDO LEQUE.

## VAMOS PRÁ SÃO ROQUE

TOQUE, TOQUE, TOQUE  
VAMOS PRÁ SÃO ROQUE.  
VER O MENININHO QUE VEM  
VINDO A GALOPE.



(CD CANTIGAS INFANTIS,  
CIRANDA CULTURAL, pág.148)

ASSINALE NO TEXTO AS PALAVRAS QUE TÊM  
SÍLABAS COM A LETRA **Q**.

COMPLETE AS PALAVRAS  
COM AS SÍLABAS INDICADAS.

QUE

\_\_\_PE

MU\_\_\_

TO\_\_\_

MOLE\_\_\_

BRE\_\_\_

\_\_\_DA

QUI

\_\_\_LO

\_\_\_TUTE

A\_\_\_

A\_\_\_LO

CA\_\_\_

MÁ\_\_\_NA

E\_\_\_PE

QUA

\_\_\_SE

\_\_\_DRO

\_\_\_DRADO

A\_\_\_RIO

A\_\_\_RELA

\_\_\_TRO

QUO

\_\_\_TA

A\_\_\_SO

\_\_\_RUM

ESCOLHA SEIS PALAVRAS, ESCREVA  
NAS FICHAS SEPARANDO-AS EM SÍLABAS.



LEIA E ESCREVA AS PALAVRAS DE ACORDO COM O QUE SE PEDE NO QUADRO ABAIXO.

ROQUE	ESQUILO	PEQUI	PERIQUITO
COQUINHO	MÁQUINA	QUATRO	QUITÉRIA
LEQUE	QUIRINO	CAQUI	BANQUETA
MOSQUITO	QUARENTA	QUINZE	QUATI

FRUTAS	_____ , _____ , _____
--------	-----------------------

ANIMAIS	_____ , _____ , _____
---------	-----------------------

PESSOAS	_____ , _____ , _____
---------	-----------------------

OBJETOS	_____ , _____ , _____
---------	-----------------------

NÚMEROS	_____ , _____ , _____
---------	-----------------------

SUBSTITUA OS DESENHOS PELAS PALAVRAS, E COPIE AS FRASES.

DENTRO DO  TEM UM LINDO PEIXINHO.

RAQUEL TEM  ANOS DE IDADE.

CUSTOU  REAIS O BRINQUEDO DO QUICO.

QUITÉRIA DEU RAÇÃO PARA O .

ESCREVA OS NOMES DOS DESENHOS.



4

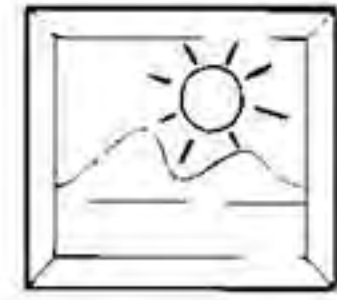

40



SUBSTITUA OS DESENHOS PELOS NOMES  
CORRESPONDENTES E COPIE AS FRASES.

ESTÁ CALOR E QUITÉRIA ABANOU-SE COM O

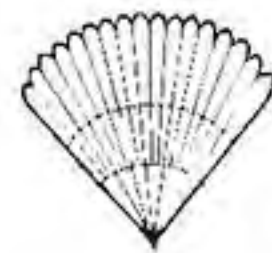

O  É UM ANIMAL MAMÍFERO.

4 e 40 SÃO NÚMEROS ESCRITOS COM A SÍLABA QUA.

O  SALGOU A PIPOCA.

**AUTODITADO.**

ESCREVA PALAVRAS, DE ACORDO  
COM A LETRA INDICADA NOS DESENHOS.

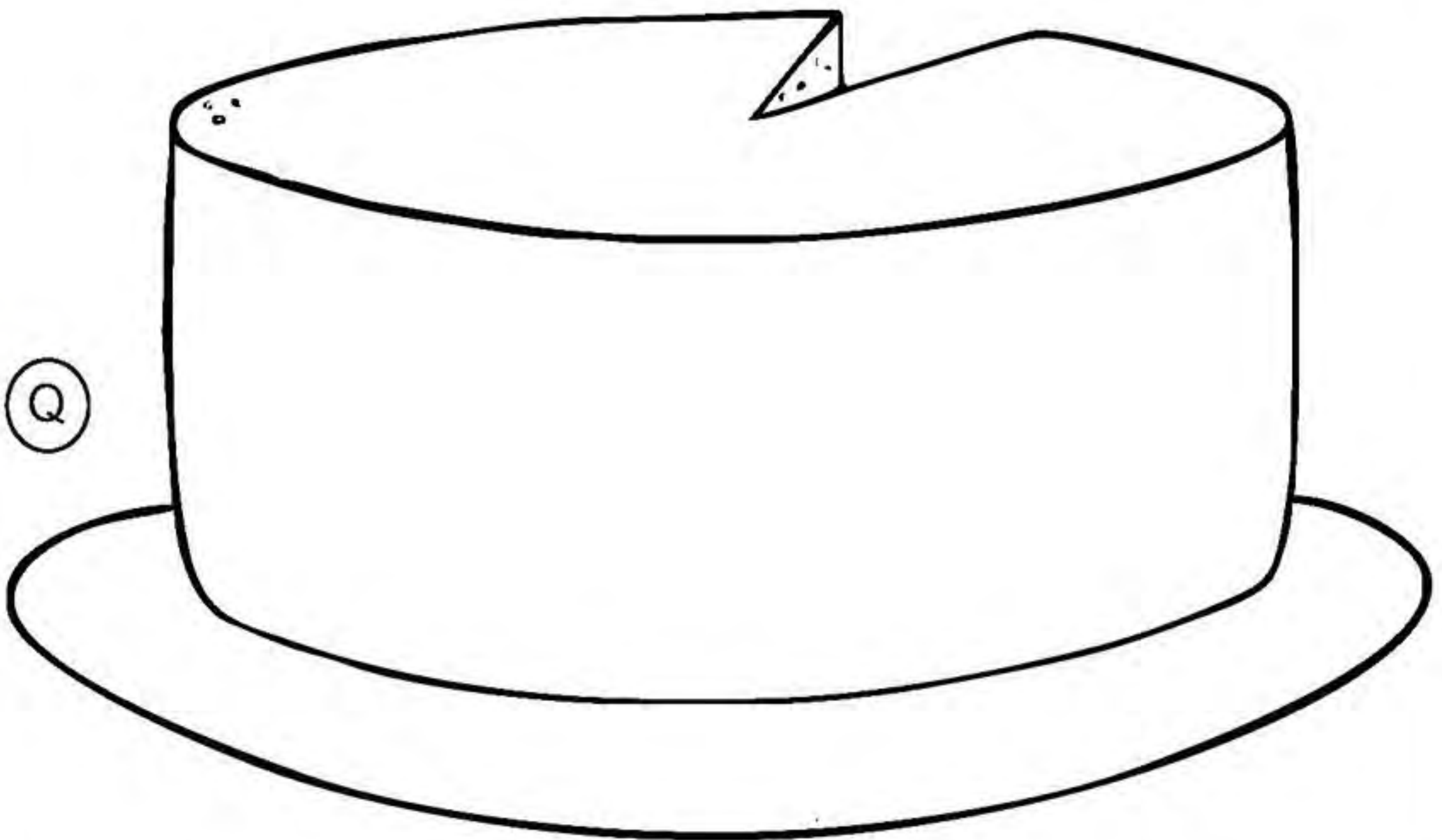
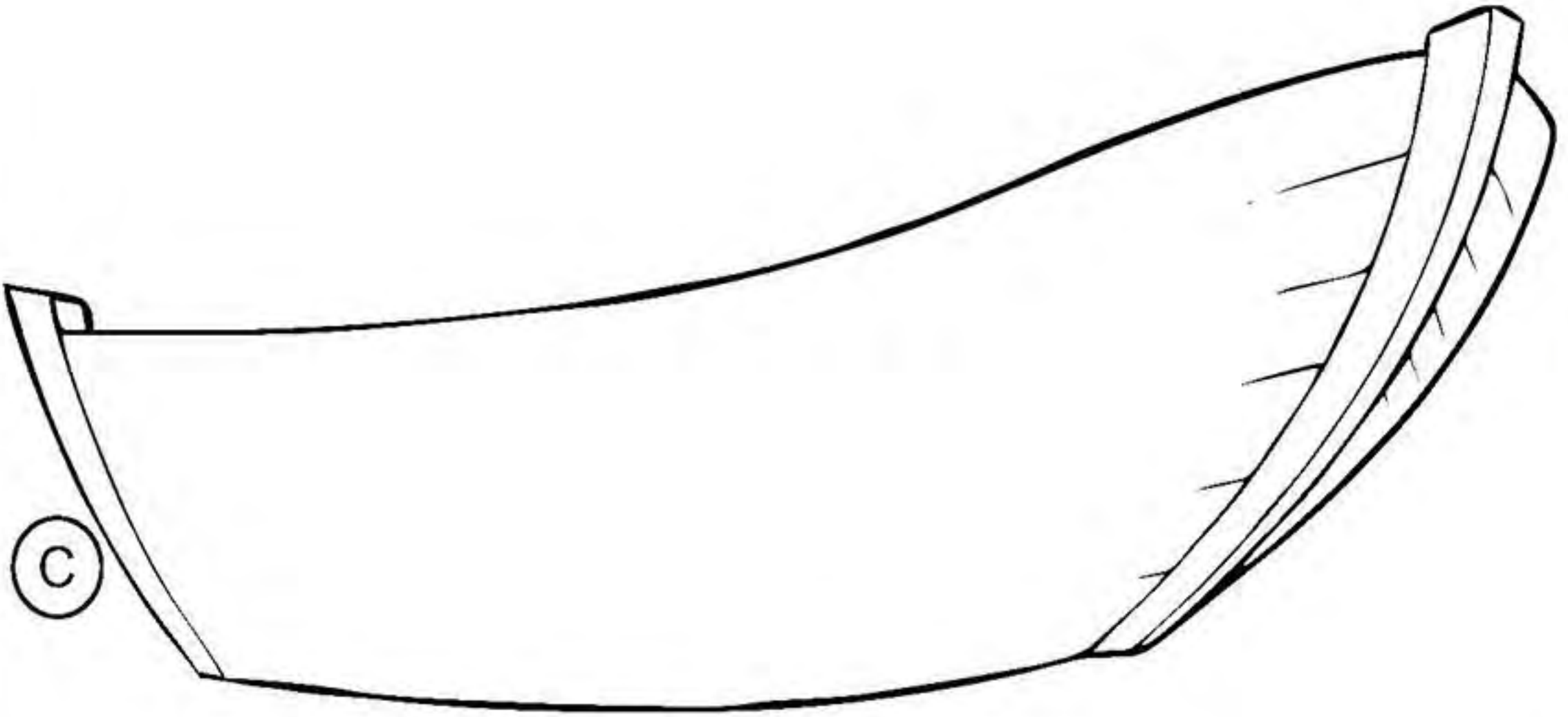

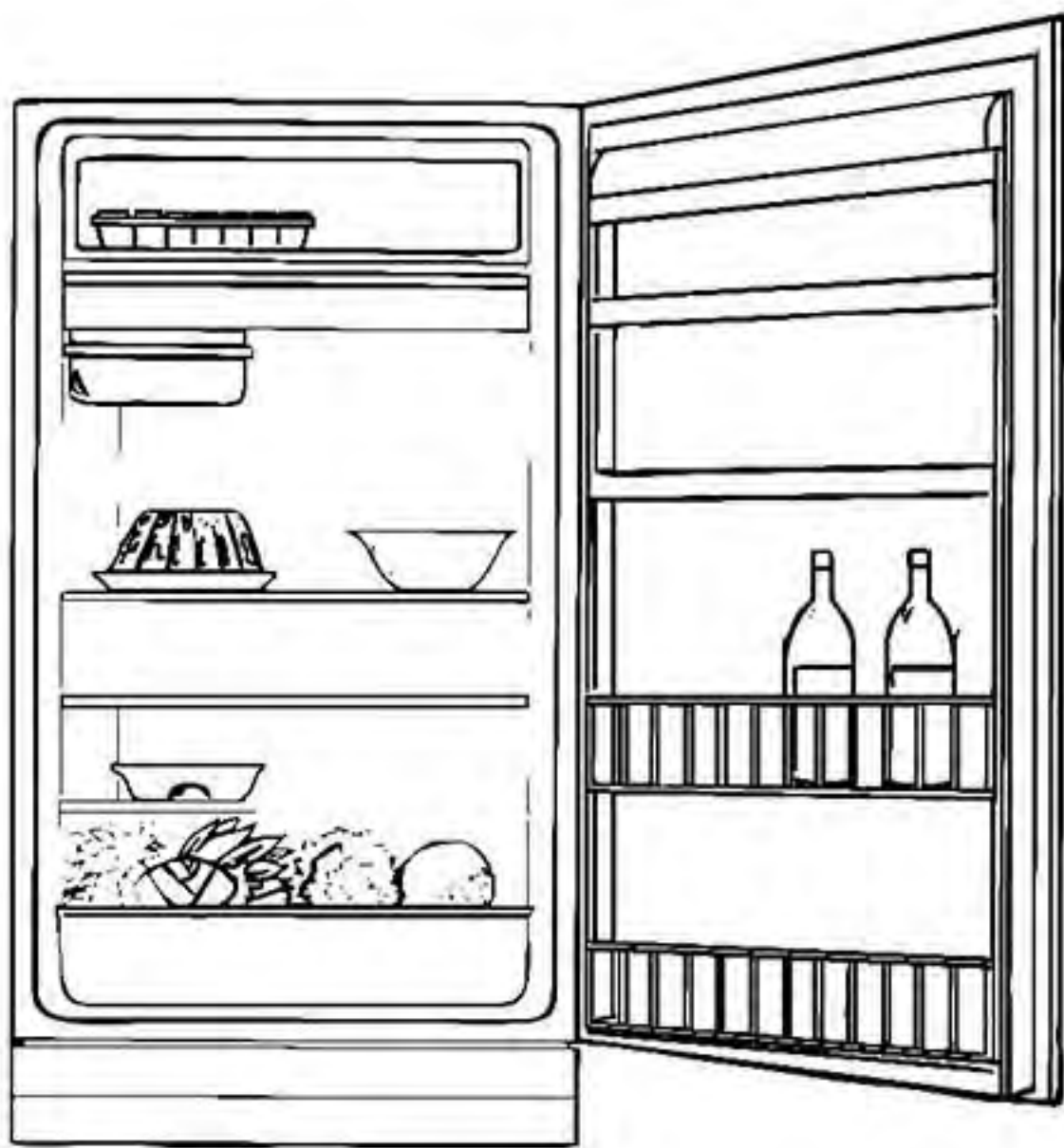

ge ge  
Ge Ge



COPIE.

GELADEIRA

geladeira

geladeira

GE - Ge

ge - ge

CIRCULE A SÍLABA **GE** NAS PALAVRAS.

GELO

GEMA

TIGELA

FOGE

GEMEU

GELADA

GELADEIRA

GERENTE

GEMIDO

GEADA

GELÉIA

GÊMEA

REFRIGERANTE

GELATINA

GEMADA

GELADO

GESSO

GENERAL

COM INVEJA DAS CRIANÇAS,  
A GIRAFA ESTICA O PESCOÇO  
E COME UMA NUVEM BRANCA,  
PENSANDO QUE É ALGODÃO  
DOCE.

A ZEBRA, A GIRAFA E OUTROS BICHOS  
MILTON CAMARGO . ED. ÁTICA - 1982



ASSINALE NO TEXTO A PALAVRA **GIRAFA**.

GIRAFA

girafa

girafa

GI - GI

gi - gi

SEPARE AS SÍLABAS DA PALAVRA **GIRAFA**.

GIRAFA

LEIA O QUE PODEMOS ESCREVER COM **GI**.

GIRA	GIRASSOL	GIGANTE	GILETE
GIRO	RELÓGIO	PÁGINA	GIBI
GIRINO	MÁGICA	MAGIA	GÍRIA
COLÉGIO	GENGIVA	REGIME	GIZ

PINTE AS SÍLABAS QUE FORMAM OS NOMES DOS DESENHOS E ESCREVA AS PALAVRAS.



CE GETO LO

GI MARA FA

GE TA LA TI NA

GI FI BI



MÁ GI DO CO

GI BE LE TE

GI RAS NO SOL

RE LÓ RI GIO



TI DI GEL A

CO GENE MA

VA TA GEM ME

PINTE SOMENTE OS DESENHOS QUE TÊM AS SÍLABAS **GE** E **GI** NAS PALAVRAS.



FORME PALAVRAS.

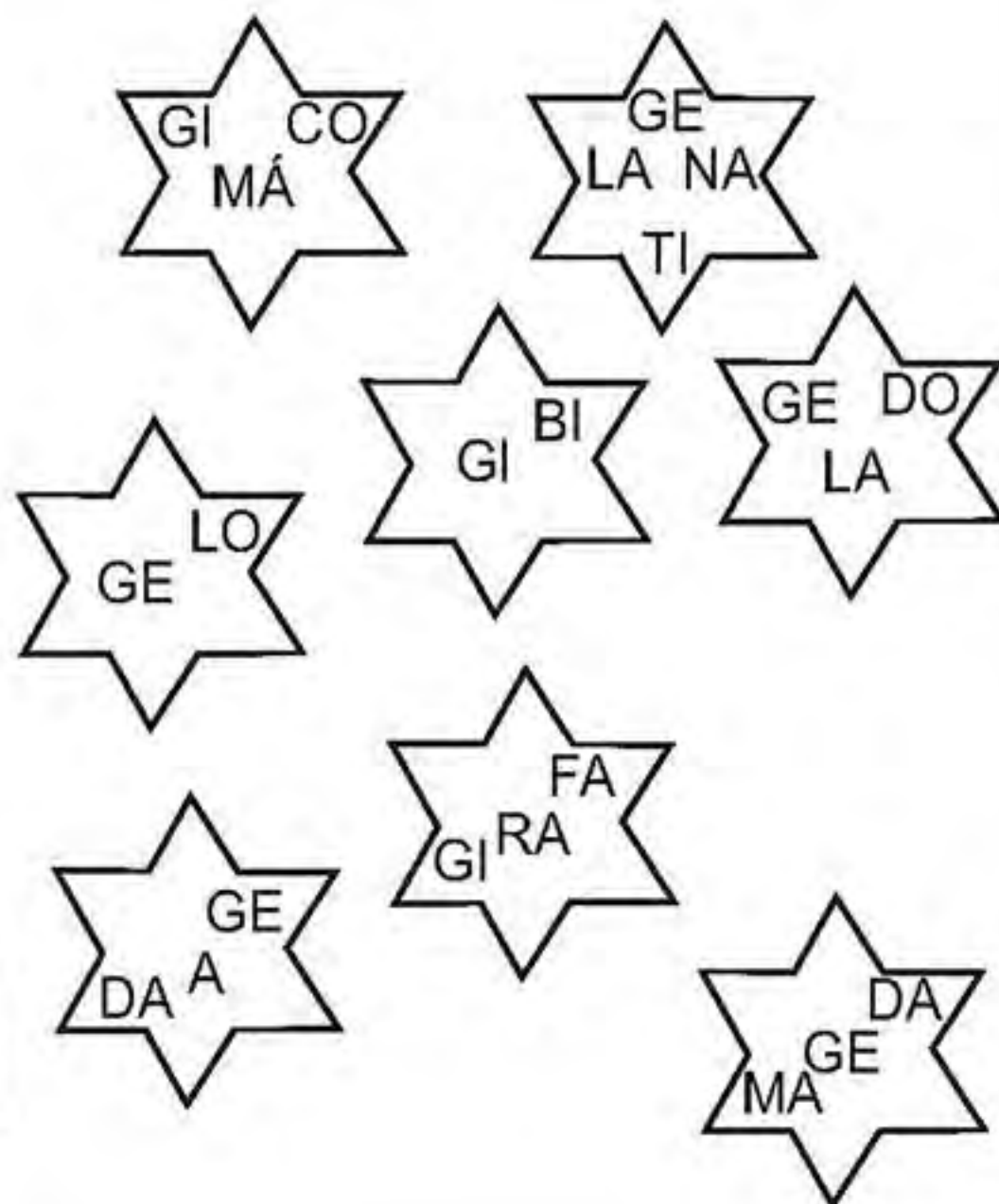

\_\_\_\_\_

\_\_\_\_\_

\_\_\_\_\_

COMPLETE AS SÍLABAS QUE FALTAM NAS PALAVRAS.

_____ LO	_____ MADA	_____ RA	_____ LETE
MÁ _____ CO	MA _____ A	_____ LATINA	_____ LADO
_____ MIDO	_____ MA	_____ GANTE	_____ NÁSIO
A _____ LIDADE	_____ ENTE	RELÓ _____ O	TI _____ LA
_____ RASSOL	_____ LADEIRA	_____ BI	MÁ _____ CA

FORME PALAVRAS, JUNTANDO OS SÍMBOLOS IGUAIS.

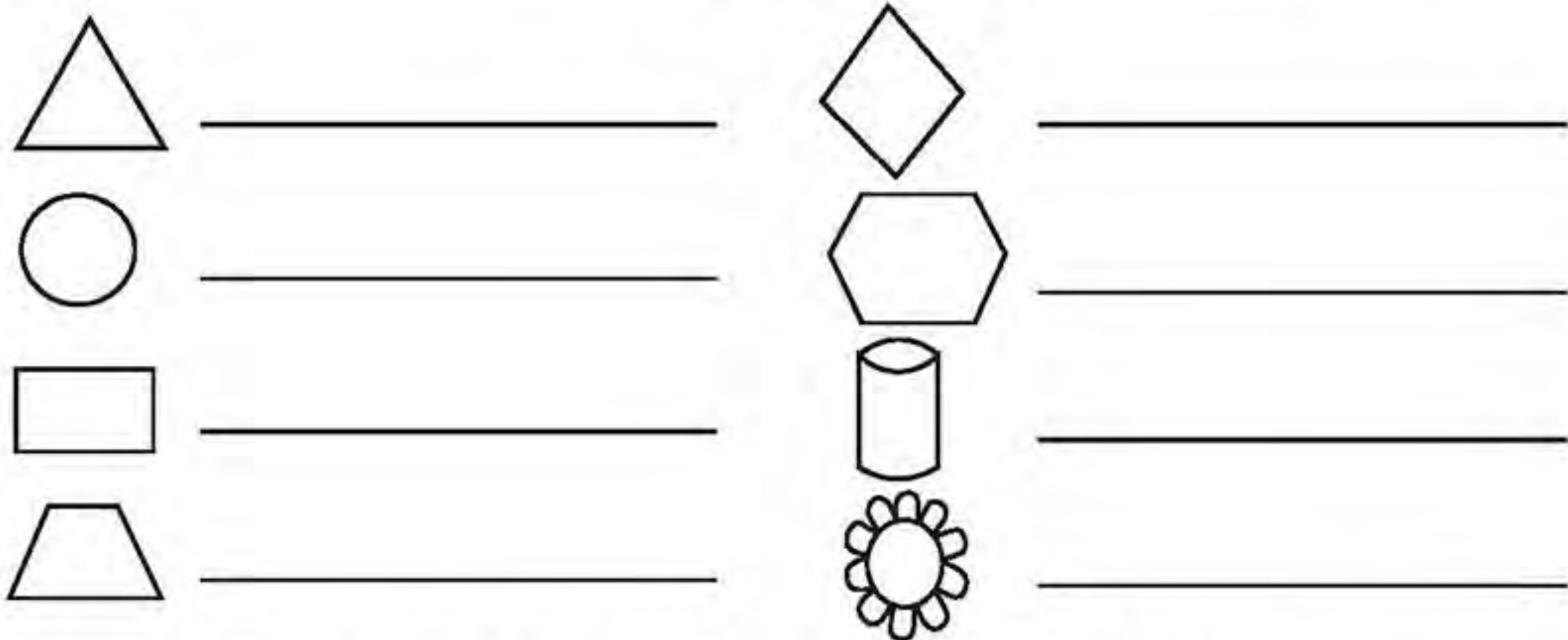
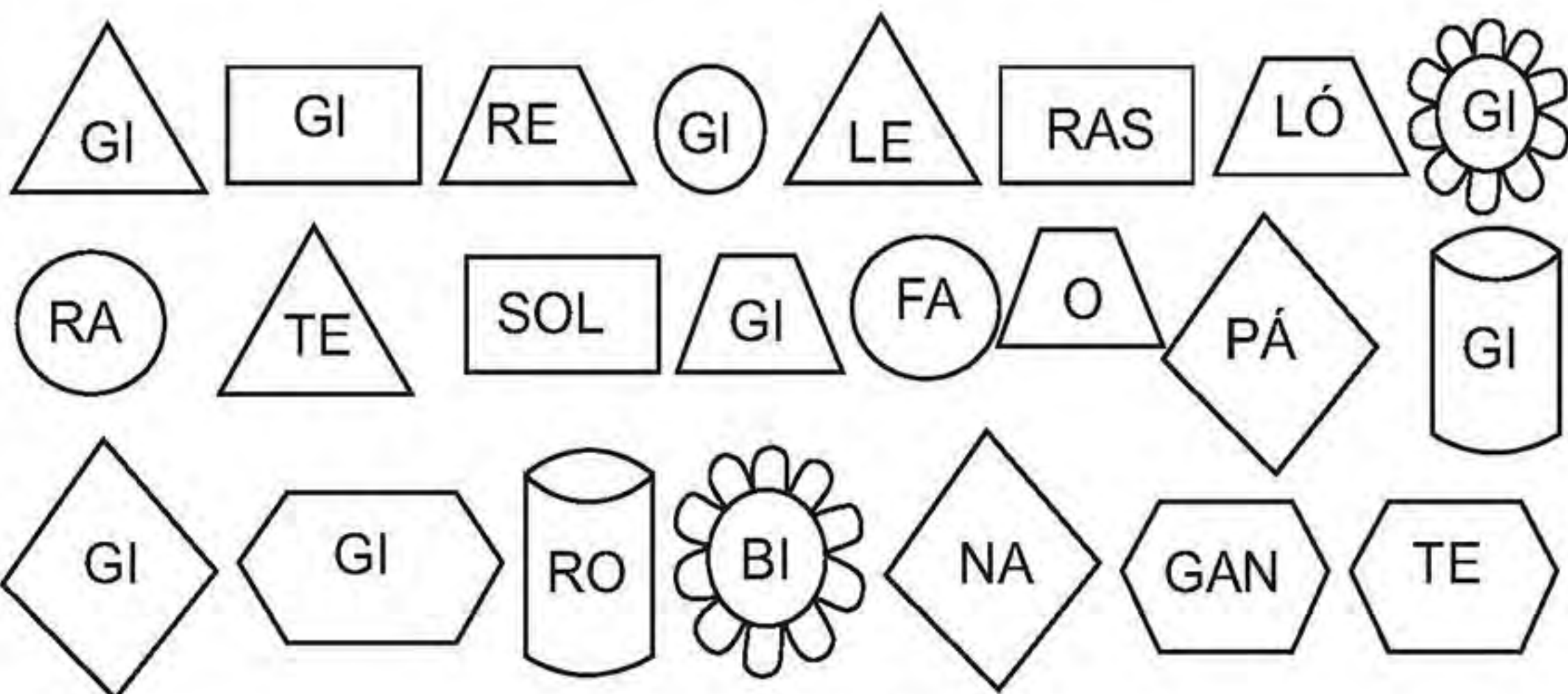

LIGUE AS SÍLABAS FORMANDO PALAVRAS.

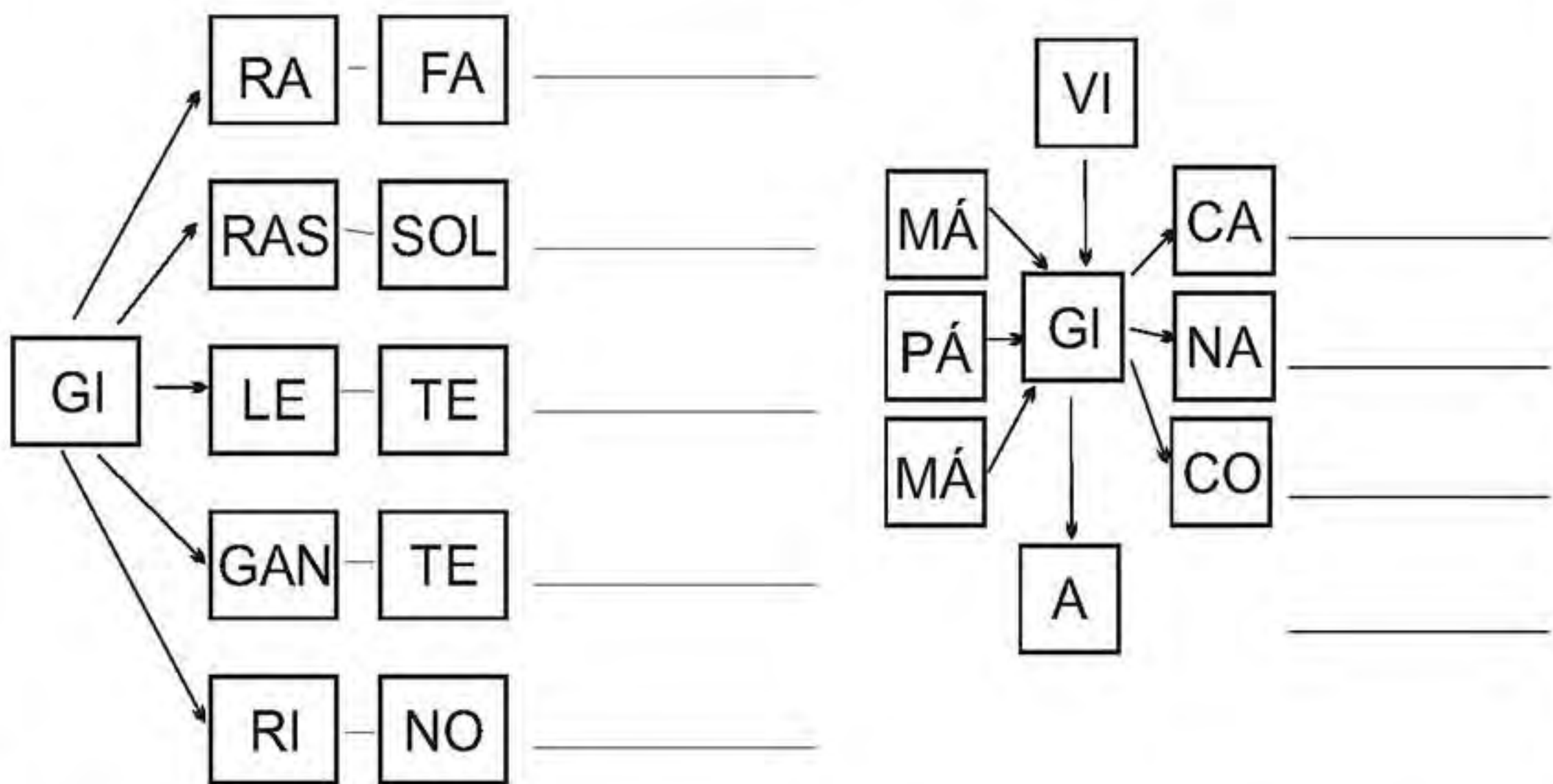



COMPLETE COM AS LETRAS **J** OU **G**.

\_\_\_ ECA    \_\_\_ ATO    \_\_\_ EADA  
\_\_\_ ELO    \_\_\_ IBI    \_\_\_ EMA  
\_\_\_ IRAFA    \_\_\_ ACA    \_\_\_ ELADEIRA  
\_\_\_ EITO    \_\_\_ IRO    \_\_\_ ABÁ  
\_\_\_ OIABA    \_\_\_ ILETE    \_\_\_ IBÓIA  
\_\_\_ IPE    \_\_\_ ILÓ    \_\_\_ IGANTE

FORME PALAVRAS COM AS SÍLABAS  
ESCONDIDAS NAS PINTAS DA GIRAFA.

\_\_\_\_\_

\_\_\_\_\_

\_\_\_\_\_

\_\_\_\_\_

\_\_\_\_\_

\_\_\_\_\_

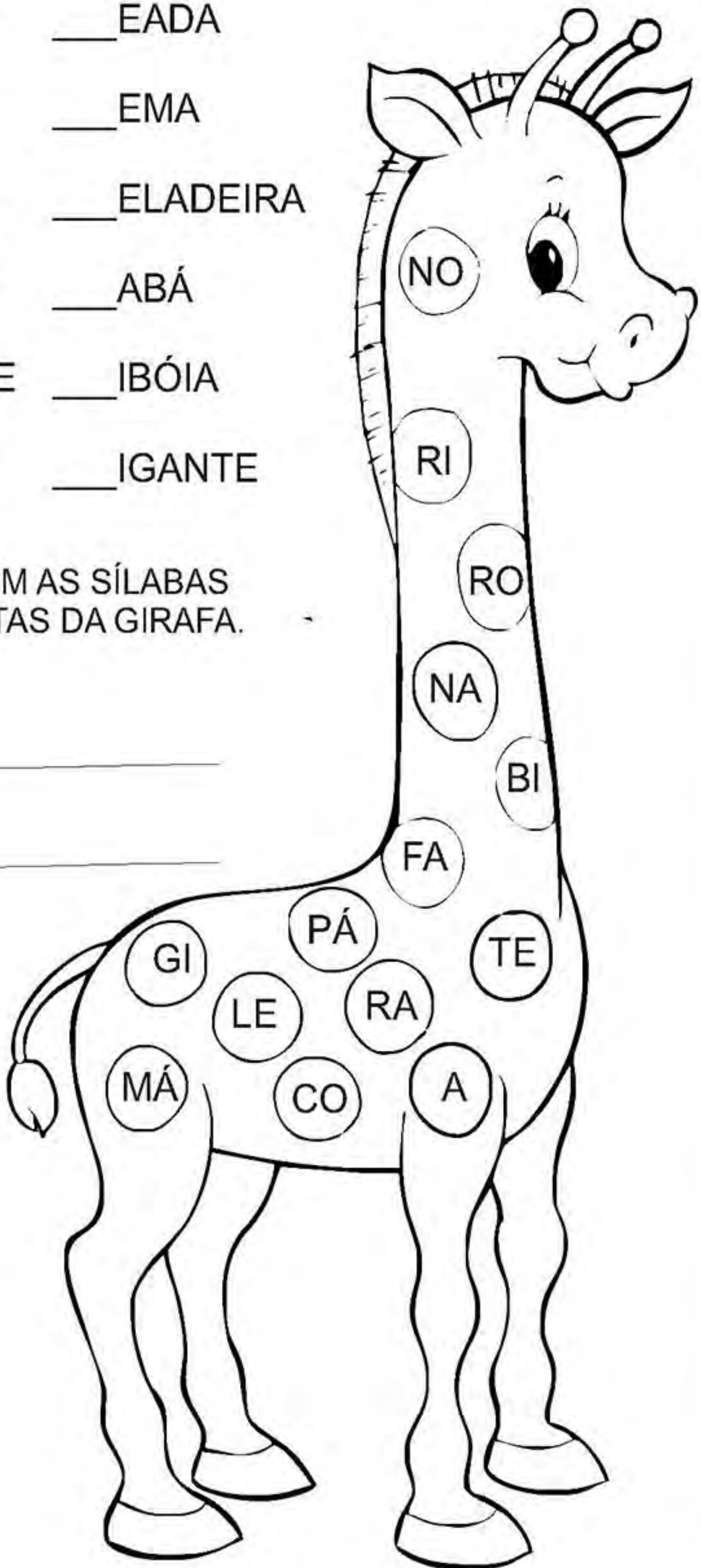

CRUZA-PALAVRAS.

GIBI

TIGELA

RELÓGIO

GELO

GELADEIRA

GEMA

GIRAFA

MÁGICO

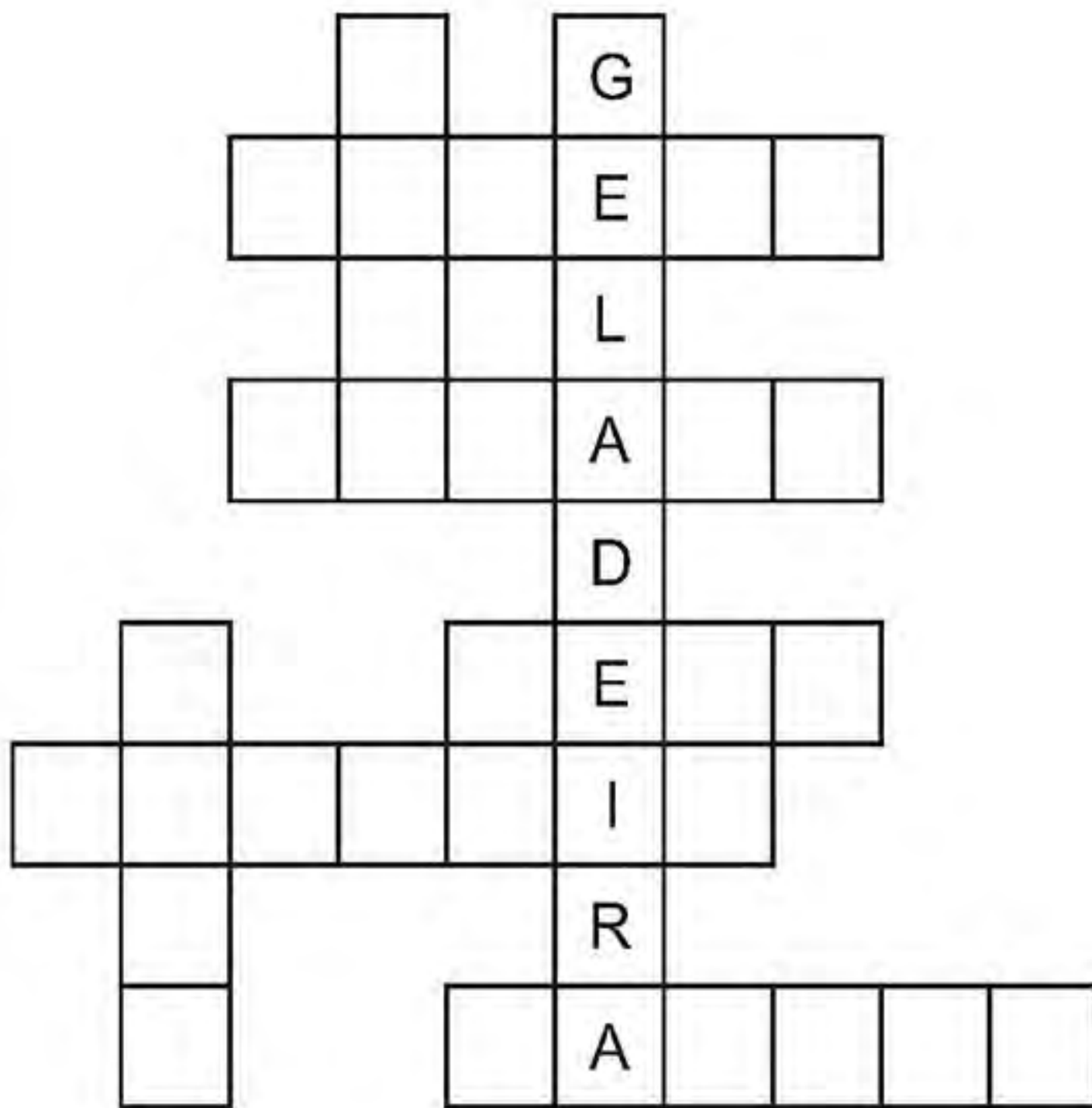

SUBSTITUA OS DESENHOS PELAS PALAVRAS CORRESPONDENTES E ESCREVA AS FRASES.

A



DO OVO É AMARELA.

A



TEM O PESCOÇO COMPRIDO.

GIGI FEZ



DE ABACAXI.

O NOME DO



É ROGÉRIO.

ADIVINHE.

SOU FEITO DE ÁGUA, MAS SE NELA VOCÊ ME JOGAR COM CERTEZA NÃO VAI ME ACHAR.

(O GELO)

LEIA AS PALAVRAS E ESCREVA NOS DESENHOS,  
OBSERVANDO AS SÍLABAS INDICADAS.

GEADA	GÍRIA	COLÉGIO	GIRO
REGIME	GESTO	AGILIDADE	GESSO
VAGEM	MUGIDO	GEMIDO	GENGIVA

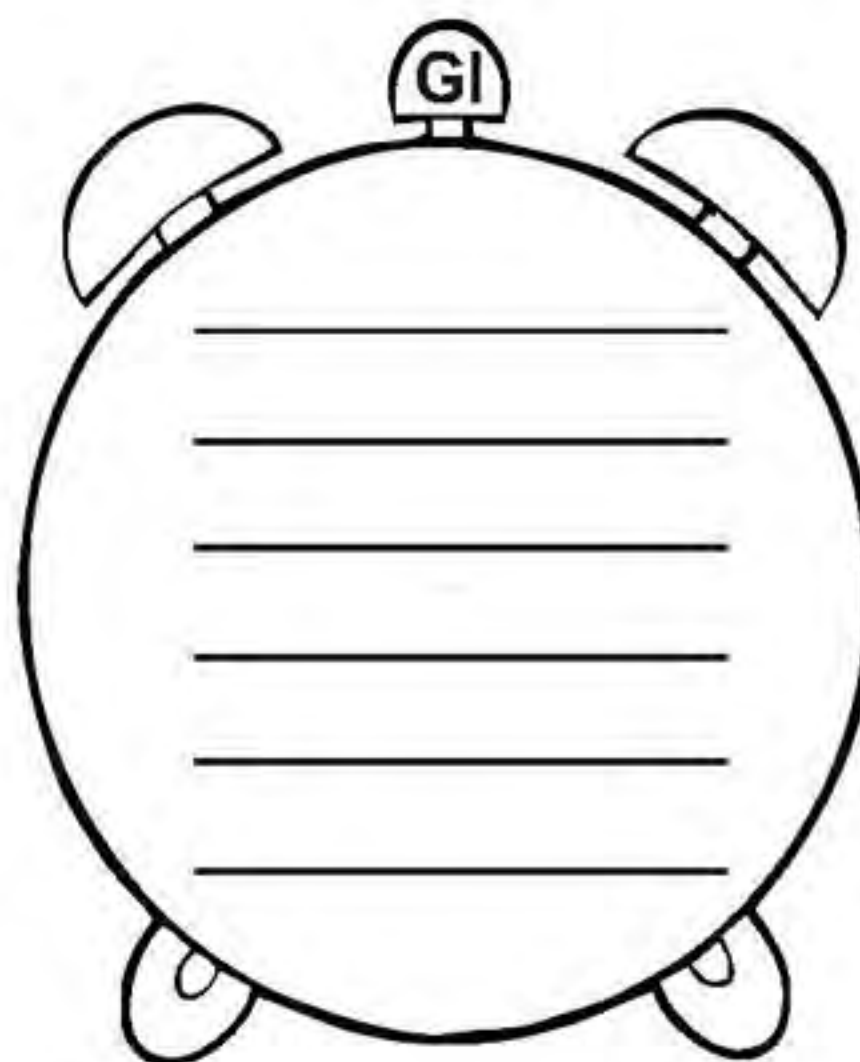
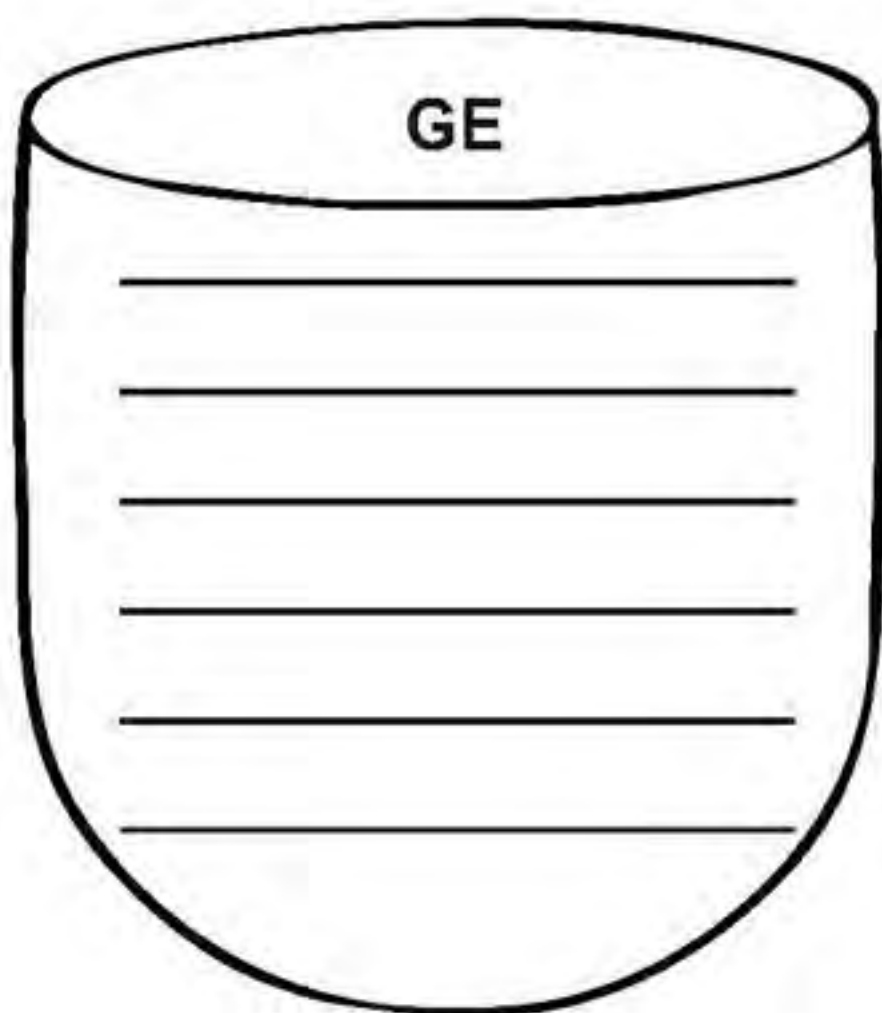

COMPLETE AS PALAVRAS COM **GE** OU **GI**.  
DEPOIS, SEPRE-AS EM SÍLABAS.

__MADA		

MÁ__CA		

__LETE		

__LÉIA		

__LADEIRA			

TI__LA		

VI__A		

RELÓ__O			

__ADA		

ZOOLÓ__CO				

__MIDO		

__RAFA		

ADIVINHE:  
GIRA, GIRA E NÃO PODE PARAR.  
GIRA, GIRA E NÃO SAI DO LUGAR.

(O RELÓGIO)

LEIA AS PALAVRAS DO QUADRO E  
ESCREVA-AS NAS FRASES ABAIXO.

GEMA	GIRASSOL	MÁGICO	PÁGINA
GELO	GILETE	GIRAFA	RELÓGIO

TODO LIVRO TEM \_\_\_\_\_.

O PAPAÍ USA A \_\_\_\_\_ PARA FAZER A BARBA.

O \_\_\_\_\_ É UMA FLOR AMARELA.

MEU \_\_\_\_\_ ESTÁ SEM BATERIA.

O OVO TEM A CLARA E A \_\_\_\_\_.

O \_\_\_\_\_ DA GELADEIRA DERRETEU.

GIGI É O NOME DA \_\_\_\_\_ DO ZOOLOGICO.

QUEM FAZ MÁGICAS É O \_\_\_\_\_.

CAÇA-PALAVRAS



W	Y	K	G	E	M	A	Q
T	Z	G	E	L	O	R	G
I	B	I	L	K	P	S	I
G	I	R	A	S	S	O	L
E	C	A	T	J	T	V	E
L	D	F	I	L	X	Z	T
A	H	A	N	W	K	K	E
F	M	N	A	Y	G	I	Z
A	E	B	F	C	G	D	H



GEMA	GIRASSOL	GELATINA	GIZ
GILETE	TIGELA	GIRAFA	GELO

AUTODITADO.

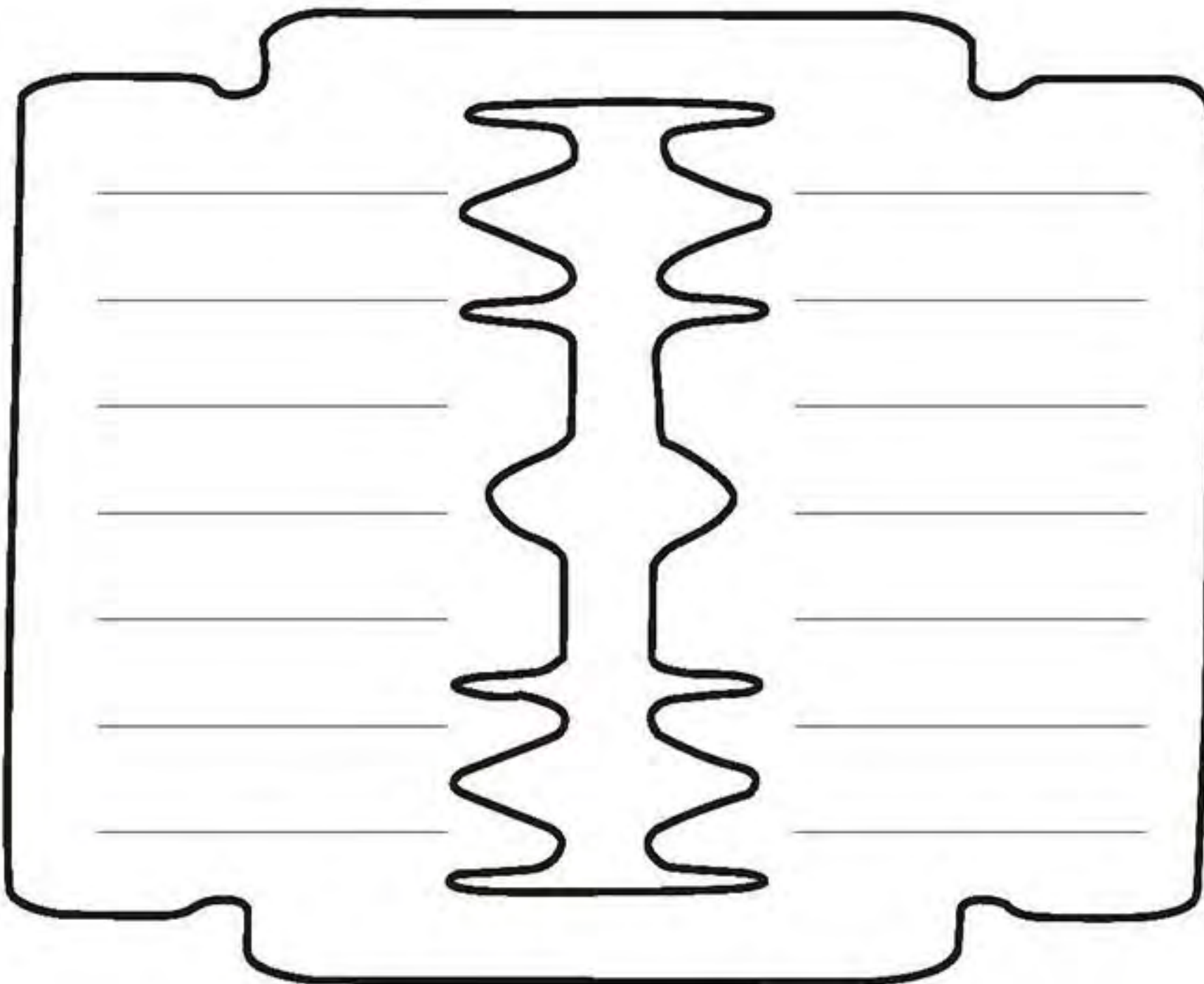

## CARANGUEJO

CARANGUEJO NÃO É PEIXE,  
CARANGUEJO PEIXE É.  
CARANGUEJO SÓ É PEIXE  
NA ENCHENTE DA MARÉ.  
ORA PALMA, PALMA, PALMA  
ORA PÉ, PÉ, PÉ.  
ORA RODA, RODA, RODA,  
CARANGUEJO PEIXE É.



CD CANTIGAS INFANTIS,  
CIRANDA CULTURAL pág.102)

CIRCULE NO TEXTO A PALAVRA **CARANGUEJO**.

COPIE.

CARANGUEJO

caranguejo

caranguejo

gue - gue

GUE - Gue

foguete

foqueira

acougue

guerreiro

guelxa

guerra

mangue

figueira

gueto

gue

gue

GUE

Gue

BOM DIA, AMIGUINHO, COMO VAI?

BOM DIA, AMIGUINHO, COMO VAI?

A NOSSA AMIZADE NUNCA SAI.

FAREMOS O POSSÍVEL PARA

SERMOS BONS AMIGOS.

COMO VAI, AMIGUINHO, COMO VAI?



(CD AS MAIS BELAS CANTIGAS DE RODA,  
CIRANDA CULTURAL, pág.27.)

CIRCULE NO TEXTO, A PALAVRA **AMIGUINHO**.

COPIE.

AMIGUINHO

amiguinho

amiguinho

gui - gui

GUI - Gui

guia

guisado

guiné

quichê

GUIDO

guincho

guirlanda

guizo

amiguinho

GUILHERME

águia

gui

gui

GUI

Gui

LEIA AS PALAVRAS E COPIE-AS, NO QUADRO INDICADO, DE ACORDO COM AS SÍLABAS **GUE** E **GUI**.

GUIA	FOGUETE	ALGUÉM	MANGUEIRA
GUERRA	GUIZO	GUIOMAR	SANGUE
ÁGUIA	AÇOUGUE	GUISADO	FOGUEIRA
FORMIGUEIRO	GUINDASTE	FIGUEIRA	GUITARRA

**GUE**

**GUI**

ESCREVA AS PALAVRAS DESTACADAS, NO LUGAR CORRETO.

COLEGUINHA - GUIZINHO - FOGUINHO - AMIGUINHO
JOGUINHO - GUISADINHO - GUITARRINHA - FOGUETINHO

AMIGO \_\_\_\_\_  
 GUIZO \_\_\_\_\_  
 FOGUETE \_\_\_\_\_  
 GUISADO \_\_\_\_\_





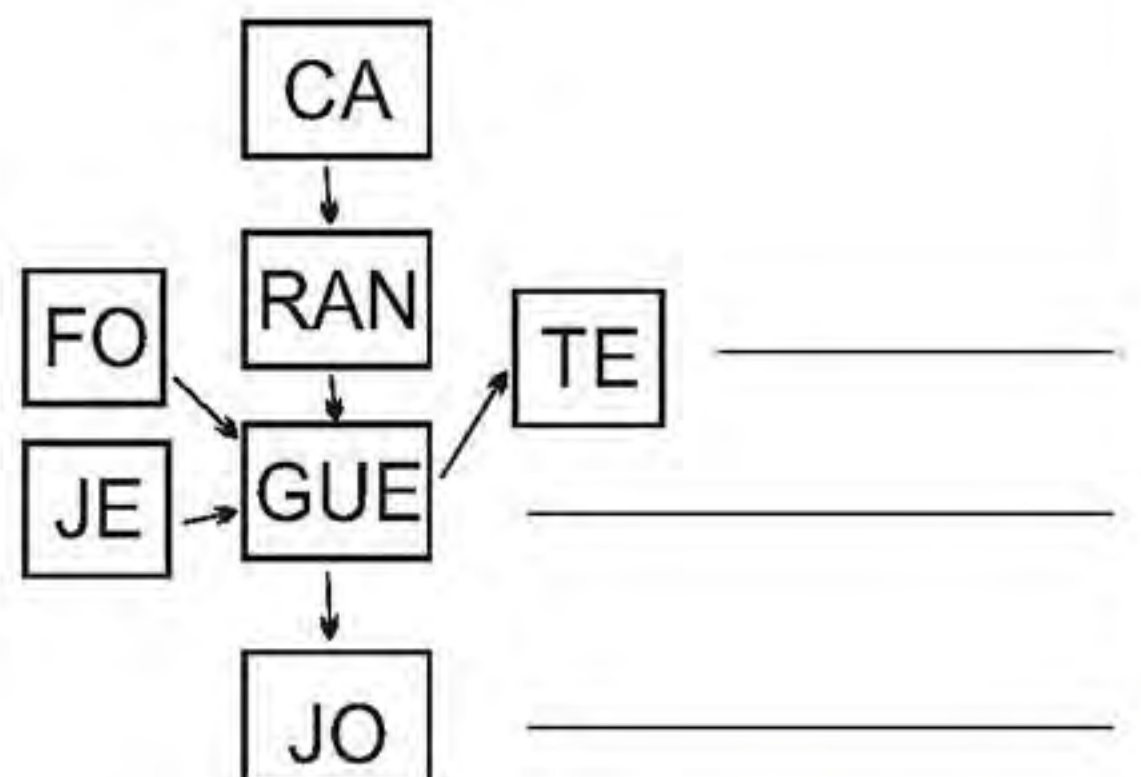
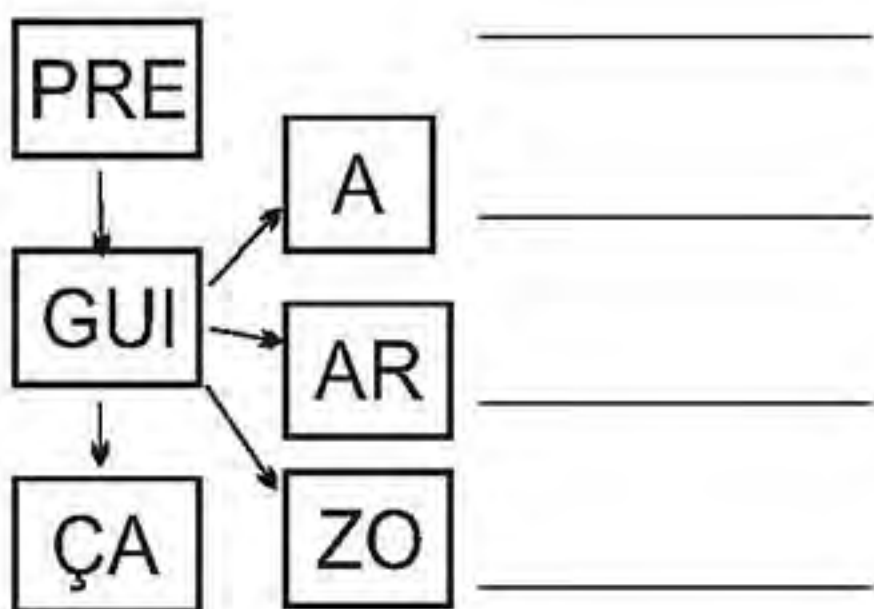









FOGO \_\_\_\_\_  
 COLEGA \_\_\_\_\_  
 JOGO \_\_\_\_\_  
 GUITARRA \_\_\_\_\_

LIGUE.





PINTE OS DESENHOS QUE TÊM NO NOME A SÍLABA EM DESTAQUE.

GUE					
GUI					
GUA					

LIGUE E FORME PALAVRAS.

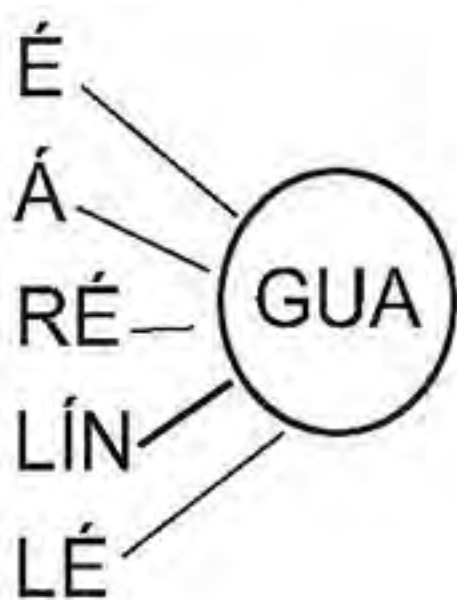

\_\_\_\_\_

\_\_\_\_\_

\_\_\_\_\_

\_\_\_\_\_

\_\_\_\_\_

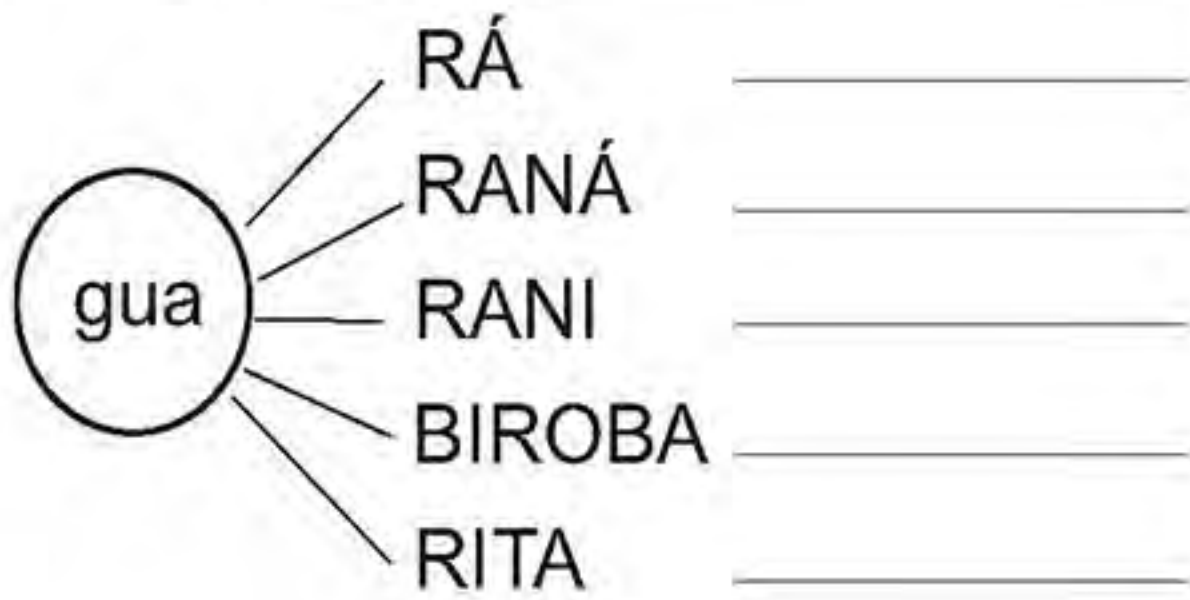

\_\_\_\_\_

\_\_\_\_\_

\_\_\_\_\_

\_\_\_\_\_

\_\_\_\_\_

JE	JO
FO	TE

que

\_\_\_\_\_

\_\_\_\_\_

\_\_\_\_\_

\_\_\_\_\_

\_\_\_\_\_

FI	FO
MAN	RA

qui

\_\_\_\_\_

\_\_\_\_\_

\_\_\_\_\_

\_\_\_\_\_

\_\_\_\_\_

A	PRE
MI	NHO
PRE	ÇA

qui

\_\_\_\_\_

\_\_\_\_\_

\_\_\_\_\_

\_\_\_\_\_

\_\_\_\_\_

COMPLETE AS FRASES COM  
A PALAVRA ADEQUADA.

JOGUINHO - GUITARRA - GUARITA

GUIDO GOSTA DE TOCAR \_\_\_\_\_.

GUERRA - QUIABO - GUISADO

AGUINALDO COMEU TODO O \_\_\_\_\_ DE CARNE.

AÇOUGUE - MANGUE - SANGUE

OS CARANGUEJOS GOSTAM DE MORAR NO \_\_\_\_\_.

GUIZO - GUITARRA - RÉGUA

O GATO GUIGUI TEM UM \_\_\_\_\_ NO PESCOÇO.

CARANGUEJO - SAGUÃO - GUARANI

O \_\_\_\_\_ DO HOTEL ESTÁ TODO ENFEITADO.

ÁGUIA - ÉGUA - ÁGUA

DEVEMOS FILTRAR A \_\_\_\_\_ PARA BEBER.

COMPLETE AS PALAVRAS.

GUE

CARAN\_\_JO

AL\_\_M

SAN\_\_

\_\_RRA

AÇOU\_\_

FO\_\_IRA

MAN\_\_IRA

FI\_\_IRA

JE\_\_

GUI

Á\_\_A

\_\_NDASTE

\_\_A

\_\_TARRA

AMI\_\_NHO

\_\_ZO

\_\_SADO

ES\_\_CHO

JO\_\_NHO

GUA

Á\_\_

RÉ\_\_

\_\_RDA

\_\_RANÁ

É\_\_

\_\_RITA

LÍN\_\_

\_\_RANI

ESCREVA AS FRASES SUBSTITUINDO  
OS DESENHOS POR PALAVRAS.

VOVÔ REGA O JARDIM COM A



A



ESTÁ CARREGADA DE MANGAS MADURAS.

O



CUIDA DO TRÂNSITO.

O



VIVE NO MANGUE.

SEPARE AS PALAVRAS EM SÍLABAS E COPIE-AS.

FOGUETE

GITARRA

GUERRA

MANGUEIRA

GUIZO

JOGUINHO

JEGUE

SANGUE

COMPLETE AS EXPRESSÕES.

(PROFESSOR, DISCUTA COM AS CRIANÇAS A  
DIFERENÇA ENTRE CADA EXPRESSÃO).

\_\_\_\_\_ - CHUVA  
\_\_\_\_\_ - ROUPA  
\_\_\_\_\_ - COMIDA  
\_\_\_\_\_ - SOL  
\_\_\_\_\_ - PÓ  
\_\_\_\_\_ - COSTAS

\_\_\_\_\_ - NOTURNO  
\_\_\_\_\_ - FIO  
\_\_\_\_\_ - JÓIA  
\_\_\_\_\_ - LIVROS  
\_\_\_\_\_ - CHAVES  
\_\_\_\_\_ - FLORESTAL

LEIA AS PALAVRAS DOS QUADROS  
E FAÇA UM DESENHO SOBRE ELAS.

ÁGUA

RÉGUA

GUARITA

GUARDA - CHUVA

GUARDANAPO

GUARANÁ

ÉGUA

GUARDA

LEIA AS PALAVRAS E ESCREVA-AS  
COMPLETANDO AS EXPRESSÕES.

ÁGUA	GUARDANAPO	GUARDA	GUARANI
GUARANÁ	MANGUEIRA	GUARÁ	GUARITA

\_\_\_\_\_ - CHUVA

TUPI-\_\_\_\_\_

BANHO DE \_\_\_\_\_

APITO DO \_\_\_\_\_

\_\_\_\_\_ DA MANGUEIRA

GARRAFA DE \_\_\_\_\_

\_\_\_\_\_ DE TRÂNSITO

\_\_\_\_\_ DE PAPEL

\_\_\_\_\_ DO GUARDA

LOBO-\_\_\_\_\_

RECORTE AS FICHAS DAS PALAVRAS E  
COLE-AS DE ACORDO COM OS DESENHOS.

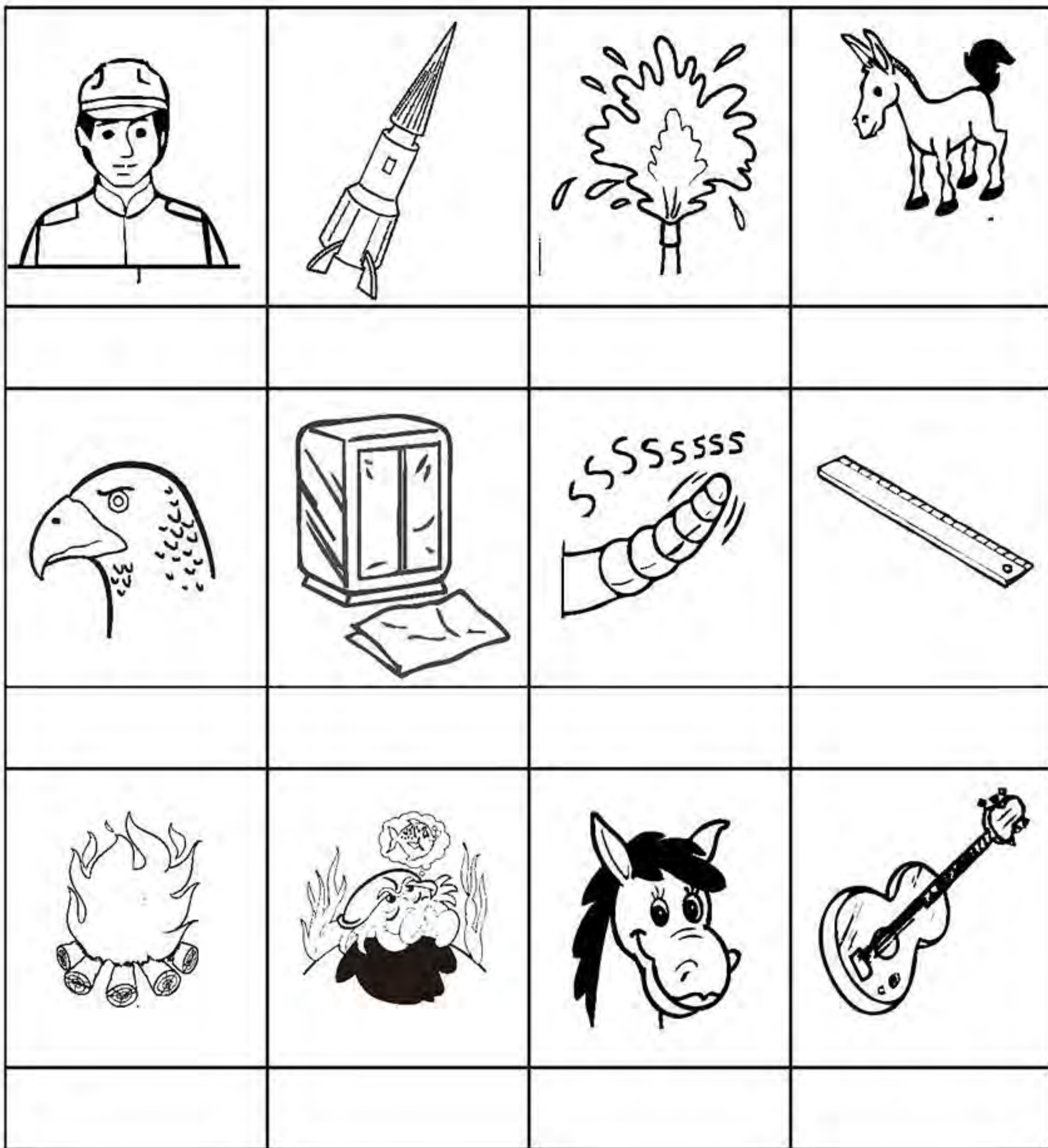

GUIZO	ÁGUIA	CARANGUEJO	FOGUETE
GUARDA	FOGUEIRA	ÉGUA	GITARRA
ÁGUA	GUARDANAPO	RÉGUA	JEGUE

LIGUE O DESENHO QUE CORRESPONDE A ESCRITA.

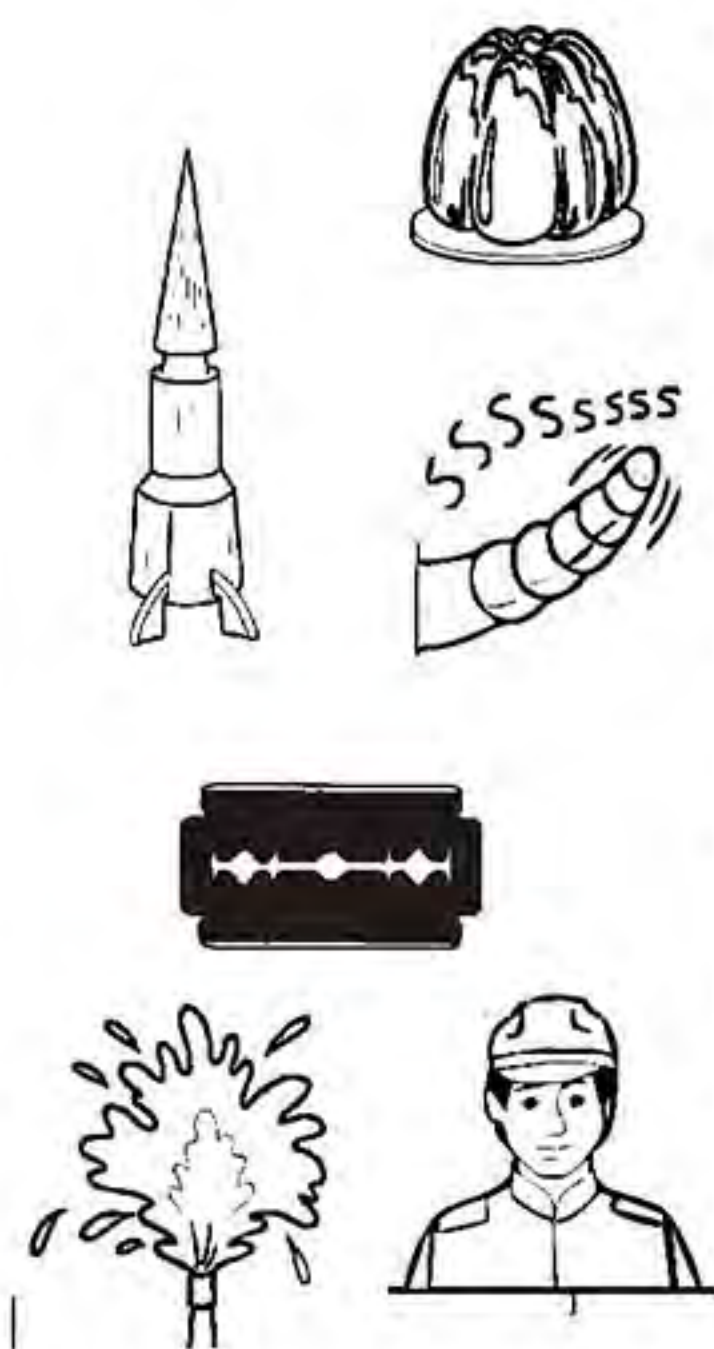

FOGUETE
ÉGUA
AGULHA
QUEIJO
GELATINA
FOGUEIRA
ÁGUA
GUIZO
QUIABO
GILETE
LÍNGUA
GUARDA

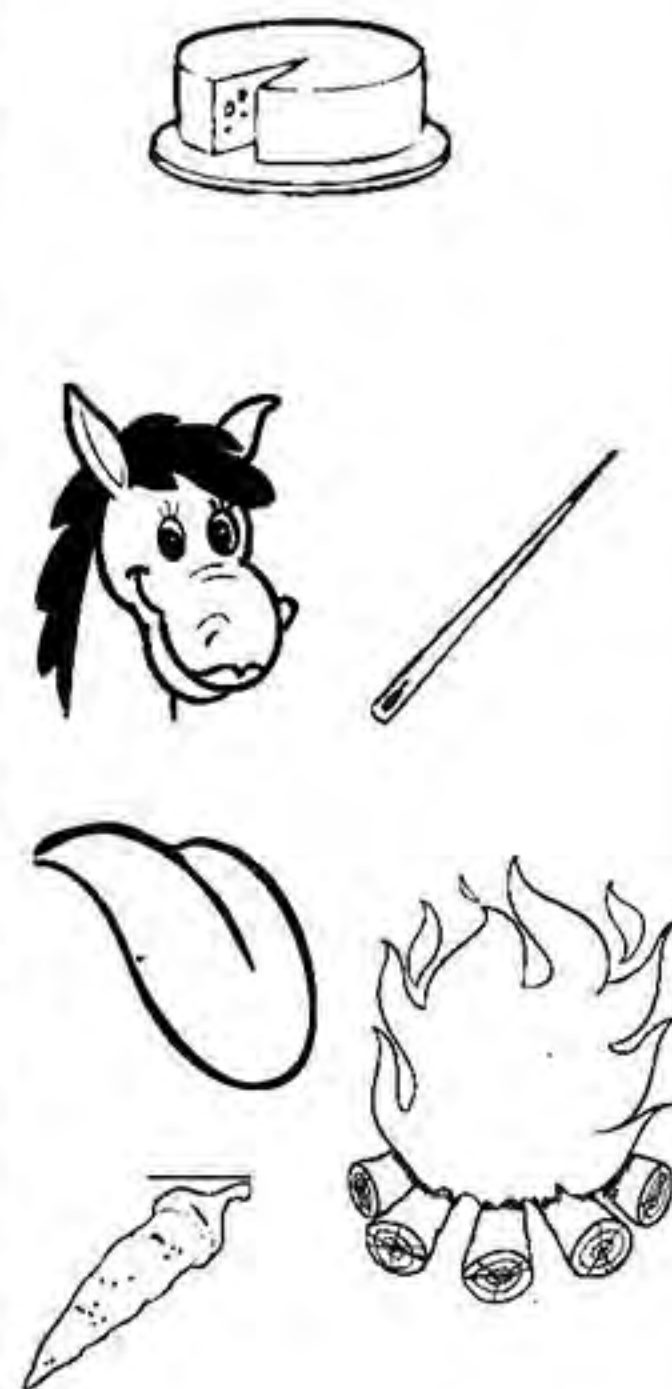

COMPLETE AS PALAVRAS  
COM A SÍLABA ADEQUADA.

GE - GI - GUE - GUI - CE - CI - QUE - QUI

\_\_\_LATINA

SAN\_\_\_

\_\_\_BOLINHA

\_\_\_RIDA

\_\_\_RAFA

\_\_\_TARRA

\_\_\_DADE

A\_\_\_LO

\_\_\_NEMA

\_\_\_TUTE

TI\_\_\_LA

AÇOU\_\_\_

FO\_\_\_TE

CARAN\_\_\_JO

COLE\_\_\_NHA

CAÇA-PALAVRAS.

K	L	I	N	G	Ü	I	Ç	A	Z
W	Z	Q	G	U	A	R	A	N	I
X	P	K	U	I	L	S	V	P	É
Á	G	U	A	A	Í	T	X	I	G
G	U	A	R	A	N	Á	W	N	U
U	R	S	D	P	G	G	K	G	A
A	V	X	A	Q	U	U	R	Ü	C
R	Z	W	S	Y	A	I	T	I	W
D	Y	K	O	T	Q	A	Z	M	X
A	L	M	L	P	S	A	G	Ü	I

ÁGUA  
 LÍNGUA  
 LINGÜIÇA  
 GUARDA  
 ÉGUA  
 GUIA  
 ÁGUIA  
 SAGÜI  
 GUARANÁ  
 GUARANI  
 GUARDA-SOL  
 PINGÜIM

DOMINOX.

GUIZO  
 ÉGUA  
 GUIA  
 LINGÜIÇA  
 SAGÜI  
 PINGÜIM  
 ÁGUA  
 GUARANÁ  
 ÁGUIA

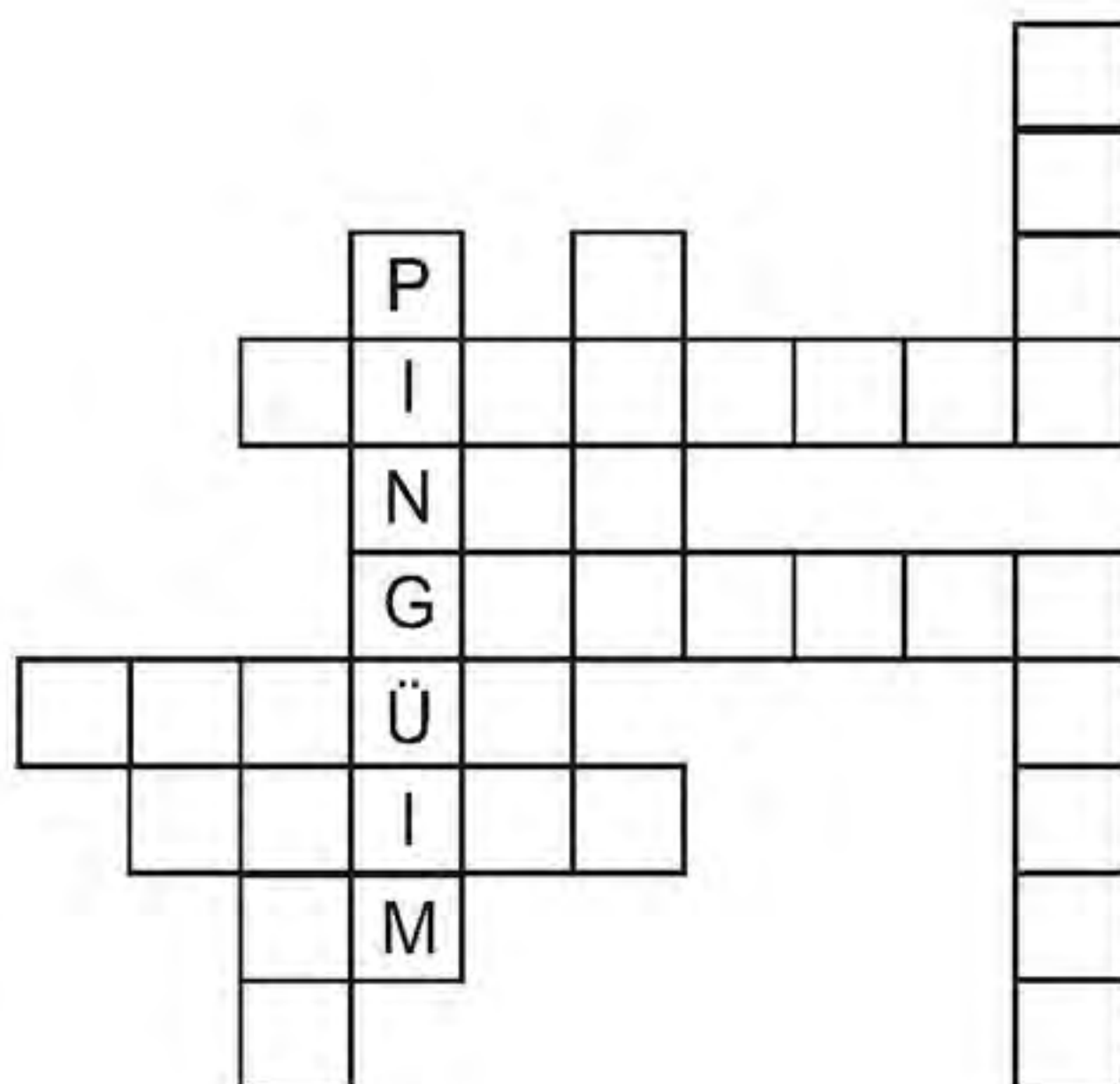

AUTODITADO.

GE - GI

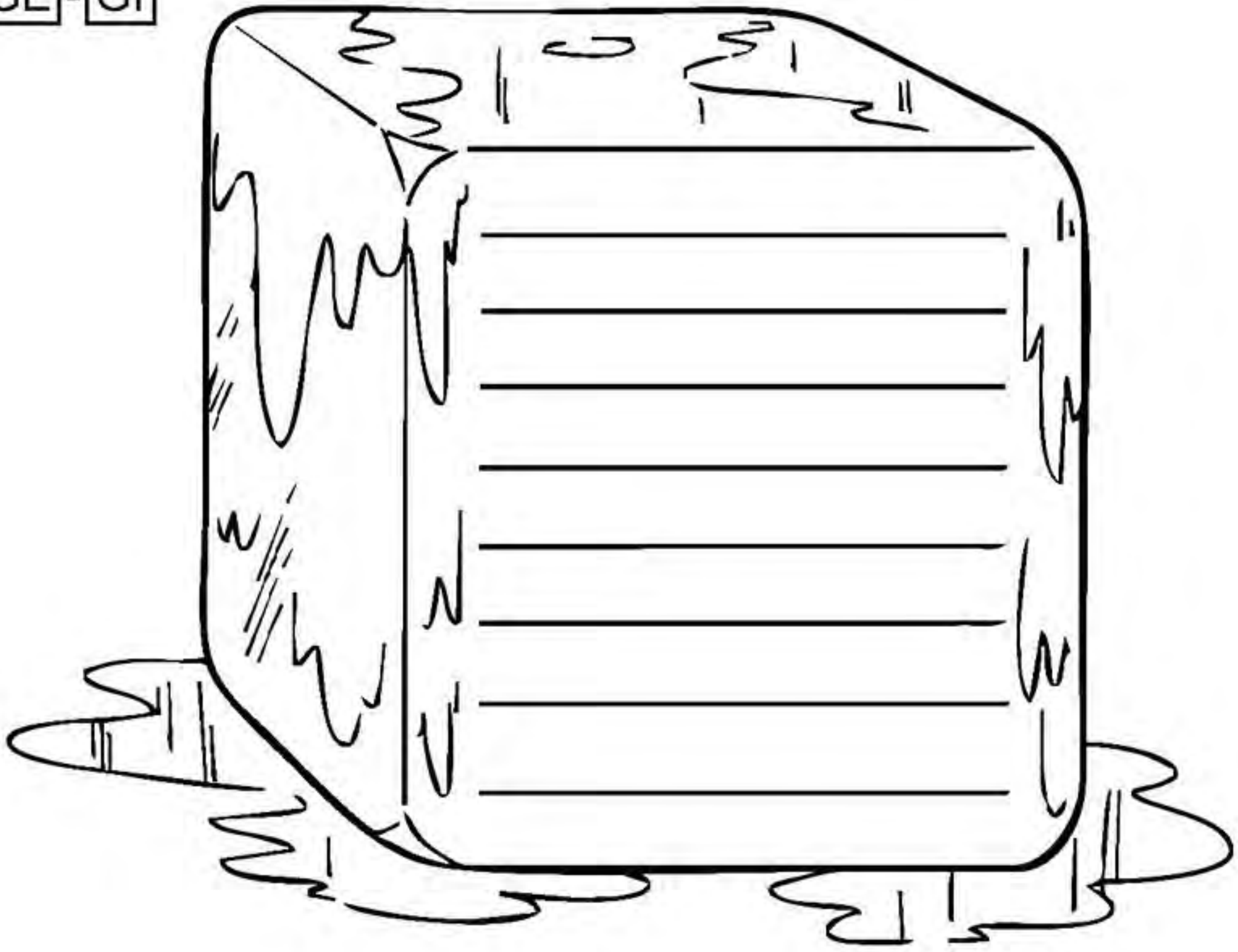

GUE - GUI

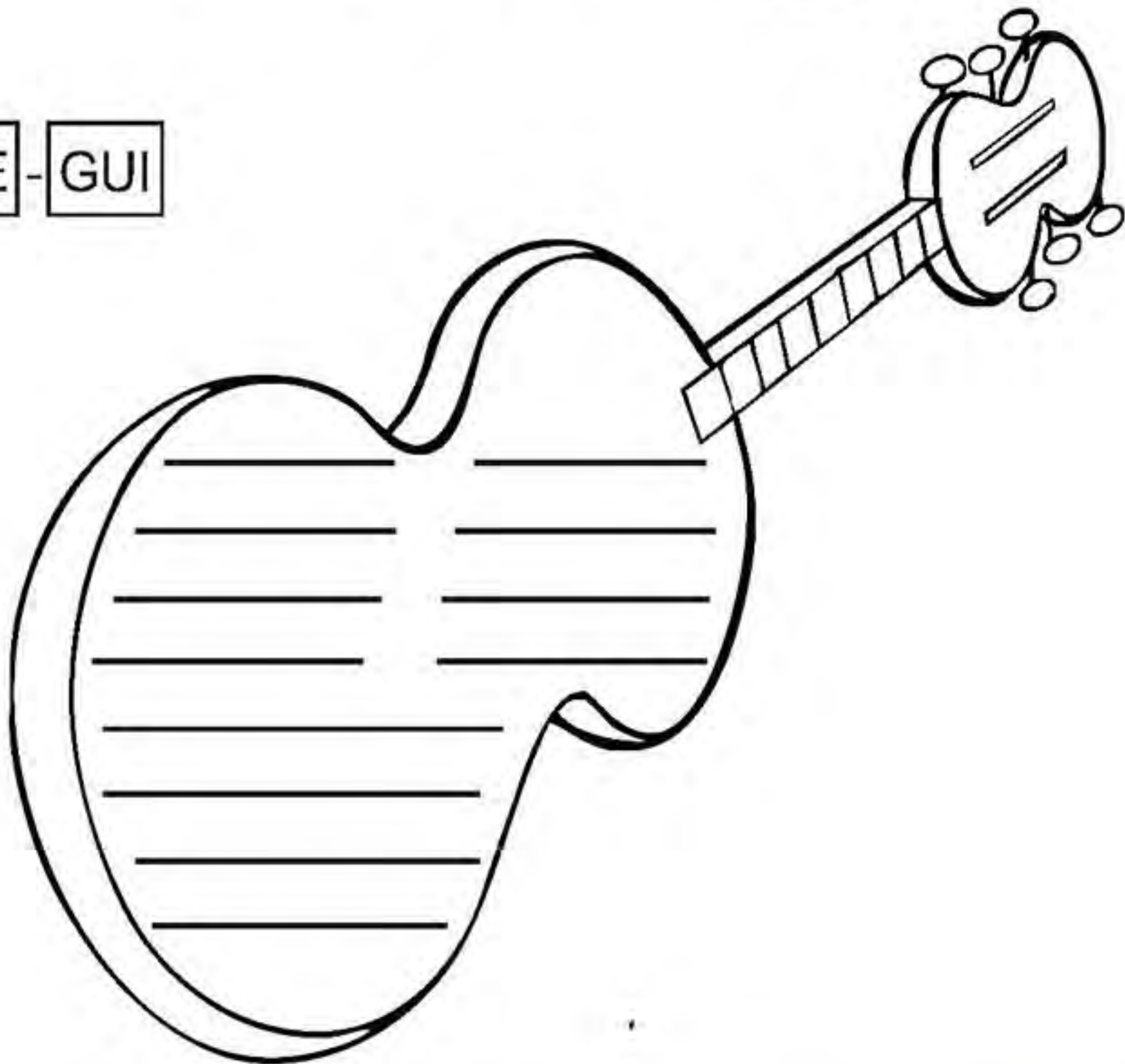



NA BAHIA TEM

NA BAHIA TEM,  
TEM, TEM, TEM!  
NA BAHIA TEM, MORENA  
COCO DE VINTÉM.

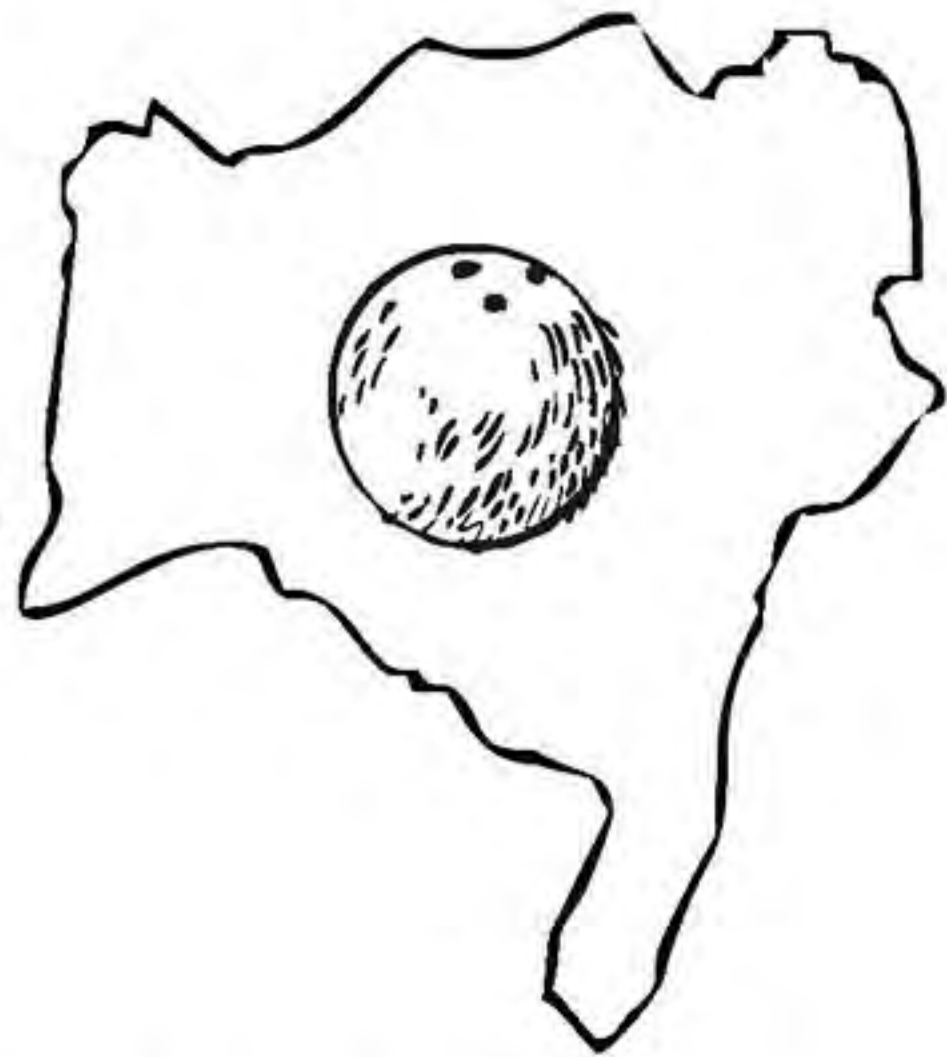

CD CANTIGAS INFANTIS,  
CIRANDA CULTURAL, pág.136

ASSINALE NO TEXTO A PALAVRA **BAHIA**.  
COPIE.

Ha - He - Hi - Ho - Hu

Ha - He - Hi - Ho - Hu

ha - he - hi - ho - hu

ha - he - hi - ho - hu

h

H

h h



H H



homem	hélice	HUGO
HOSPITAL	humano	hotel
HELLMANN'S	hoje	hora
hoje	haver	helicóptero
HELIOS	hiena	hortelã
HÉLIO	há	

LEIA AS PALAVRAS DO QUADRO, CIRCULE AS SÍLABAS COM A LETRA **H** E COPIE AS PALAVRAS, DE ACORDO COM A INDICAÇÃO DAS SÍLABAS.

HAVIA	HIGIENE	HUGO	HOTEL	HÁLITO
HUMANO	HERÓI	HUMOR	HINO	HÁBITO
HELENA	HOJE	HUMANIDADE	HÉLICE	HEPATITE
HISTÓRIA	HOSPITAL	HIENA	HARPA	HORTA

HA	

HE	

HI	

HO	

HU	

COMPLETE AS PALAVRAS COM A LETRA INICIAL ADEQUADA.

___GREJA
----------

___OJE
--------

___LHA
--------

___UMANIDADE
--------------

___UMANO
----------

___ÉLICE
----------

___OSPITAL
------------

___ORA
--------

___UMOR
---------

___EPATITE
------------

___ABILITAÇÃO
---------------

___ORROR
----------

___OMEM
---------

DESCUBRA O SEGREDO E LIGUE AS PALAVRAS.

HÉLICE

UM

HOJE

ARMÁRIO

HINO

HORA

HOMEM

ILHA

HÁBITO

ESTUDO

HUMANO

COPIE AS PALAVRAS QUE VOCÊ  
LIGOU E SEPRE-AS EM SILABAS.





--	--	--

--	--	--

FORME PALAVRAS COM AS SÍLABAS DAS FICHAS.

HIS  
RIA  
TÔ

---

MA  
HU  
NO

---

HO  
O  
RÁ  
RI

---

TI  
PA  
HE  
TE

---

BI  
TO  
HÁ

---

HI  
NA  
E

---

HE  
LI  
CE

RAS  
HA

CIRCULE E COPIE AS PALAVRAS, DE ACORDO COM OS DESENHOS CORRESPONDENTES.

ILHA  
HINO  
HIPOPÓTAMO  
HISTÓRIA



HOMEM  
HORA  
OSTRA  
HOJE



HÉLICE  
ERVILHA  
HELENA  
HERA



IGREJA  
HIPOPÓTAMO  
HINÁRIO  
HIENA



HORA  
HOJE  
HORÁRIO  
HOSPITAL

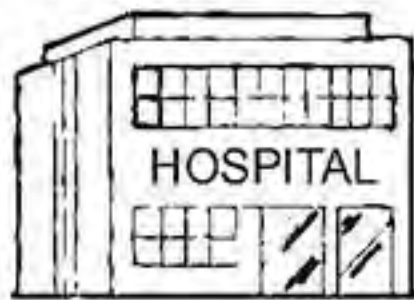

HIGIENE  
HIENA  
HINO  
HISTÓRIA



LIGUE AS SÍLABAS FORMANDO PALAVRAS.

HA — BI — TA — \_\_\_\_\_  
 — LI — TO — \_\_\_\_\_  
 — RAS — \_\_\_\_\_

HE — LI — CE — \_\_\_\_\_  
 — RA — \_\_\_\_\_  
 — XA — \_\_\_\_\_

— NO — \_\_\_\_\_  
 HI — E — NA — \_\_\_\_\_  
 — GI — E — NE — \_\_\_\_\_

HO — JE — \_\_\_\_\_  
 — MEM — \_\_\_\_\_  
 RA — TEL — \_\_\_\_\_

HU — GO — \_\_\_\_\_  
 — MO — \_\_\_\_\_  
 — MA — NO — \_\_\_\_\_

COMPLETE O TEXTO COM AS PALAVRAS QUE FALTAM.

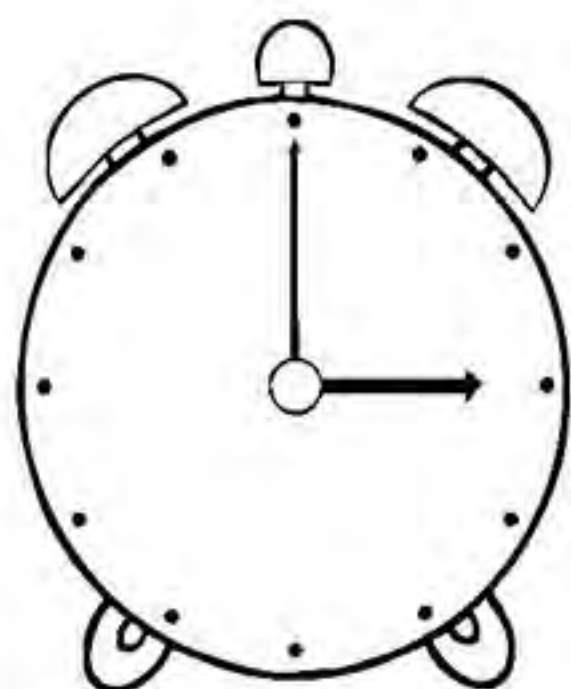

O RELÓGIO MARCA A \_\_\_\_\_.

HÁ \_\_\_\_\_ PARA TUDO.

\_\_\_\_\_ DE ESTUDAR,

\_\_\_\_\_ DE COMER,

\_\_\_\_\_ DE BRINCAR,

\_\_\_\_\_ DE PASSEAR,

\_\_\_\_\_ DE DORMIR.

LEIA AS PALAVRAS E COMPLETE  
A HISTÓRIA SOBRE HELENA E HEITOR.

HOJE	HINO	HEITOR
HELENA	HUMANO	HISTÓRIA

\_\_\_\_\_ E \_\_\_\_\_ TAMBÉM ESTÃO NA MESMA ESCOLA.

NA ENTRADA, TODOS CANTARAM O \_\_\_\_\_ NACIONAL.

\_\_\_\_\_, ELES ESTUDARAM \_\_\_\_\_.

\_\_\_\_\_ E \_\_\_\_\_ ESTÃO ESTUDANDO SOBRE O

CORPO \_\_\_\_\_.

ELES SÃO ÓTIMOS ALUNOS.

NAS PALAVRAS ABAIXO, CIRCULE AS  
SÍLABAS COM A LETRA **H** E DEPOIS COPIE-AS.

HORA

--	--

HOSPITAL

--	--	--

HAVIA

--	--	--

HISTÓRIA

--	--	--

HELENA

--	--	--

HÉLICE

--	--	--

HIENA

--	--	--

HÁLITO

--	--	--

HUMANO

--	--	--

HABILIDADE

--	--	--	--	--

HÉLICE

--	--	--

HIGIENE

--	--	--	--

COPIE AS FRASES SUBSTITUINDO  
OS DESENHOS PELAS PALAVRAS.

VI O  NO JARDIM ZOOLOGICO.

PAPAI VIU A  E FOI PARA O TRABALHO.

NAQUELE MURO HÁ MUITA .

HUGO FAZ A  DOS DENTES.

COMPLETE AS FRASES COM A PALAVRA CORRETA.

HISTÓRIA      HUGO      HINO      HAVIA

HELENA CANTA \_\_\_\_\_ DO HINÁRIO.

HORÁRIO      HAVIA      HINO      HERÓI

HEITOR É O \_\_\_\_\_ DA RUA.

HUMO      HORA      HISTÓRIA      HOJE

COLOQUEI \_\_\_\_\_ NO VASO DE BARRO.

HIENA      HERA      HORA      HIGIENE

A \_\_\_\_\_ SUBIU PELO MURO DA ESCOLA.

JUNTE AS SÍLABAS DOS QUADRADINHOS E FORME PALAVRAS. PARA CADA PALAVRA FORMADA, PINTE-AS EM COR DIFERENTE.

HOR HOS TA HAR HO PI JE TAL PA

HO HI LO HO NO FO TEL TE

FORME PALAVRAS DE ACORDO COM OS NÚMEROS.

1 HO	2 NO	3 HI
4 MEM	5 LO	6 LI
7 HÉ	8 CE	9 TE
10 FO	11 JE	12 RA

1 - 5 - 10 - 9

7 - 6 - 8

1 - 11

1 - 12

1 - 4

3 - 2

LIGUE AS PALAVRAS AOS DESENHOS.

HIENA  
HOTEL  
HIPOPÓTAMO  
HORA  
HELENA  
HARPA  
HÉLICE  
HOMEM  
HINÁRIO  
HOLOFOTE

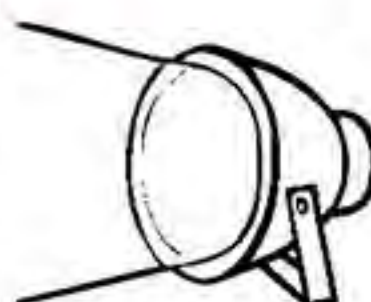
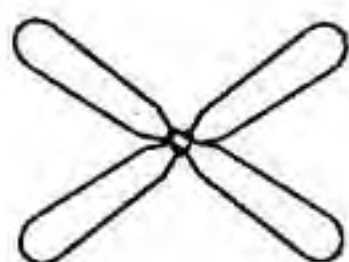
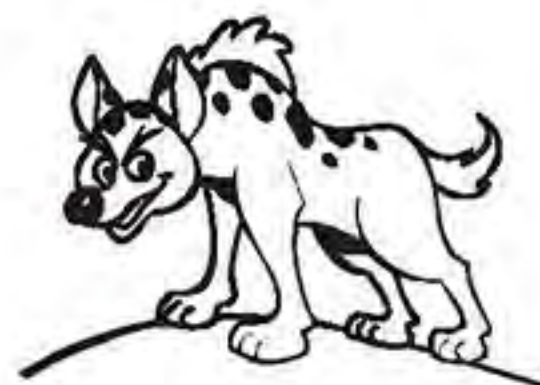

TROQUE A PRIMEIRA LETRA DAS PALAVRAS E ESCREVA OUTRAS PALAVRAS.

HOMEM

\_\_\_\_OMEM  
\_\_\_\_OMEM  
\_\_\_\_OMEM

HORA

\_\_\_\_ORA  
\_\_\_\_ORA  
\_\_\_\_ORA

HINO

\_\_\_\_INO  
\_\_\_\_INO  
\_\_\_\_INO

ESCOLHA UM NOME PARA CADA CRIANÇA.

HEITOR - HILDA - HELENA - HÉLIO - HELOÍSA



CAÇA - PALAVRAS

Z	X	H	Á	B	I	T	O	K	R
W	H	E	M	A	T	O	M	A	H
K	Á	R	F	J	L	N	R	S	O
C	B	A	G	H	U	M	O	X	R
D	H	A	L	T	E	R	E	Z	Á
H	A	M	B	Ú	R	G	U	E	R
A	R	I	P	V	W	K	Q	Y	I
L	A	Q	H	U	R	R	A	L	O
L	S	H	O	L	O	F	O	T	E

HERA	HALL	HÁ	HEMATOMA
HÁBITO	HORÁRIO	HAMBÚRGUER	HUMO
HALTERE	HARAS	HOLOFOTE	HURRA



**AUTODITADO.**

HEITOR ESTÁ PENSANDO EM PALAVRAS QUE TÊM A LETRA **H**.  
VAMOS AJUDÁ-LO A ESCREVÊ-LAS?

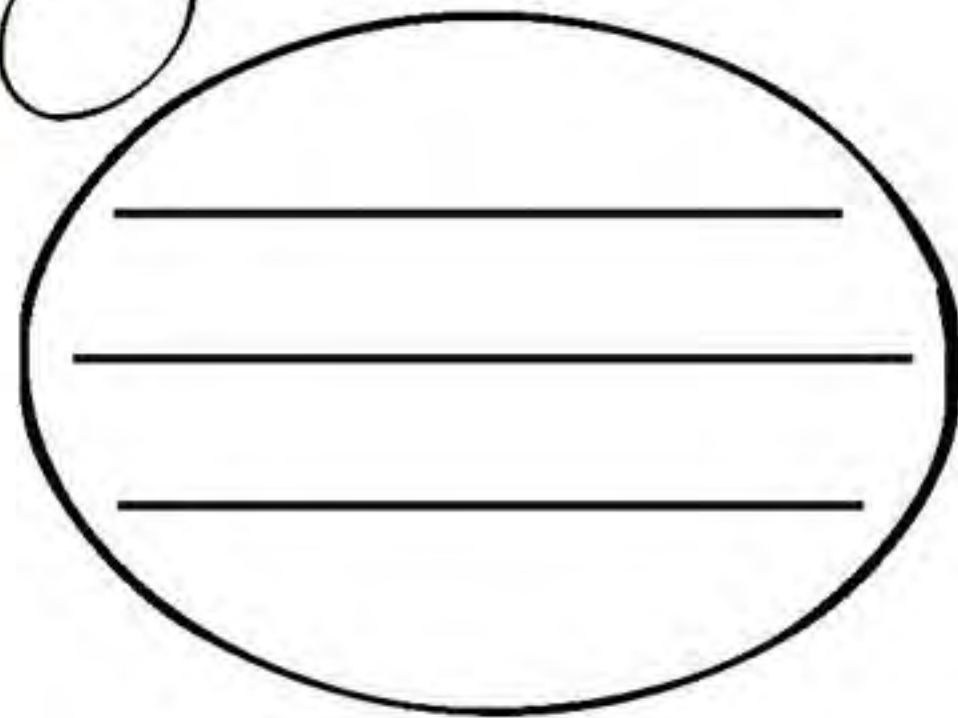
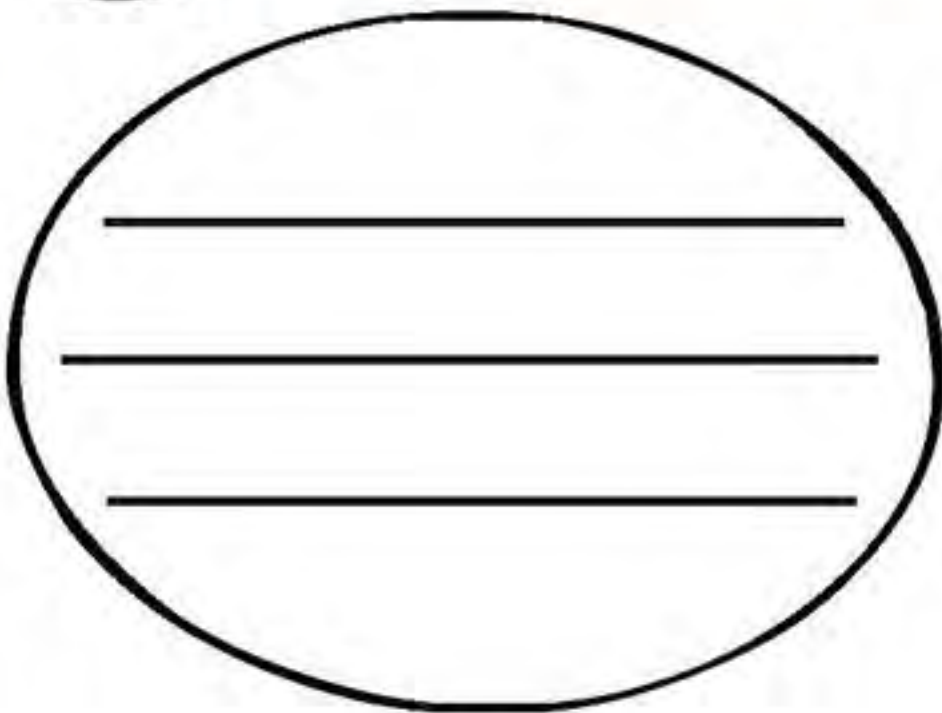
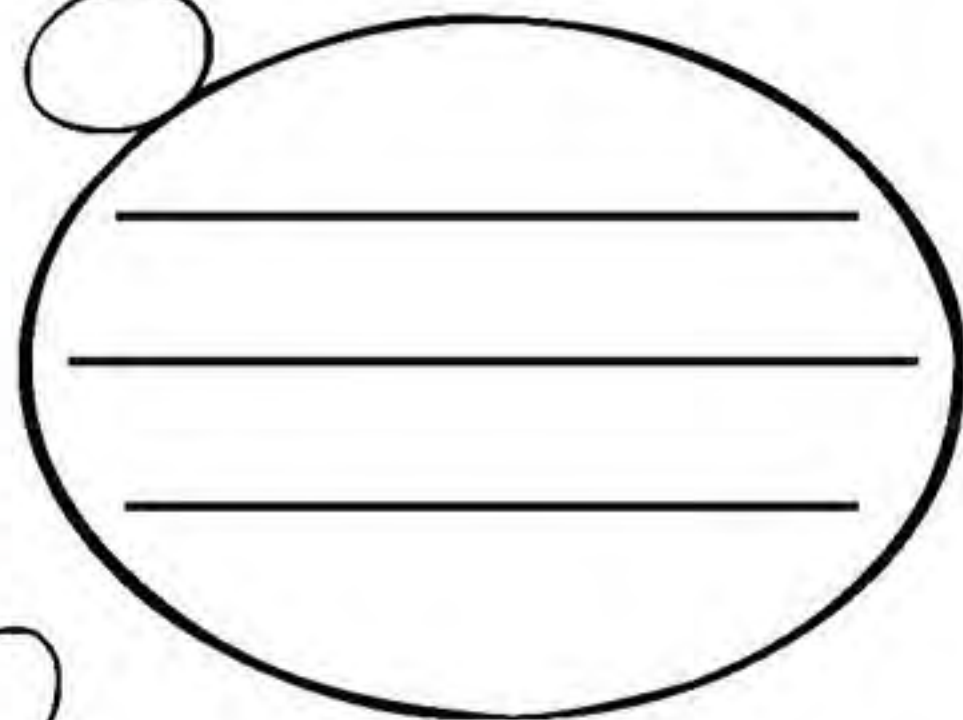
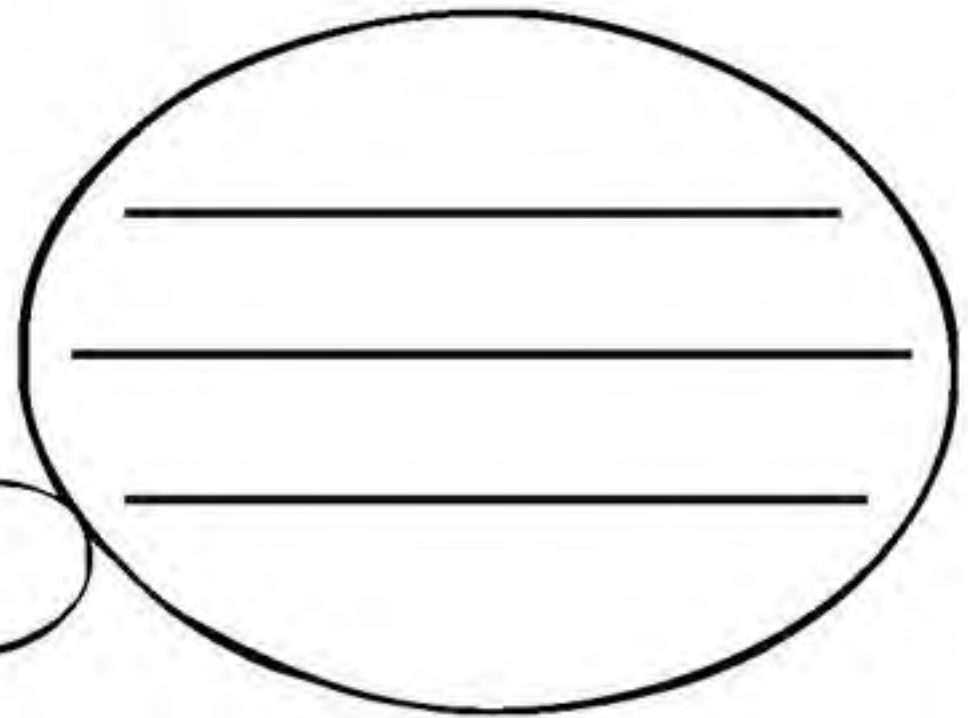
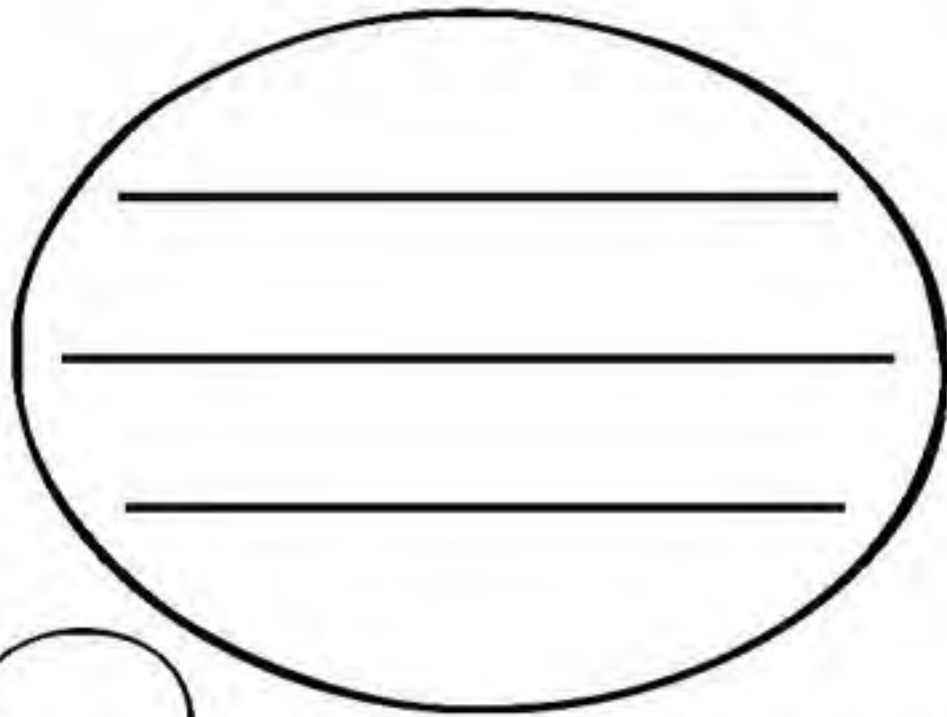

É HORA DO DITADO.

PALAVRAS COM  
A LETRA

H

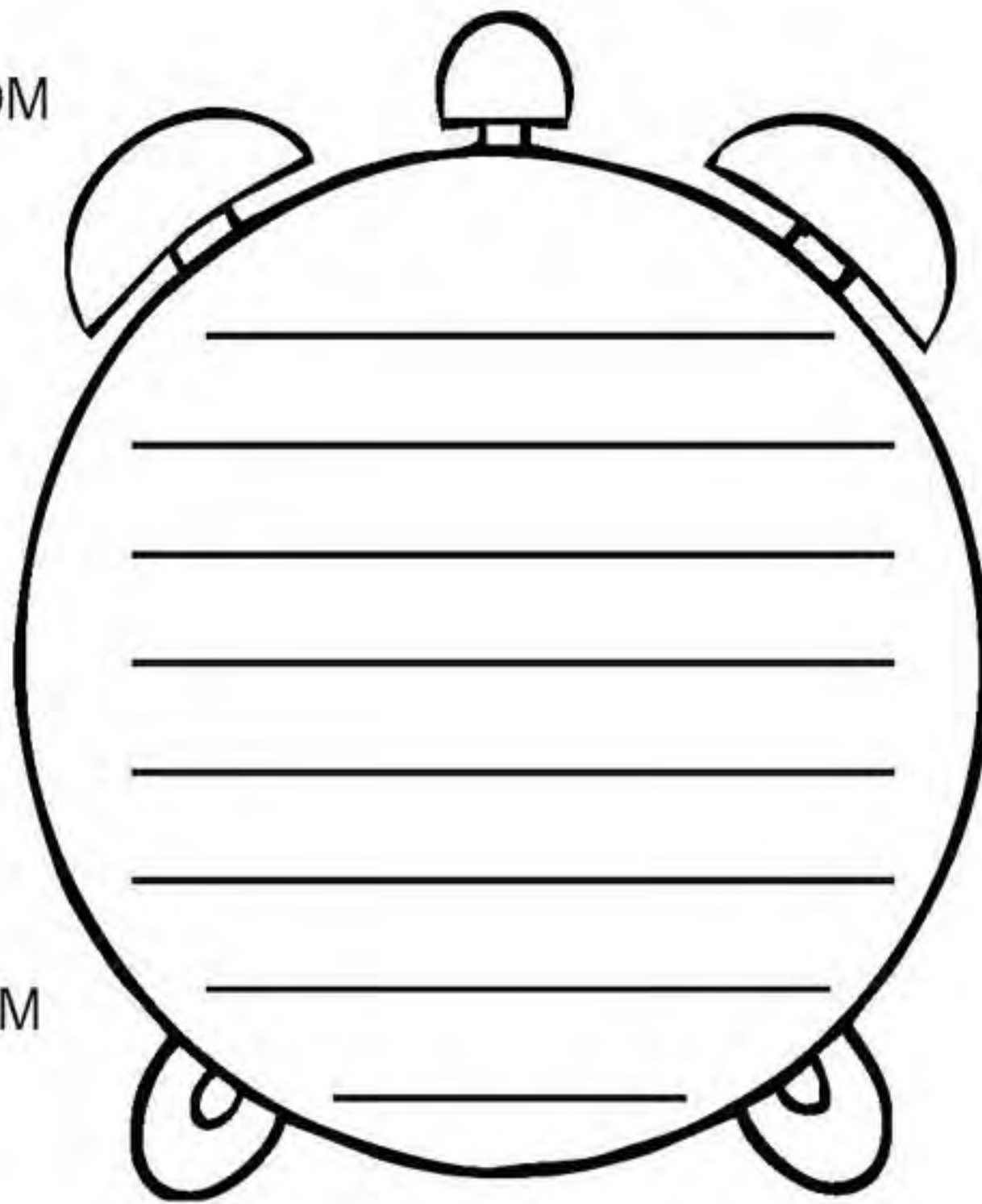

PALAVRAS COM  
A LETRA

A

<hr/> <hr/>	<hr/> <hr/>
<hr/> <hr/>	<hr/> <hr/>
<hr/> <hr/>	<hr/> <hr/>

## O MEU CHAPÉU

O MEU CHAPÉU TEM TRÊS PONTAS,  
TEM TRÊS PONTAS, O MEU CHAPÉU.  
SE NÃO TIVESSE TRÊS PONTAS,  
NÃO SERIA O MEU CHAPÉU.



(CD CANTIGAS INFANTIS,  
CIRANDA CULTURAL, pág. 40.)

ASSINALE NO TEXTO A PALAVRA CHAPÉU.

CHAPÉU

chapéu

chapéu

cha-che-chi-cho-chu

Cha-Che-Chi-Cho-Chu

ch-

Ch-

chave  
chão

CHEQUE

chuveiro

CHINA

chupeta

chove **CHICO**

chocolate

MOCHILA

chuchu

CHURRASCO

chinelos

ch

CH



SUBSTITUA OS CÓDIGOS PELAS SÍLABAS CORRESPONDENTES E FORME PALAVRAS.

CHA	MA	MO	RO	CO	BO	VA	TE
-----	----	----	----	----	----	----	----

DO	VEI	CHO	CHI	CHU	LA	CHE	QUE
----	-----	-----	-----	-----	----	-----	-----

+

+



+









COMPLETE AS PALAVRAS  
ESCREVENDO SÍLABAS DA FAMÍLIA **CH**.

LAN \_\_\_\_

\_\_\_\_ MINÉ

\_\_\_\_ VA

\_\_\_\_ VEIRO

\_\_\_\_ COLATE

MO \_\_\_\_ LA

CA \_\_\_\_

CHU \_\_\_\_

LAN \_\_\_\_ NETE

\_\_\_\_ VARADA

CO \_\_\_\_ LO

\_\_\_\_ GADA

CA \_\_\_\_ RRO

FE \_\_\_\_ DURA

\_\_\_\_ LEIRA

JUNTE AS SÍLABAS DE ACORDO COM OS NÚMEROS E FORME PALAVRAS.

RA	CHU	LA	DA	CHO	MA	TE	CHA	VE	CO
----	-----	----	----	-----	----	----	-----	----	----

1      2      3      4      5      6      7      8      9      10

5 - 10 - 3 - 7                      5 - 9                      1 - 8 - 4                      2 - 7

\_\_\_\_\_

8 - 9                      6 - 8 - 4 - 4                      8 - 6                      1 - 5

\_\_\_\_\_

8 - 1 - 4                      6 - 2 - 10                      1 - 8                      2 - 3

\_\_\_\_\_

FORME PALAVRAS COM AS SÍLABAS QUE ESTÃO NO DESENHO.

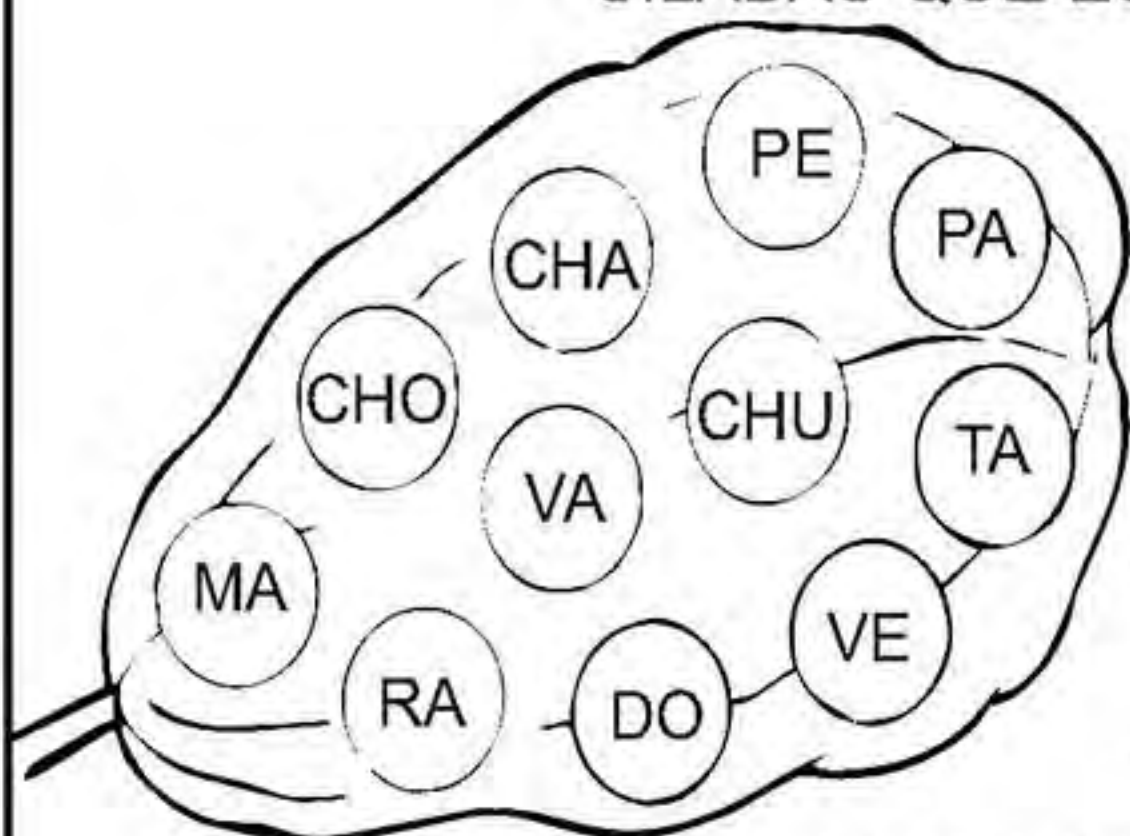

\_\_\_\_\_

\_\_\_\_\_

\_\_\_\_\_

\_\_\_\_\_

ESCREVA PALAVRAS INICIADAS COM AS SÍLABAS INDICADAS ABAIXO.

CHA	CHE	CHI	CHO	CHU

LIGUE AS SÍLABAS FORMANDO PALAVRAS.

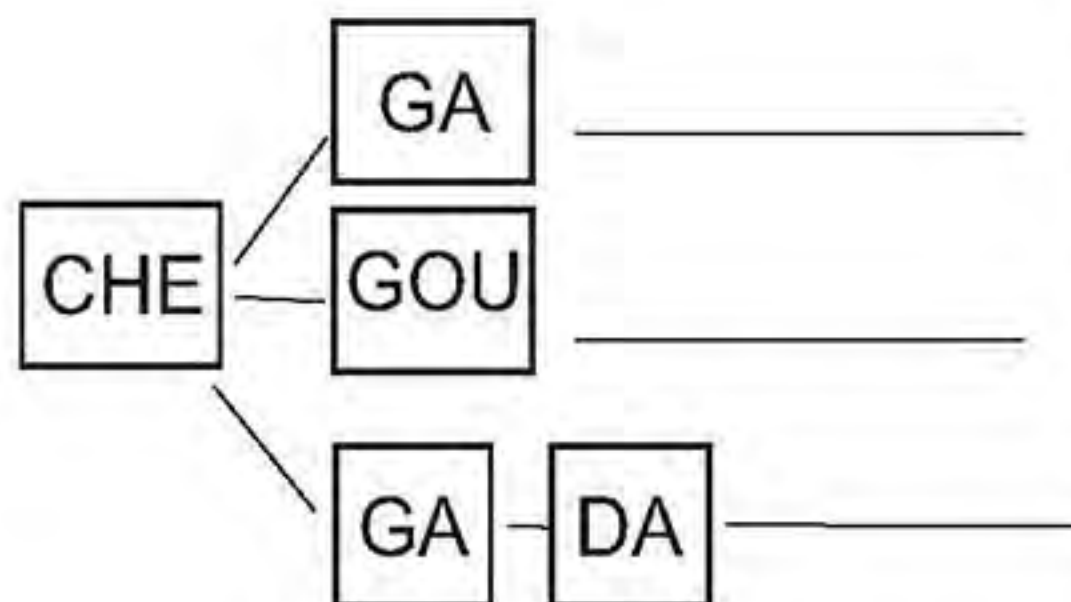
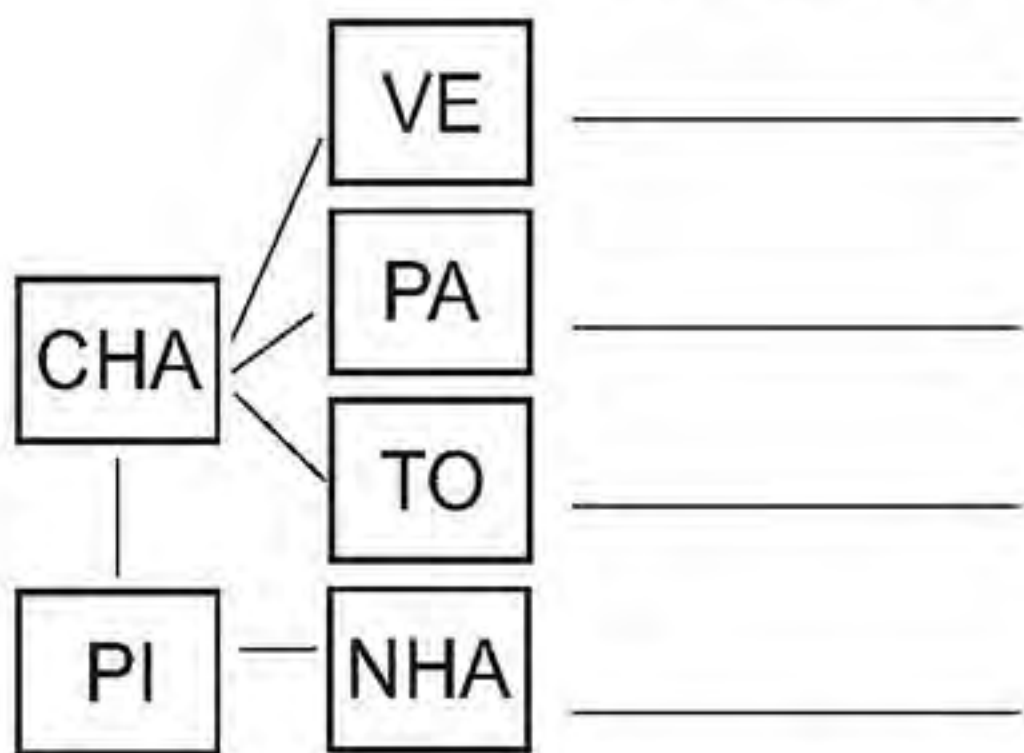

PINTE AS SÍLABAS QUE FORMAM OS NOMES DOS DESENHOS.



CHU NA VA



CHI CI NE LO



XA CHA BE PÉU



BO	MO
CHI	NO
XI	LA



XU	CHU
BE	PE
TA	DA

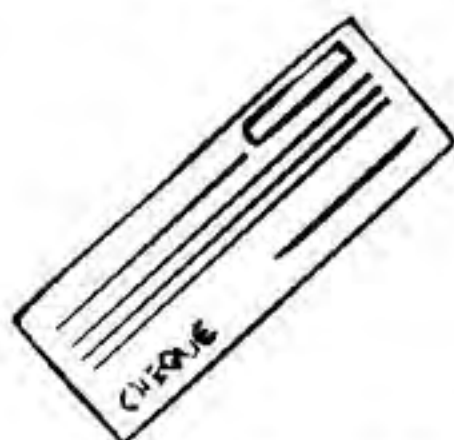

CE CHE TE QUE



CHO CA MOLHO



COL MAO CHÃO

CA	XO
TO	CHOR
RO	NO



CHO	XO
LO	CO
LA	TE



SUBSTITUA OS DESENHOS PELOS  
NOMES E ESCREVA AS FRASES.

A  É DE ALUMÍNIO.

---

TOMEI SOPA DE  E .

---

A  DE CHICO FICOU NA .

---

O BEBÊ DE CHIQUITA CHUPA .

---

COMPLETE AS FRASES COM A PALAVRA CORRETA.

CAMOMILA    CHÁ    CHUCHU    CHOCOLATE

O RECHEIO DO BOLO É DE \_\_\_\_\_.

CHAMINÉ    CHUVEIRO    DUCHA

O \_\_\_\_\_ ESTÁ DESLIGADO DA TOMADA.

CHUTEIRA    CHAPINHA    CHAVE

A \_\_\_\_\_ MACHUCOU O PÉ DO JOGADOR.

CHOROU    CHINELADA    ACHEI

CHIQUINHO FEZ ARTE E LEVOU UMA \_\_\_\_\_.

CIRCULE AS SÍLABAS NAS PALAVRAS ABAIXO, DE ACORDO COM AS SÍLABAS INICIAIS INDICADAS PELOS DESENHOS.

	CHAVE	JANELA	CHAMADA
	XADREZ	CHÁCARA	CANETA
	CHEFE	QUEIJO	CHEIRO
	JEGUE	CHEGA	SEBO
	CHITA	QUILO	MAXIXE
	GIRAFÁ	CHIQUÉ	CHICOTE
	JOGO	CHOCO	CHOQUE
	CACHO	FOGO	SOCO
	CHUCHU	CHUVA	CHUTE
	QUATRO	LUXO	XUXA

LIGUE AS SÍLABAS E FORME PALAVRAS.

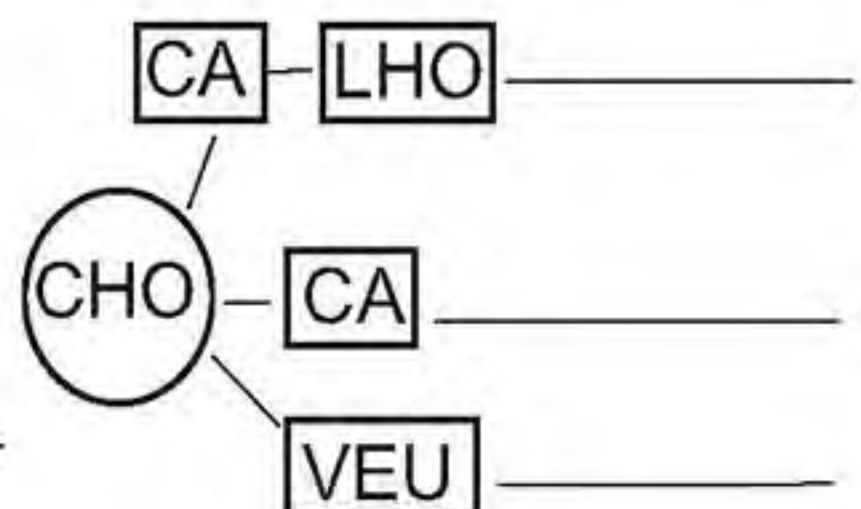
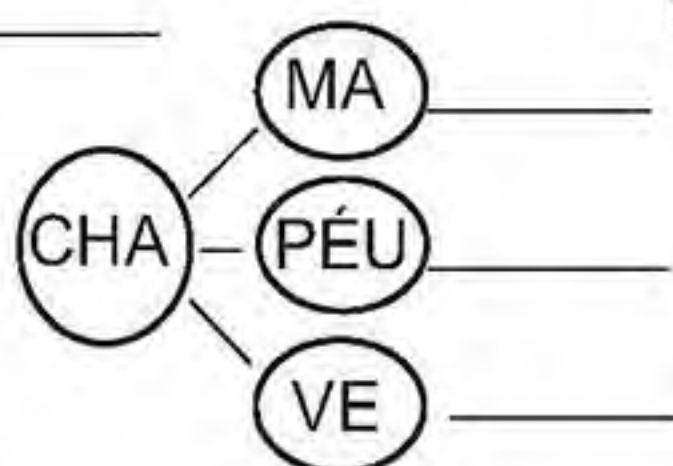
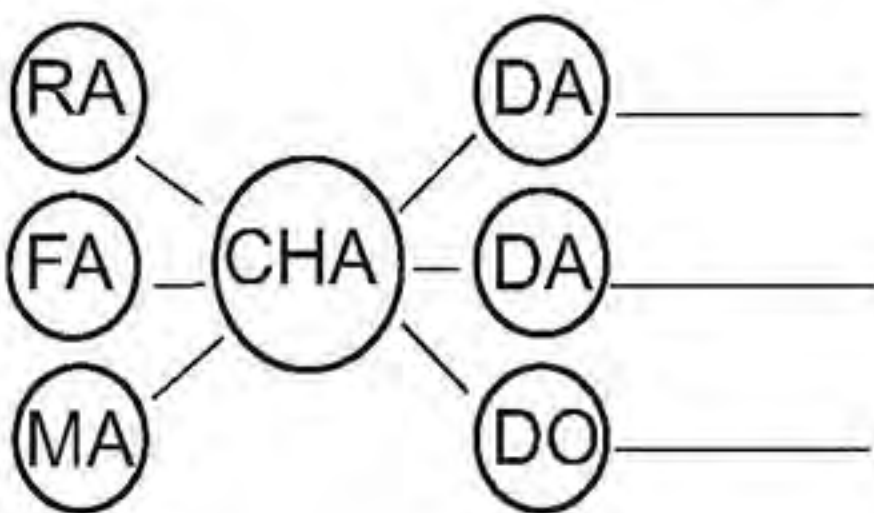



COLOQUE AS PALAVRAS ABAIXO NOS  
RETÂNGULOS, DE ACORDO COM A NUMERAÇÃO.

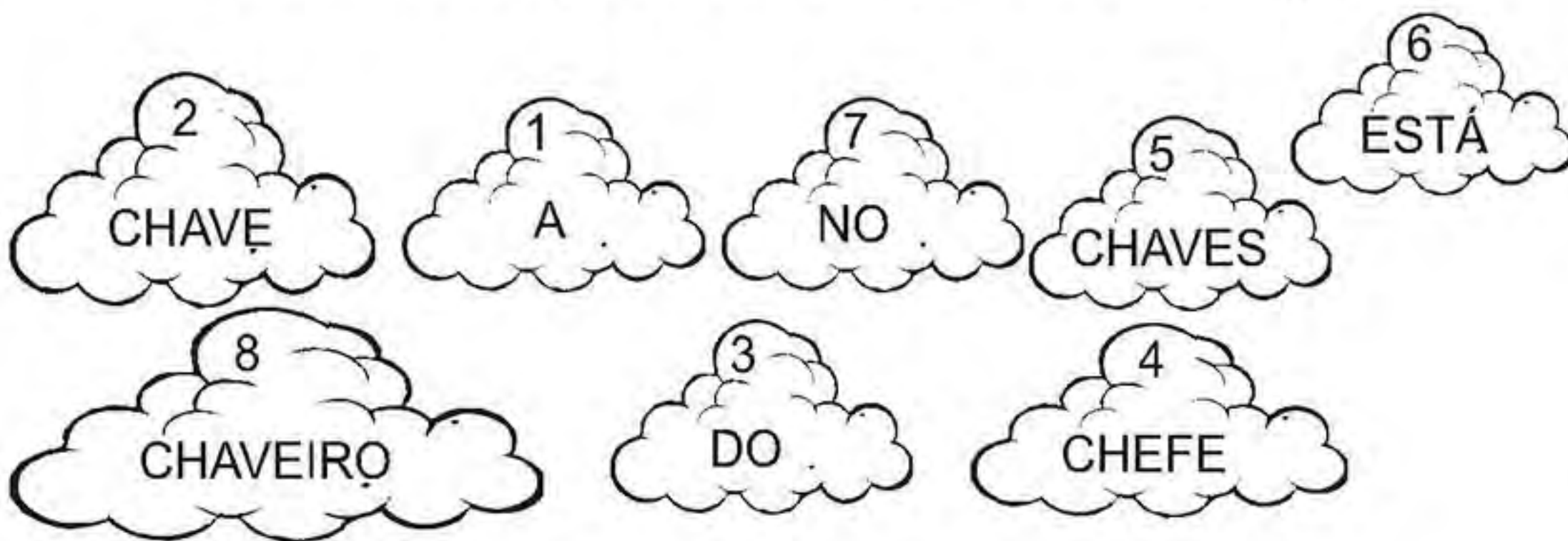

1	2	3	4	5
	6	7	8	

(COLEÇÃO ATIVIDADES DE FOLCLORE, CIRANDA CULTURAL).

COMPLETE O TEXTO COM AS PALAVRAS ABAIXO.

FECHADURA - CHICO - PORTA - CHAVE

\_\_\_\_\_ TEM UMA CHAVE .

ELE COLOCA A \_\_\_\_\_ NA \_\_\_\_\_

E FECHA A \_\_\_\_\_ .

FORME FRASES COM AS PALAVRAS DAS FRASES.

BOLACHA

\_\_\_\_\_

CHAVEIRO

\_\_\_\_\_

CHUPETA

\_\_\_\_\_

CHINELO

\_\_\_\_\_

CHOCOLATE

\_\_\_\_\_

COLOQUE OS SÍMBOLOS, DE ACORDO COM AS SÍLABAS.

CHA ●	CHE ■	CHI ▼	CHO □	CHU ■	CHÃO ☐
----------	----------	----------	----------	----------	-----------

CHINELO	☐	CHAPÉU	☐	CHICOTE	☐
CHAVE	☐	CHOCOLATE	☐	CHUVEIRO	☐
CHUPETA	☐	BOLACHA	☐	CACHORRO	☐
SABICHÃO	☐	SALSICHA	☐	SALSICHÃO	☐

ESCREVA AS PALAVRAS NO QUADRO, DE ACORDO COM O NÚMERO DE SÍLABAS.

CACHO

CACHORRO

FECHADURA

CHAPA

CHEFE

CACHIMBO

CHICOTE

CHUPETA

CHINELO

CHINELADA

CHOCOLATE

CHÁCARA

		▨	▨
▨			
▨			▨
▨	▨		
			▨
▨			
			▨
▨			
			▨

RECORTE AS PALAVRAS DAS FICHAS E  
COLE-AS DE ACORDO COM OS DESENHOS.

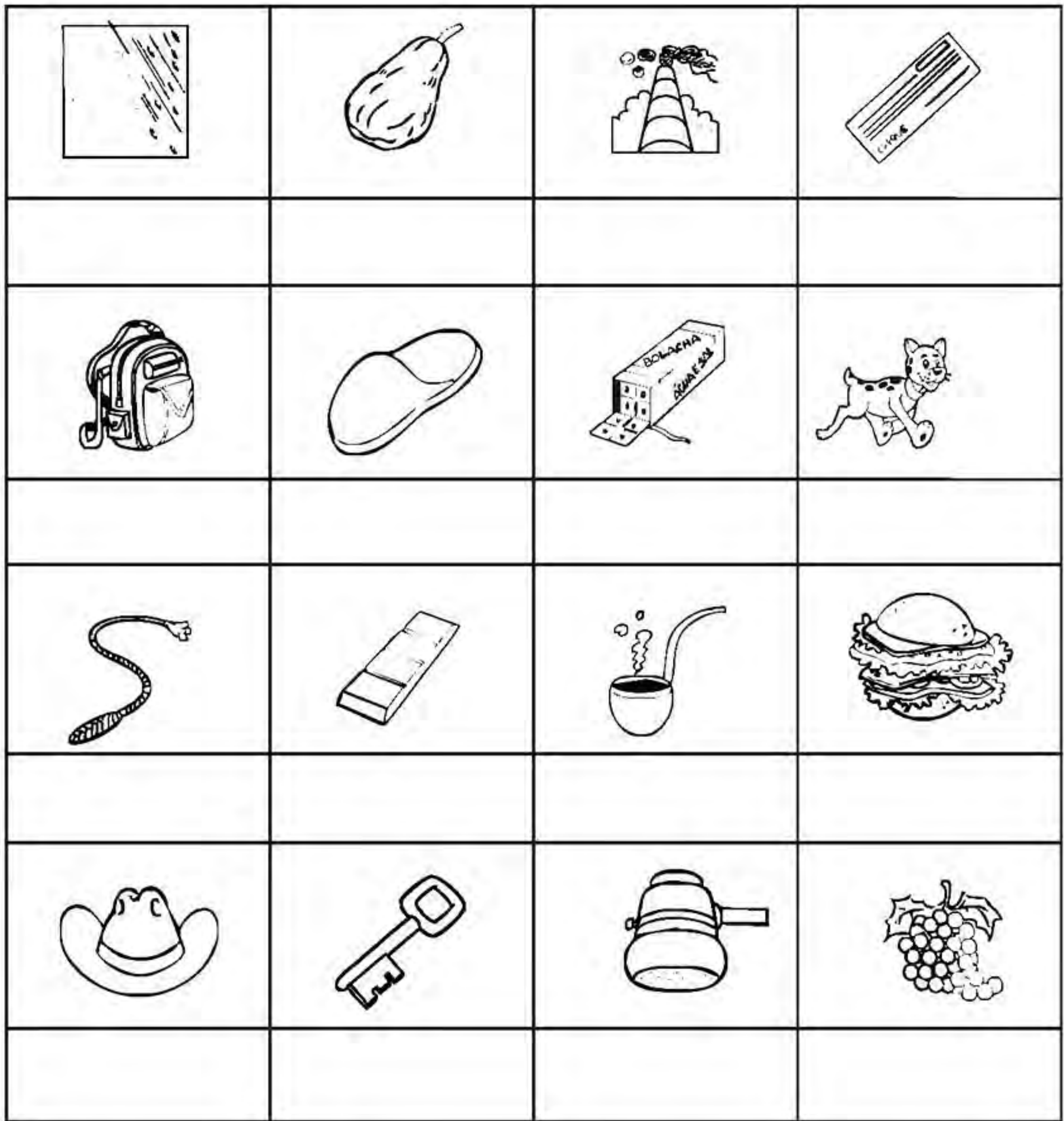

CHAVE	CHUVA	CACHORRO	CHEQUE
BOLACHA	CHINELO	CHAPÉU	CHICOTE
MOCHILA	CHAMINÉ	CHUCHU	LANCHE
CACHO	CHOCOLATE	CACHIMBO	CHUVEIRO

É HORA DO DITADO.

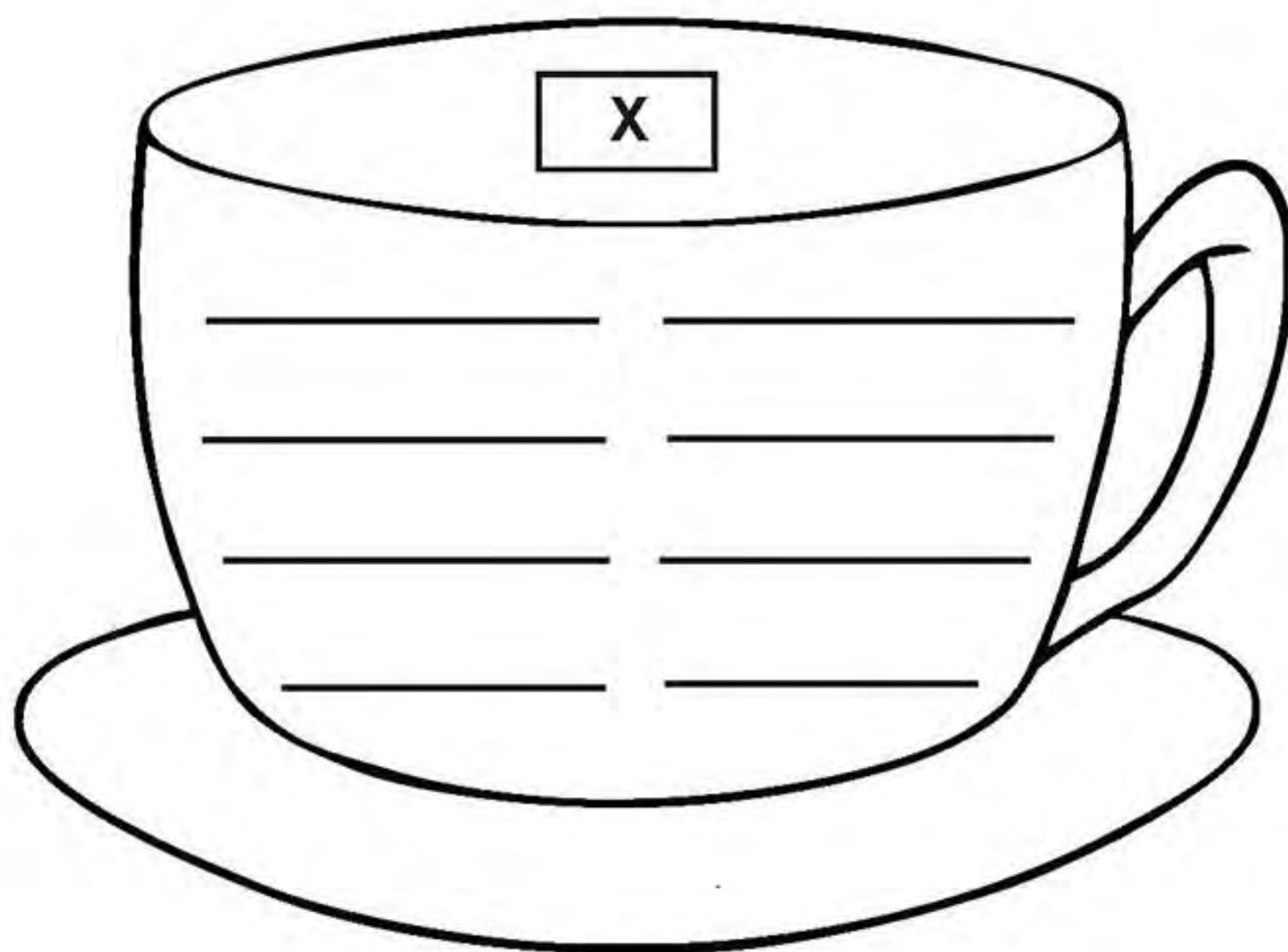
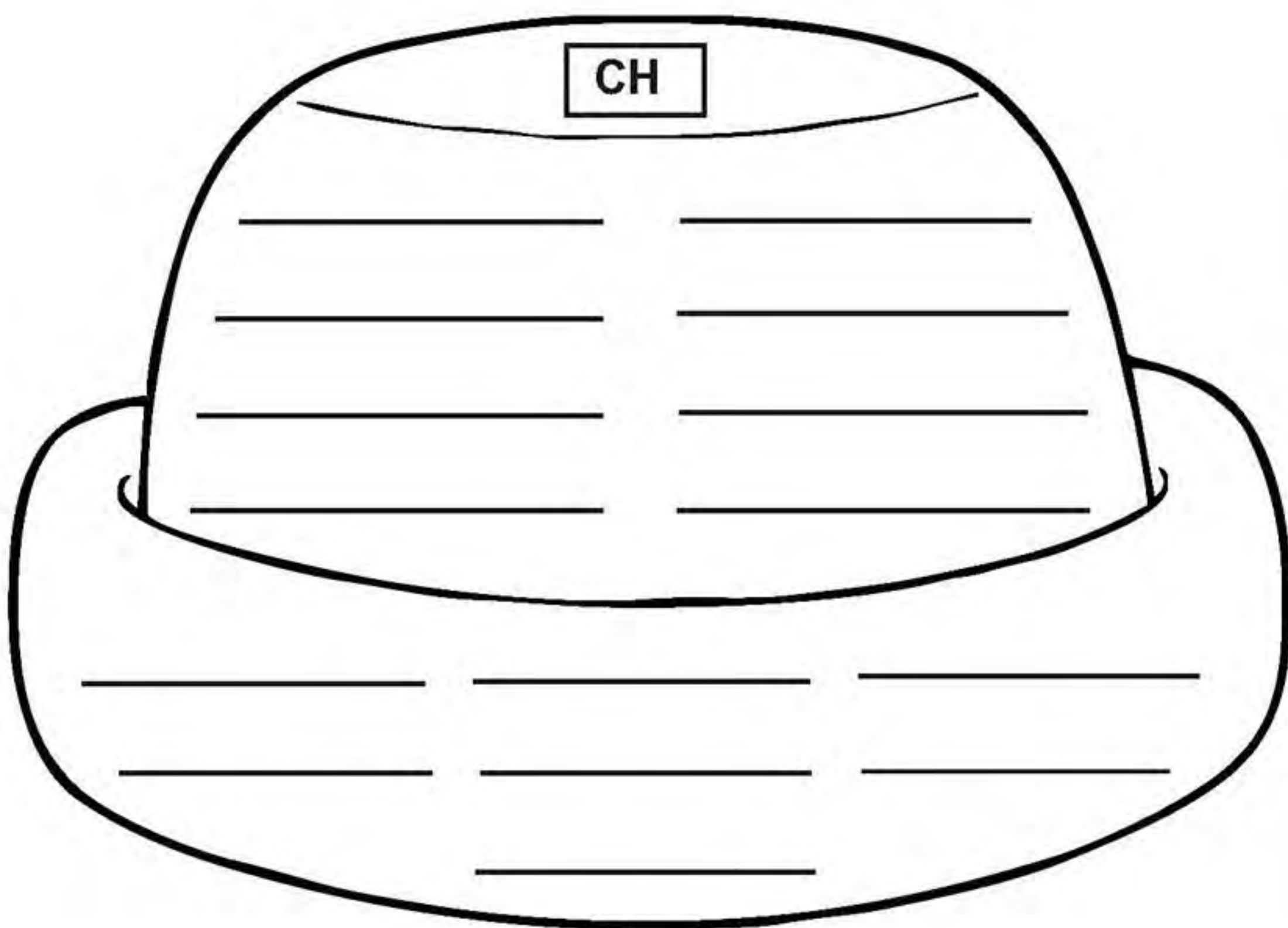

## CANÇÃO DO PALHACINHO

BATE PALMA, PALHACINHO  
BATE PALMA SEM PARAR.  
BATE PALMA, PALHACINHO  
PARA O CIRCO ALEGRAR!

TRÁ – LÁ – LÁ...

PULA, PULA, PALHACINHO  
PULA, PULA SEM PARAR.  
PULA, PULA, PALHACINHO  
PARA O CIRCO ALEGRAR!



(CD CANTIGAS INFANTIS, CIRANDA CULTURAL, pág. 53)

CIRCULE NO TEXTO A PALAVRA **PALHACINHO**.

**PALHACINHO**

lha-lhe-lhi-lho-lhu

Lha-Lhe-Lhi-Lho-Lhu

Iha

Ihã

Lha

Lhã

palhaço    olho  
              filho    espelho  
              ilha     bolha  
agulha    lhama  
              rolha    joelho  
rolha     TELHA  
folha     ALHO    julho

LIGUE OS NOMES AOS DESENHOS E  
DEPOIS SEPARE AS PALAVRAS EM SÍLABAS.

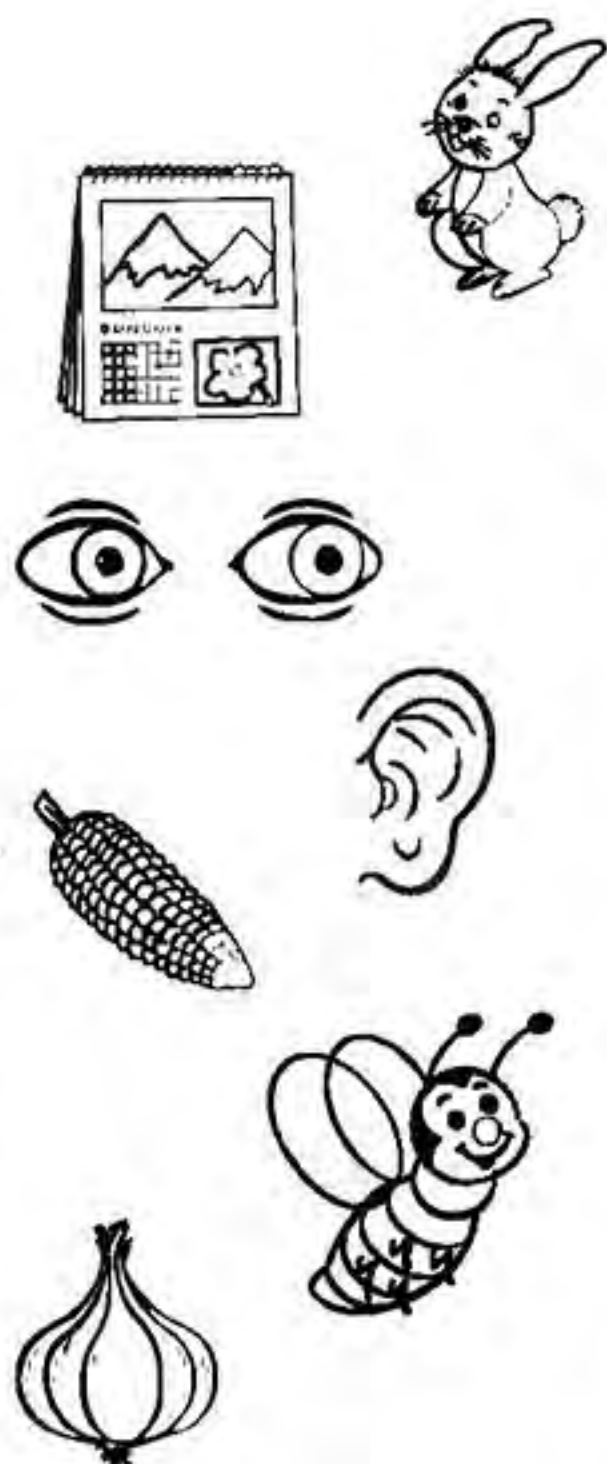

ORELHA

--	--	--

FOLHINHA

--	--	--

MILHO

--	--

COELHO

--	--	--

ALHO

--	--

OLHOS

--	--

ABELHINHA

--	--	--	--

ORDENE AS SÍLABAS E ESCREVA AS PALAVRAS.

LHO - E - CO

--

LHO - GA

BE - LHA - A

--

--

GU - LHA - A

--

GA - NHO - LHI

LHO - A

--

--

LHI - NHA - FO

--

LHA - TE - DO

LHE - BI - TE

--

RE - LHA - O

--

ESCREVA AS PALAVRAS. SIGA O MODELO.

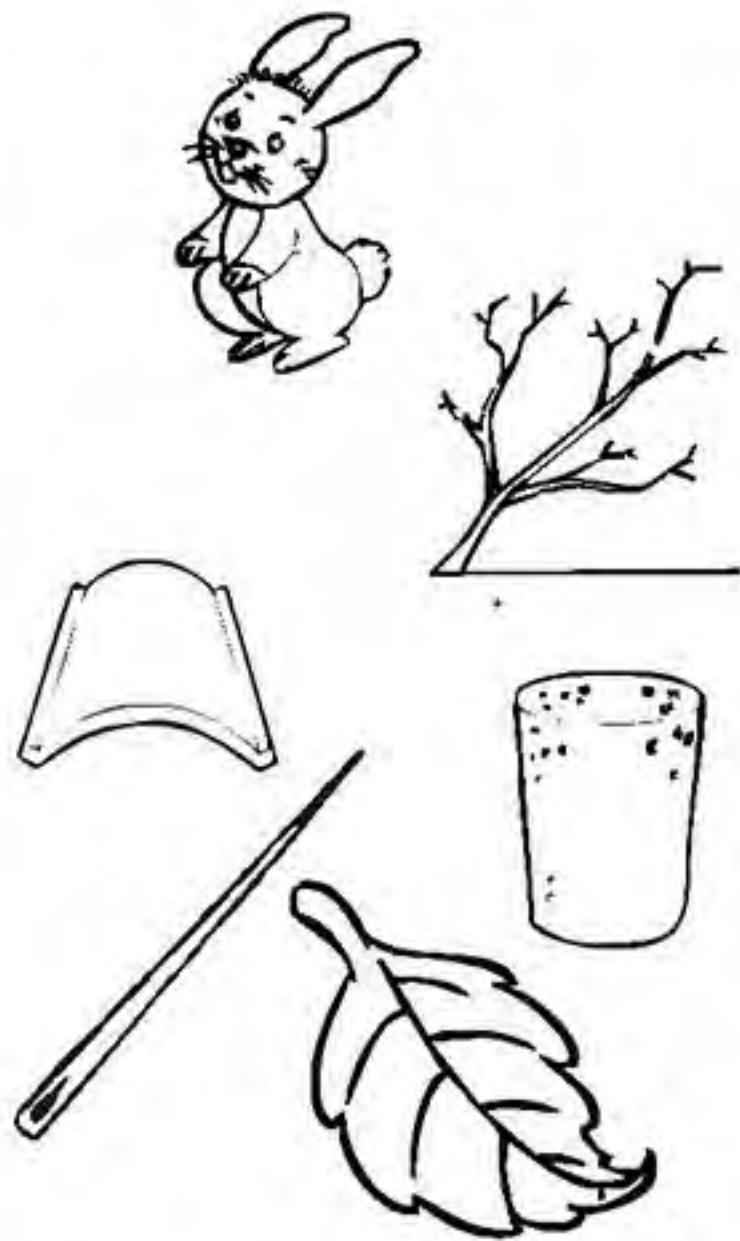

COELHO

COELHINHO

GALHO

\_\_\_\_\_

TELHA

\_\_\_\_\_

ROLHA

\_\_\_\_\_

AGULHA

\_\_\_\_\_

FOLHA

\_\_\_\_\_

LEIA AS PALAVRAS E ESCREVA-AS NOS QUADROS DE ACORDO COM AS SÍLABAS INDICADAS. CIRCULE AS SÍLABAS COM **LH** NAS PALAVRAS.

- ILHA
- ALHO
- BILHETE
- FILHINHO
- OVELHA
- GALHO
- VELHINHO
- ORELHUDO
- MILHO
- RAMALHETE
- JOELHO
- LHAMA
- ABELHUDO

\_\_\_\_\_ **LHA**

\_\_\_\_\_

\_\_\_\_\_

\_\_\_\_\_ **LHE**

\_\_\_\_\_

\_\_\_\_\_

\_\_\_\_\_ **LHI**

\_\_\_\_\_

\_\_\_\_\_

\_\_\_\_\_ **LHO**

\_\_\_\_\_

\_\_\_\_\_



\_\_\_\_\_ **LHU**



\_\_\_\_\_

\_\_\_\_\_

SUBSTITUA OS DESENHOS PELOS NOMES CORRESPONDENTES E ESCREVA AS FRASES.

O  ESTÁ NO PICADEIRO.

O NINHO DO  É DE PALHA DE .

O  É .

VOVÓ GANHOU UM  DE ROSAS.

JUNTE AS SÍLABAS E ESCREVA AS PALAVRAS.

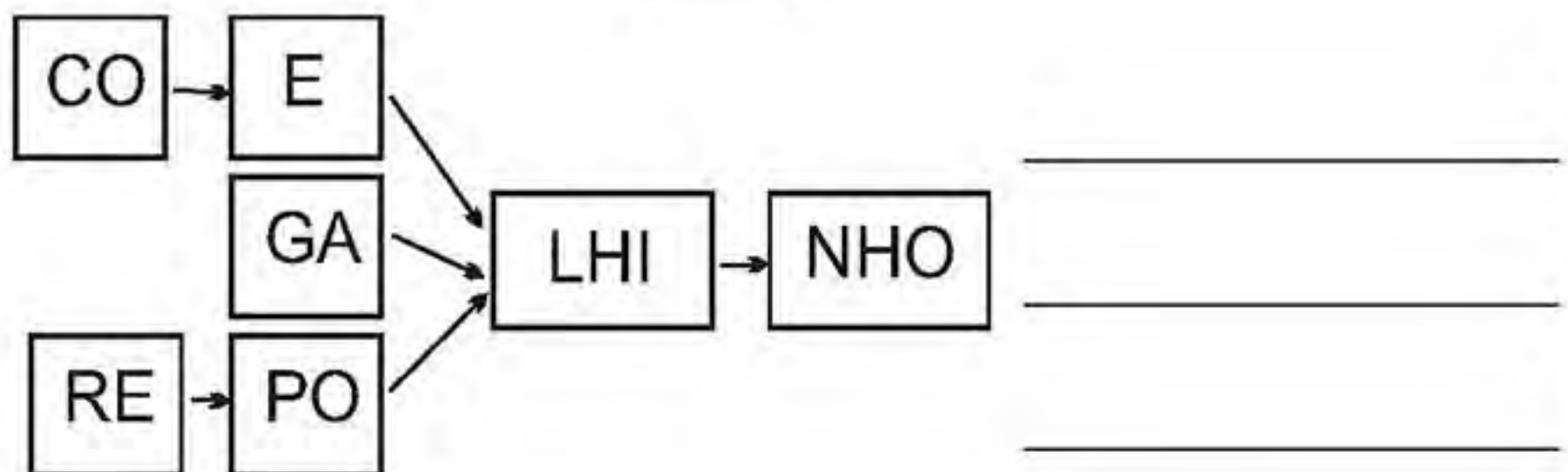
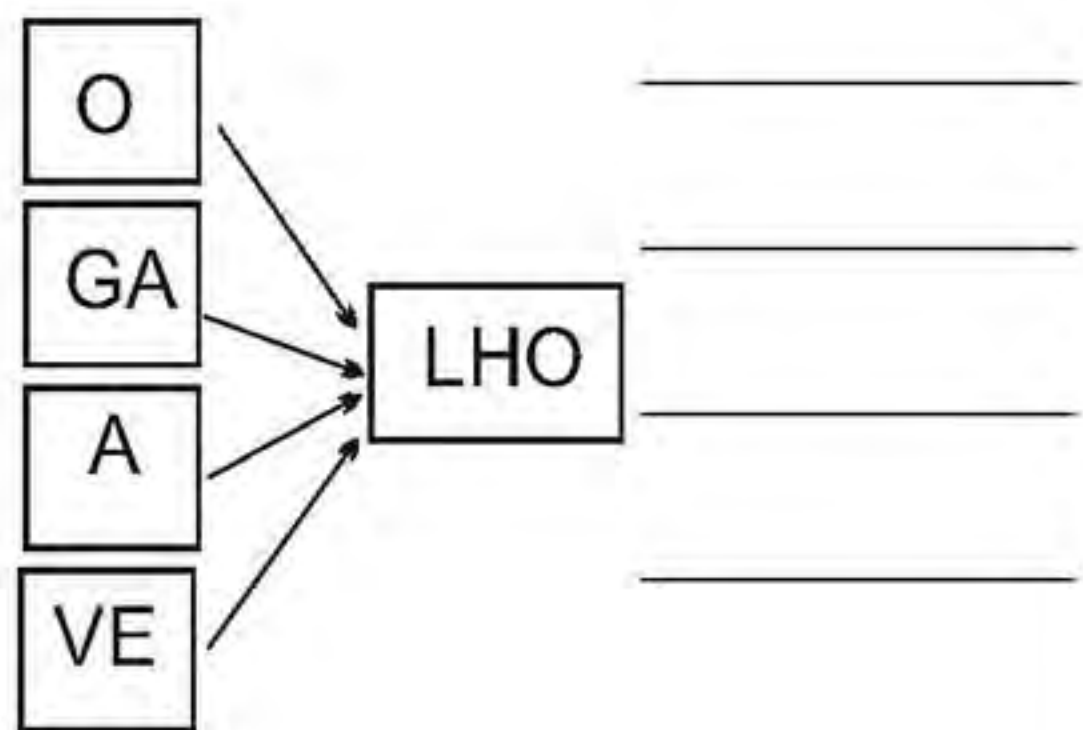
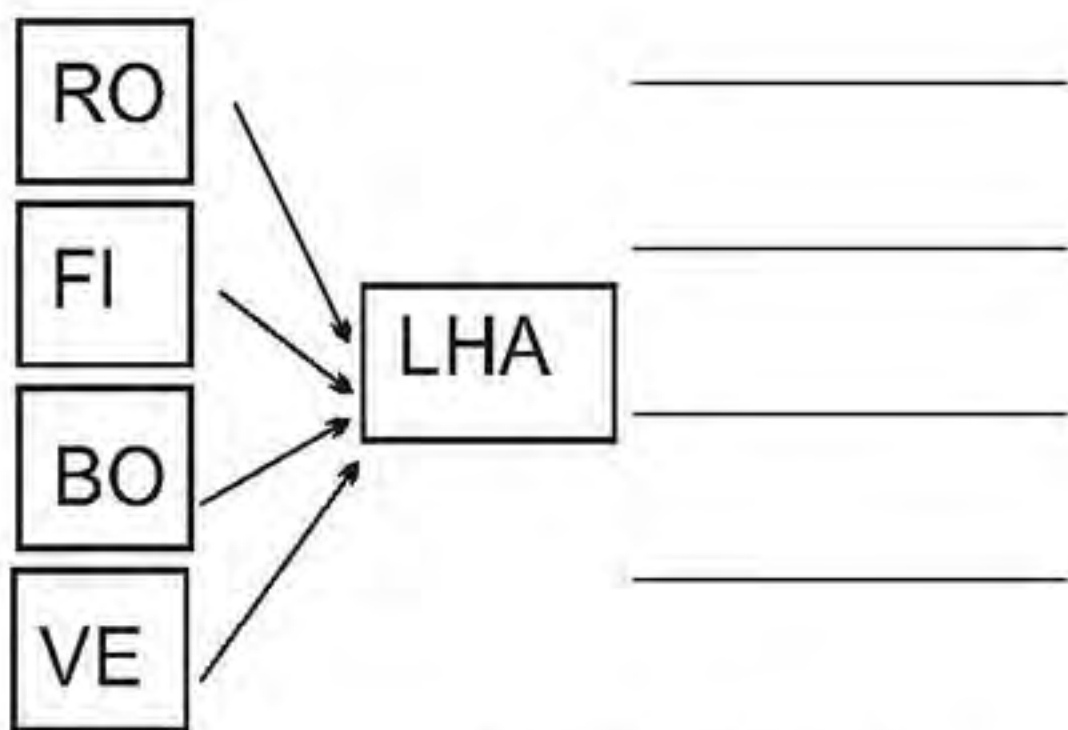

ADIVINHE.  
TEM DENTE, MAS NÃO SE COME; TEM BARBA, MAS NÃO É HOMEM? (ALHO)



LEIA AS PALAVRAS E ESCREVA  
COMPLETANDO AS FRASES.

GARGALHADA - PALHAÇO - VERMELHO - CAMBALHOTA

CAÇULA É O \_\_\_\_\_ DO CIRCO. NO PESCOÇO, ELE  
TEM UM LAÇO \_\_\_\_\_.

CAÇULA DÁ \_\_\_\_\_ E A MENINADA RI DO \_\_\_\_\_.  
A CRIANÇADA SE DIVERTE DANDO MUITA \_\_\_\_\_.

COMPLETE AS PALAVRAS COM  
AS SÍLABAS **LHA**, **LHE** **LHI**, **LHO**, **LHU**.

PA \_\_\_\_\_

CAMBA \_\_\_\_\_ TA

OVE \_\_\_\_\_

GA \_\_\_\_\_

PA \_\_\_\_\_ ÇO

MA \_\_\_\_\_

BI \_\_\_\_\_ TE

VE \_\_\_\_\_ NHA

COE \_\_\_\_\_

A \_\_\_\_\_

ABE \_\_\_\_\_ DO

O \_\_\_\_\_

\_\_\_\_\_ MA

BI \_\_\_\_\_ TINHO

REPO \_\_\_\_\_

FORME PALAVRAS, SUBSTITUINDO OS  
NÚMEROS PELAS SÍLABAS CORRESPONDENTES.

1	2	3
FO	PA	TO
4	5	6
TA	LHE	LHA
7	8	9
RO	A	LHO
10	11	12
BA	CA	RA

1 - 6

2 - 6

4 - 6

2 - 5 - 4

1 - 5 - 3

7 - 6

8 - 4 - 9

10 - 12 - 9

11 - 6

12 - 6

ORDENE AS PALAVRAS E ESCREVA AS FRASES.

PALHETA

DO

É

PALHAÇO.

A

CHEIO

ABELHINHAS

ESTÁ

O

JARDIM

DE

QUEBROU.

O

DA

GALHO

ÁRVORE

NO

ESTÁ

O

ESPANTALHO

MILHARAL.

ESCREVA OS NOMES DOS DESENHOS  
E SEPRE AS PALAVRAS EM SÍLABAS.

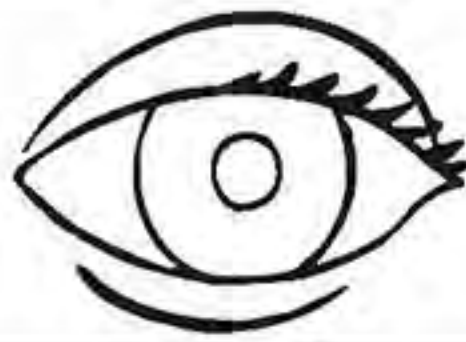
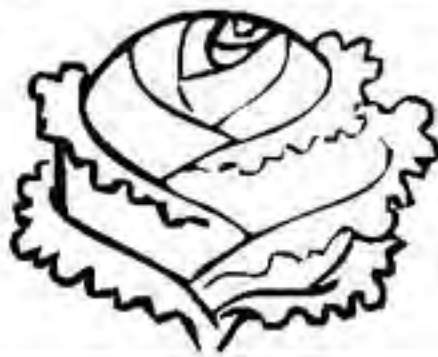
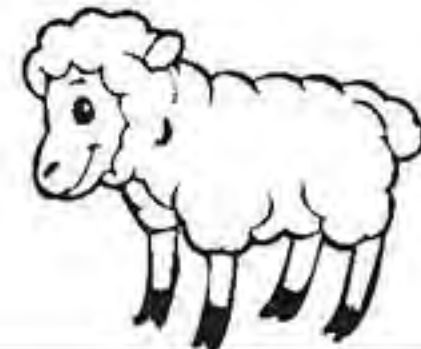
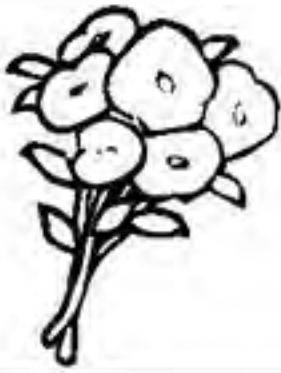

OBSERVE AS PALAVRAS E COPIE-AS NO LUGAR ADEQUADO, DE ACORDO COM AS SÍLABAS EM DESTAQUE.

GALHO VELHINHO ESPELHO AGULHA BARULHINHO	LHA	LHE
	BARULHÃO ORELHA MILHO COELHO ORELHUDO ORELHÃO OVELHA BILHETE	LHI
LHO	LHU	LHÃO

LEIA AS PALAVRAS E ESCREVA-AS, COMPLETANDO AS EXPRESSÕES.

MILHO	BOLHA	JOELHO	VELHINHO
BILHETE	VERMELHO	PALHAÇO	VELINHA
ESPELHO	OVELHA	ORELHÃO	REPOLHO

\_\_\_\_\_ DE SABÃO  
 \_\_\_\_\_ ENGRAÇADO  
 \_\_\_\_\_ FOFINHA  
 HOMEM \_\_\_\_\_  
 GORRO \_\_\_\_\_  
 \_\_\_\_\_ QUEBRADO

ESPIGA DE \_\_\_\_\_  
 \_\_\_\_\_ DE PORCO  
 SALADA DE \_\_\_\_\_  
 \_\_\_\_\_ DO BOLO  
 \_\_\_\_\_ RASGADO  
 \_\_\_\_\_ QUEBRADO

COMPLETE AS FRASES COM AS PALAVRAS ABAIXO.

MALHADA  
ORELHUDO

PALHA  
COELHA

FILHOTINHO  
MILHO

MALHADA É UMA \_\_\_\_\_.

SEU NINHO É DE \_\_\_\_\_ DE \_\_\_\_\_.

ELA TEM UM \_\_\_\_\_.

SEU FILHOTE É BEM \_\_\_\_\_.

O COELHINHO DE \_\_\_\_\_ É LINDO.

ESCREVA AS PALAVRAS QUE ESTÃO  
REPRESENTADAS POR MEIO DOS DESENHOS,  
CUJAS PALAVRAS TÊM SÍLABAS COM **LH**.

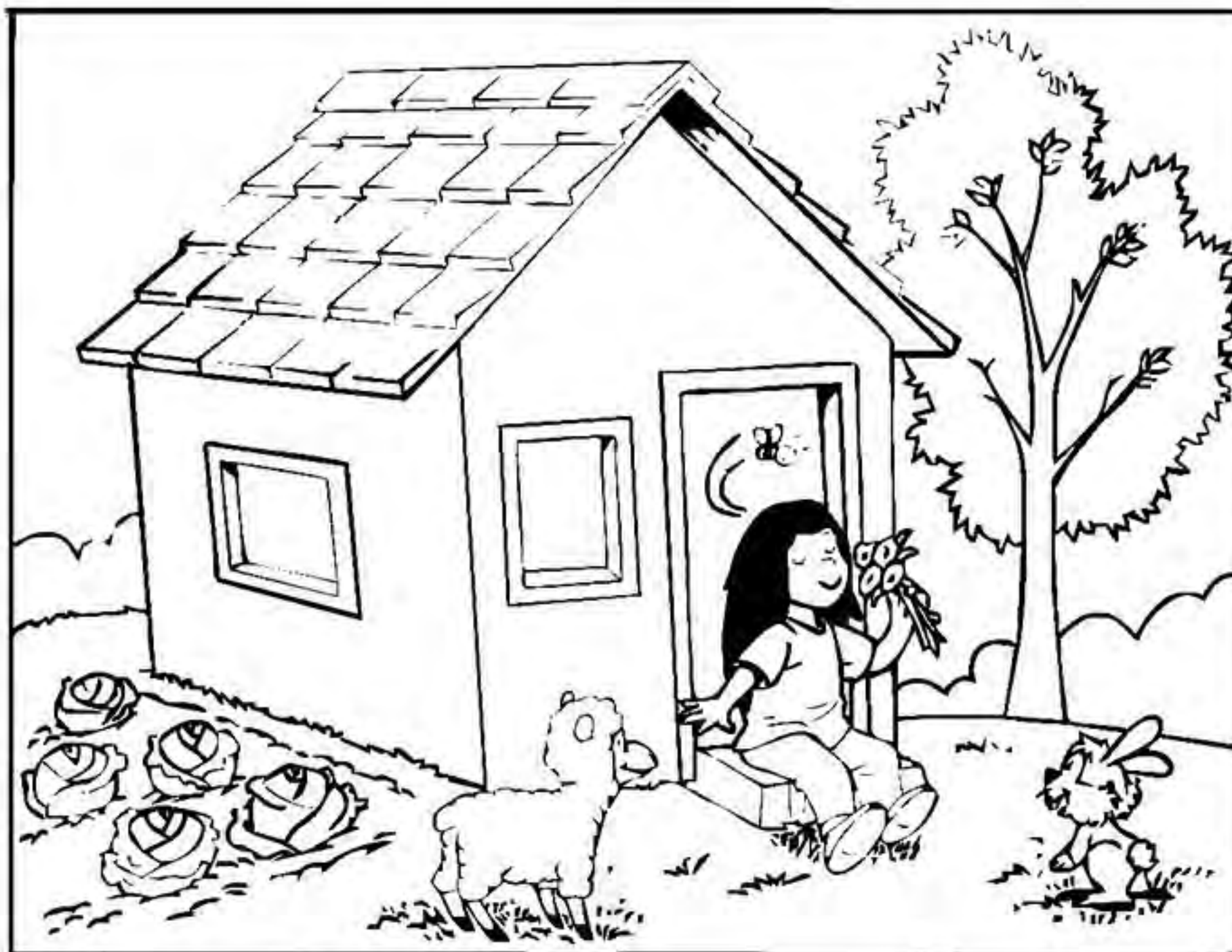

JUNTE AS SÍLABAS E FORME PALAVRAS  
QUE CONTENHAM SÍLABAS COM **LH**.

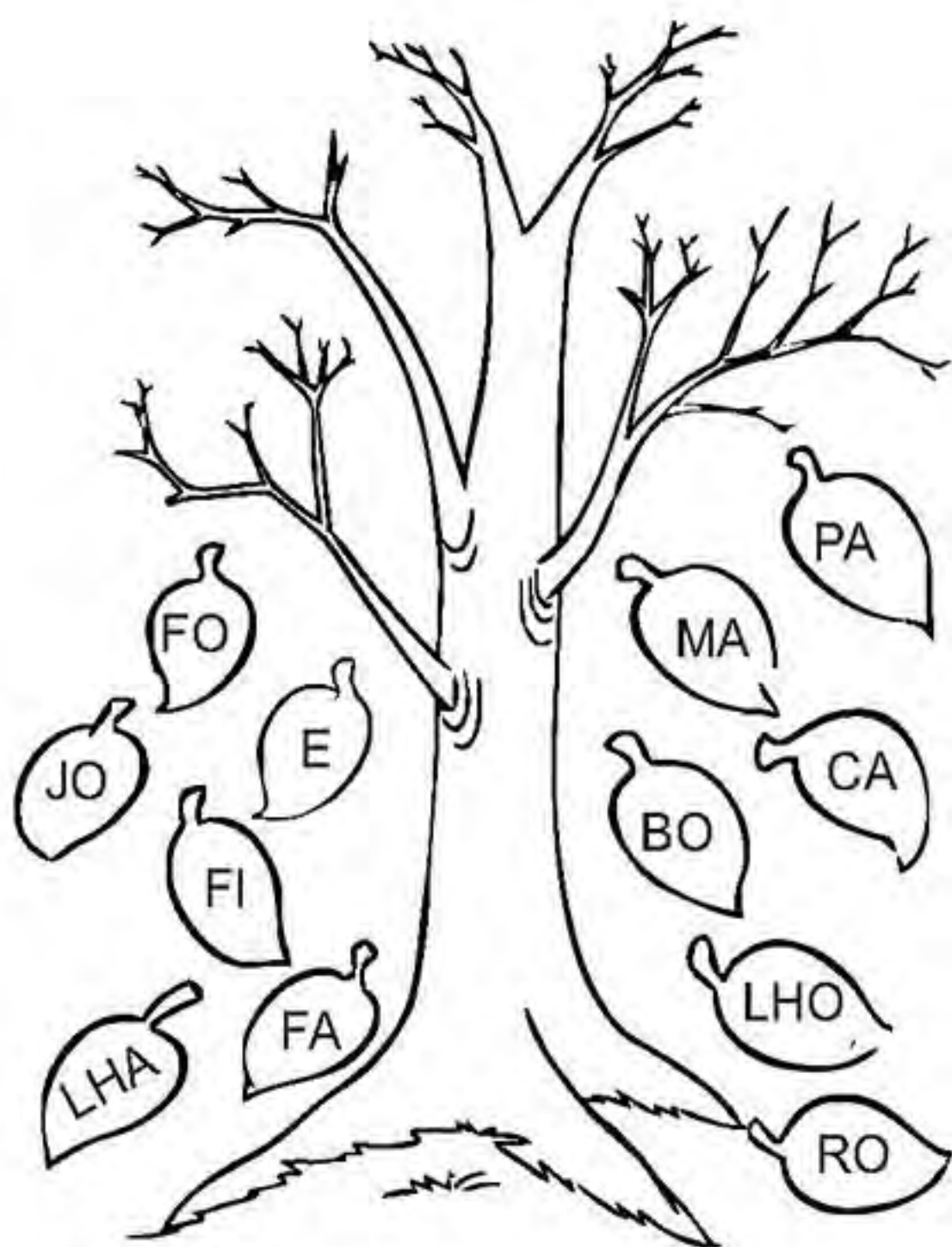

_____	_____
_____	_____
_____	_____
_____	_____
_____	_____
_____	_____

COMPLETE AS PALAVRAS COM **LI** OU **LHI**.

COE\_\_\_\_\_NHO

CO\_\_\_\_\_NHA

GA\_\_\_\_\_NHA

MA\_\_\_\_\_NHA

JOE\_\_\_\_\_NHO

ESPE\_\_\_\_\_NHO

BO\_\_\_\_\_NHO

BO\_\_\_\_\_NHO

FO\_\_\_\_\_NHA

FI\_\_\_\_\_NHO

ORE\_\_\_\_\_NHA

FO\_\_\_\_\_NHA

ESCO\_\_\_\_\_NHA

CAPE\_\_\_\_\_NHA

# DOMINOX.

The crossword puzzle grid is 10 columns wide and 10 rows high. The words 'GALHO', 'ALHO', 'LHAMA', and 'OLHO' are partially filled in. Illustrations include a corn cob, a llama, an ear, a roof, a glass of beer, a bouquet of flowers, an eye, an onion, a branch, a clown, a ball, and a mushroom.

OLHO	MILHO	ORELHA	ILHA
BOLHA	LHAMA	GALHO	TELHADO
ROLHA	RAMALHETE	PALHAÇO	ESPELHO
ALHO			

CAÇA-PALAVRAS SILÁBICO.

MA	A	ME	FE	SE	RE	CI	SA
JU	LHO	RA	ZU	BU	PO	TE	CE
CA	NE	MA	ES	PE	LHO	A	TI
FU	BI	LHE	TE	SU	CU	BE	MI
DA	PA	TE	QUE	O	RE	LHU	DO
BO	LHA	VA	TI	FA	ZI	DO	CI
MA	ÇO	PE	XU	CO	PA	PU	CA
VE	LHI	CE	ZE	E	BU	FO	LHA
NA	QUI	O	RE	LHI	NHA	ÇO	ZA
XO	SI	BU	QUA	NHO	ÇU	FI	ZI

REPOLHO	ORELHUDO	ALHO
BILHETE	JULHO	ESPELHO
BOLHA	VELHICE	ORELHINHA
COELHINHO	PALHAÇO	ABELHUDO
FOLHA	RAMALHETE	CALHA

ESCREVA PALAVRAS QUE  
TENHAM SÍLABAS COM **LH**.

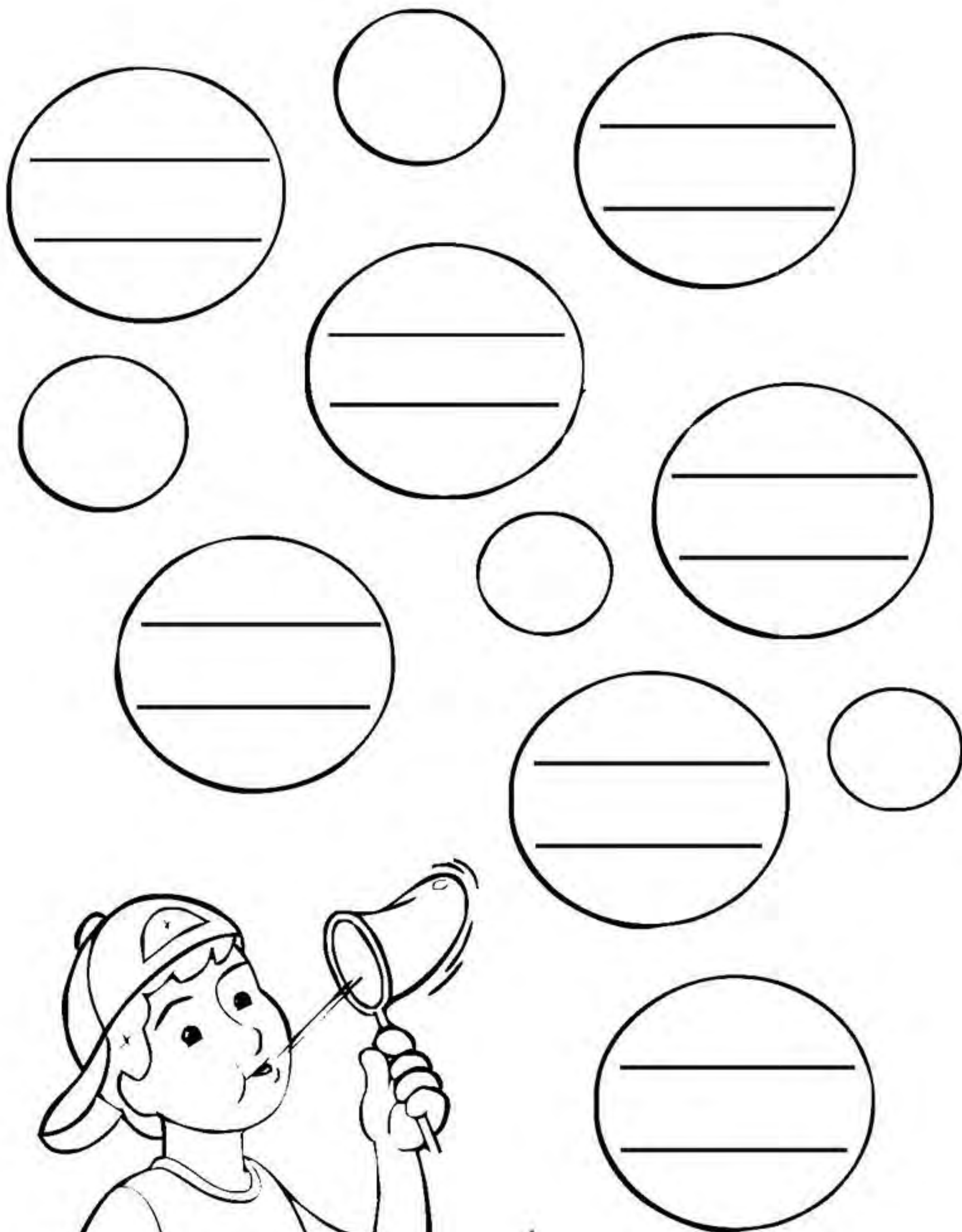



É HORA DO DITADO.

PRESTE ATENÇÃO E ESCREVA AS PALAVRAS, DE ACORDO COM AS SÍLABAS INDICADAS.

LH

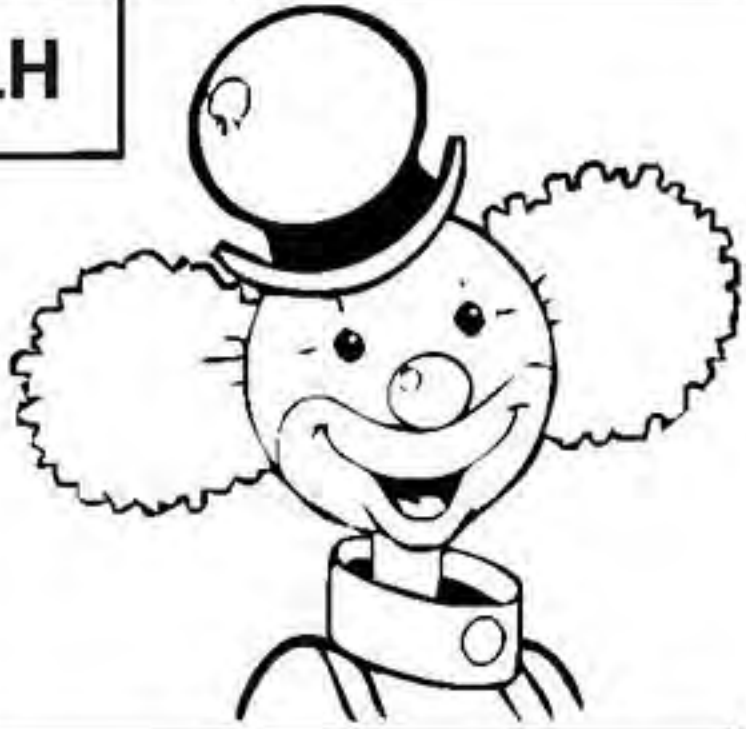

Writing lines for the first section. There are two columns of horizontal lines. The left column has five lines, and the right column has five lines. The clown's head is positioned above the first line of the left column.

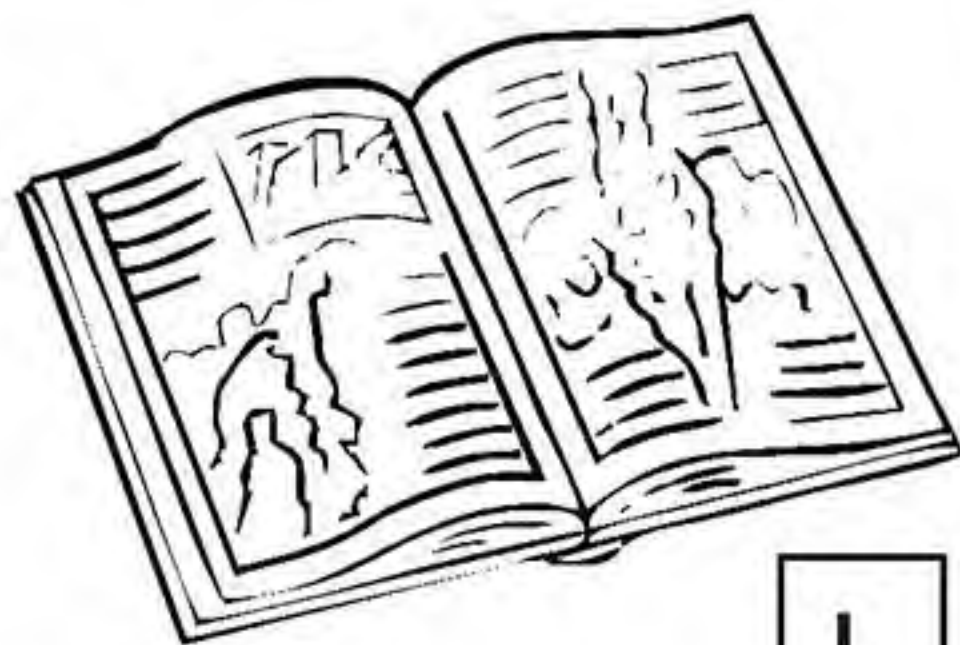

L

Writing lines for the second section. There are two columns of horizontal lines. The left column has five lines, and the right column has five lines. The open book is positioned to the right of the first line of the left column.

## A GALINHA DO VIZINHO

A GALINHA DO VIZINHO  
BOTA OVO AMARELINHO.  
BOTA 1, BOTA 2, BOTA 3,  
BOTA 4, BOTA 5, BOTA 6,  
BOTA 7, BOTA 8, BOTA 9,  
BOTA 10.



CD CANTIGAS INFANTIS,  
CIRANDA CULTURAL, pág. 141.)

CIRCULE NO TEXTO DA CANTIGA  
AS PALAVRAS QUE TÊM **NH**.

COPIE AS PALAVRAS QUE VOCÊ CIRCULOU.

COPIE.

nha - nhe - nhi - nho - nhu

nha - nhe - nhi - nho - nhu

**NHA - NHE - NHI - NHO - NHU**

nha - nhe - nhi - nho - nhu

unha	aranha
sonho	ZEZINHO
NINHO	minha
rainha	nhoque
PINHO	sardinha
comunhão	apanha
	ANINHA

nha

Nha

nha

Nha

nha nhe nhi

nho nhu

## LADAINHA

SALADA, SALADINHA  
FEIJÃO COM PIMENTA  
NA HORA DA JANTA,  
NÃO TEM QUEM AGUENTA!



SALADA, SALADINHA  
BEM TEMPERADINHA  
SAL, PIMENTA, SALSA, CEBOLINHA,  
É UM, É DOIS, É TRÊS!

DOMÍNIO PÚBLICO

CIRCULE NO TEXTO, AS PALAVRAS QUE TÊM **NH**.  
DEPOIS, ESCREVA-AS NAS FICHAS E SEPRE AS SÍLABAS.



banho caminhão

COZINHA

NINHO

SENINHA

BANHEIRO

dinheiro

pamonha

nh

nh

NH

Nh

Nha Nhe Nhi

Nho Nhu

LIGUE AS SÍLABAS E FORME PALAVRAS.

SO → NHA \_\_\_\_\_  
 LI → NHA \_\_\_\_\_  
 MI → NHA \_\_\_\_\_  
 MA → NHA \_\_\_\_\_

VI → NHE → DO \_\_\_\_\_  
 MU → NHE → CA \_\_\_\_\_

A → RA → NHI → NHA \_\_\_\_\_

VI → NHO \_\_\_\_\_  
 BA → NHO \_\_\_\_\_  
 SO → NHO \_\_\_\_\_  
 TE → NHO \_\_\_\_\_

NE → NHU → MA \_\_\_\_\_

NUMERE OS DESENHOS DE ACORDO COM AS PALAVRAS.



- 1 LINHA
- 2 ARANHA
- 3 GALINHA
- 4 SARDINHA
- 5 MINHOCAS
- 6 NINHO
- 7 RAINHA
- 8 VINHO
- 9 PIRANHA
- 10 PAMONHA
- 11 LENHA
- 12 CEGONHA



LIGUE OS NOMES AOS DESENHOS. DEPOIS,  
ESCREVA E SEPRE AS PALAVRAS EM SÍLABAS.



- VINHO
- SARDINHA
- MINHOCA
- GAFANHOTO
- PINHEIRO
- ARANHA
- NINHO
- GALINHA

ESCREVA AS PALAVRAS NO DOMINOX,  
PORÉM SEPARANDO-AS EM SÍLABAS.

- ARANHA
- NINHO
- GATINHO
- MINHOCA
- SARDINHA
- PAMONHA
- NENHUM
- GAFANHOTO
- CAMINHÃO
- NHOQUE

LEIA E COPIE AS PALAVRAS  
DE ACORDO COM A SÍLABA **NH**.

GALINHA	BANHISTA	ARIRANHA	DINHEIRO
NINHO	LENHA	MÃEZINHA	COZINHA
BANHEIRO	NENHUM	SAPINHO	MOINHO
DESENHISTA	PINHEIRO	NENHUMA	VINHO

	NHA		NHE		NHI
_____		_____		_____	
_____		_____		_____	
_____		_____		_____	
_____		_____		_____	

	NHO		NHU
_____		_____	
_____		_____	
_____		_____	
_____		_____	

FAÇA COMO O MODELO E  
CIRCULE A SÍLABA QUE TEM **NH**.

BOLA - BOLINHA

PATO \_\_\_\_\_

GATO \_\_\_\_\_

CACHORRO \_\_\_\_\_

RATO \_\_\_\_\_

AMARELO \_\_\_\_\_

CASA \_\_\_\_\_

CESTA \_\_\_\_\_

PEIXE \_\_\_\_\_

LATA - LATINHA

COPO \_\_\_\_\_

SAPO \_\_\_\_\_

JANELA \_\_\_\_\_

BOLO \_\_\_\_\_

MÃO \_\_\_\_\_

CÃO \_\_\_\_\_

MEIA \_\_\_\_\_

MINHOCA \_\_\_\_\_

DESCUBRA O SEGREDO E  
ESCREVA OUTRAS PALAVRAS.

ARANHA  
APANHA  
ARRANHA

SONHO  
NINHO  
BANHO

COELHINHO  
GATINHO  
PATINHO

CONHECEU  
AMANHECEU

NENHUM

COMUNHÃO

CIRCULE NAS PALAVRAS ABAIXO  
AS SÍLABAS FORMADAS COM **NH**.



ARANHA RAINHA PINHA SARDINHA



BANHEIRO PINHEIRO GALINHEIRO COZINHEIRA



BANHISTA ARANHINHA



NINHO PINHO LINHO GAFANHOTO



NENHUM NENHUMA

COMPLETE AS EXPRESSÕES COM AS PALAVRAS ABAIXO.

BANHO - PAMONHA - CAMINHÃO - MOINHO - PINHÃO  
ARANHA - FARINHA - VINHO - SONHO - MANHÃ  
PINHEIRO - GALINHA - CAMINHO - CANHOTO - BANHA

TEIA DE \_\_\_\_\_ BAÚ  
\_\_\_\_\_ DOCE \_\_\_\_\_ DE PORCO  
\_\_\_\_\_ ESTRANHO TOALHA DE \_\_\_\_\_  
\_\_\_\_\_ DE VENTO \_\_\_\_\_ DE TRIGO  
\_\_\_\_\_ DE SOL \_\_\_\_\_ TINTO  
\_\_\_\_\_ DE NATAL \_\_\_\_\_ COZIDO  
ALUNO \_\_\_\_\_ CURTO  
\_\_\_\_\_ CARIJÓ

COMPLETE AS FRASES  
ESCREVENDO AS PALAVRAS DA FICHA.

ANDORINHA - GALINHA - FARINHA - PAMONHA - PINHEIRO  
COZINHEIRA - PIRANHA - LINHA - NINHO - BOLINHA

EU QUEIMEI A LENHA DO \_\_\_\_\_.

A \_\_\_\_\_ É FEITA DE MILHO.

ZEZINHO JOGA \_\_\_\_\_ DE GUDE.

O SANHAÇO SAIU DO \_\_\_\_\_.

A \_\_\_\_\_ É UMA AVE.

A \_\_\_\_\_ É UM PEIXE VORAZ.

A \_\_\_\_\_ SAIU DA AGULHA.

O PATO SURROU A \_\_\_\_\_.

A \_\_\_\_\_ COLOCOU \_\_\_\_\_ NO FEIJÃO.



PINTE AS SÍLABAS QUE CORRESPONDEM AOS DESENHOS E ESCREVA AS PALAVRAS.

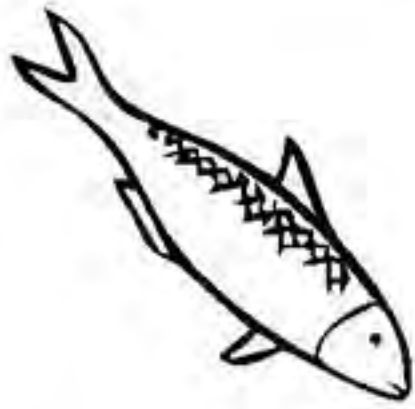

SAR | PI | DINHA



MI | NINHANHO



CA | MI | PI | NHÃO



MI | NHO | NO | CA

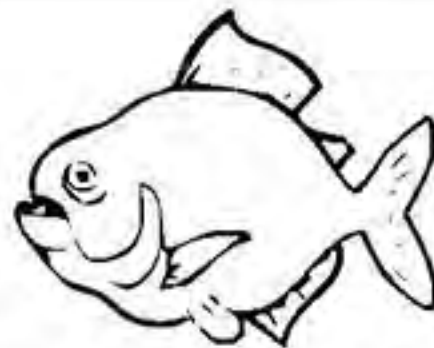

BI | PI | RANHA



GA | TI | LINHA



PA | MO | TONHA



LE | MENHANHO



PI | NHEI | SO | RO

COPIE E SEPRE AS SÍLABAS DAS PALAVRAS.

NINHO

LENHA

GATINHA

MINHOCA

COZINHA

MUNHECA

SARDINHA

NHOQUE

JUNTE AS SÍLABAS DO QUADRO,  
CONFORME O EXEMPLO E FORME PALAVRAS.

+	NHA	NHE	NHO	NHEI
SO				
GA				

+	NHA	NHO	NHÃO
PI			
CAMI			

SUBSTITUA OS SÍMBOLOS PELAS SÍLABAS  
CORRESPONDENTES E ESCREVA AS PALAVRAS.

PA ■	MI ▲	PI ■	MO ■	NHO ▲	NHA ■	CA ▲	RA ■	NHA ■
---------	---------	---------	---------	----------	----------	---------	---------	----------

■ \_\_\_\_\_ ▲ \_\_\_\_\_ ■ \_\_\_\_\_

NI ○	SO △	GA □	NHO ○	BA □	LI □	NHO □	NHA □	NHO △
---------	---------	---------	----------	---------	---------	----------	----------	----------

○ \_\_\_\_\_

□ \_\_\_\_\_

△ \_\_\_\_\_

□ \_\_\_\_\_

ORDENE AS PALAVRAS E FORME FRASES.

BICOU A MINHOCA. A GALINHA

O COZINHOU A COZINHEIRA PINHÃO.

SIGA O MODELO.

GALO

GALINHO

GA - LI - NHO

BOLA

\_\_\_\_\_

\_\_\_\_\_

PATO

\_\_\_\_\_

\_\_\_\_\_

MALA

\_\_\_\_\_

\_\_\_\_\_

JANELA

\_\_\_\_\_

\_\_\_\_\_

SAPO

\_\_\_\_\_

\_\_\_\_\_

FOFO

\_\_\_\_\_

\_\_\_\_\_

GATO

\_\_\_\_\_

\_\_\_\_\_

COMPLETE AS FRASES COM  
AS PALAVRAS ABAIXO.

FOFINHO ZEZINHO CAIXA PATINHO MINHOCA

\_\_\_\_\_ É O NOME DO MEU AMIGO.













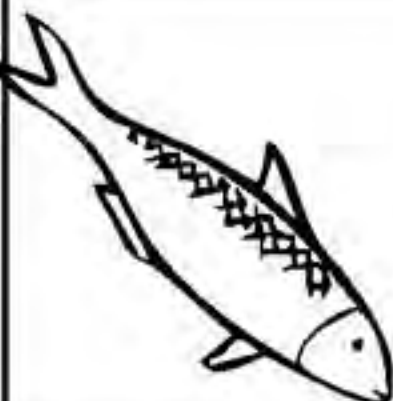

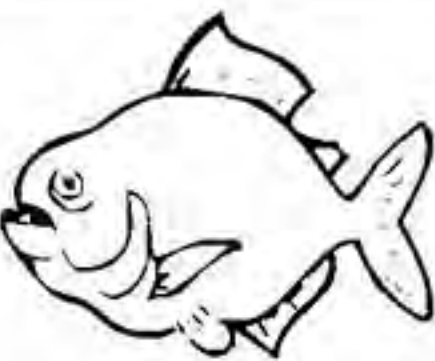

ELE PEDIU UMA \_\_\_\_\_ AO SE PAI.

NA CAIXA COLOCOU O \_\_\_\_\_.

O PATINHO É \_\_\_\_\_.

ZEZINHO DEU \_\_\_\_\_ PARA O PATINHO COMER.

RECORTE AS PALAVRAS DAS FICHAS E  
COLE-AS, DE ACORDO COM OS DESENHOS.

PIRANHA	MINHOCA	PAMONHA	GALINHA
LENHA	NINHO	ARANHA	LINHA
RAINHA	PINHEIRO	FARINHA	DINHEIRO
VINHO	CEGONHA	CAMINHÃO	SARDINHA

FORME PALAVRAS JUNTANDO AS SÍLABAS DO DESENHO.

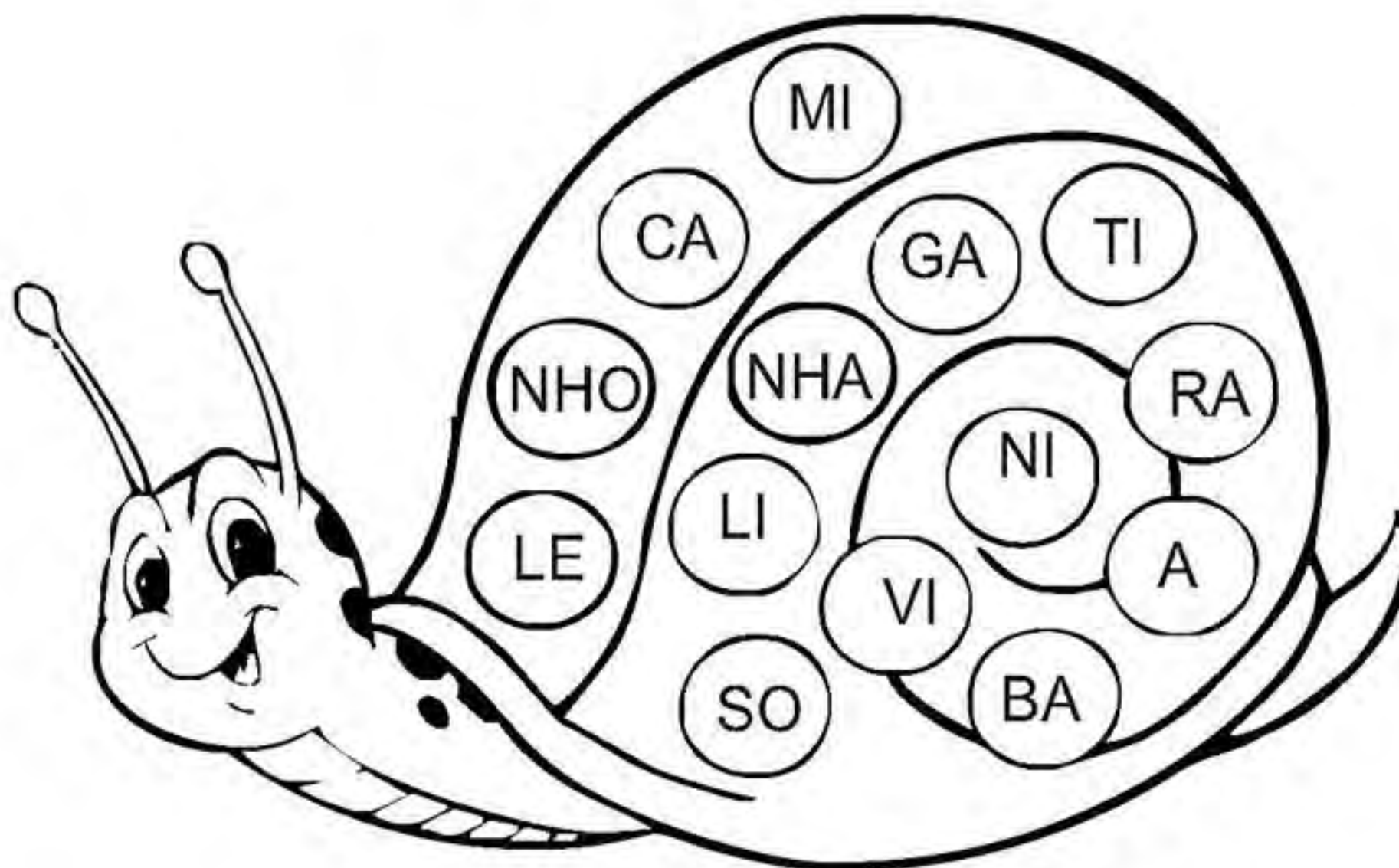

_____	_____	_____
_____	_____	_____
_____	_____	_____
_____	_____	_____

CAÇA-PALAVRAS SILÁBICO.

BA	NO	CO	SO	VI	CA
XO	GA	BE	NI	NHO	MI
CU	LI	QUI	XE	PI	NHÃO
LI	NHA	KA	DI	XU	A
BI	MI	BA	NHEI	RO	RA
SO	NHO	VE	RO	BA	NHA
BU	CA	ZE	BO	GU	TU

PINHÃO  
 LINHA  
 SONHO  
 VINHO  
 BANHEIRO  
 GALINHA  
 ARANHA  
 MINHOCA  
 NINHO  
 CAMINHÃO  
 DINHEIRO  
 BANHA

AUTODITADO.

ESCREVA PALAVRAS QUE TENHAM SÍLABAS COM **NH**.

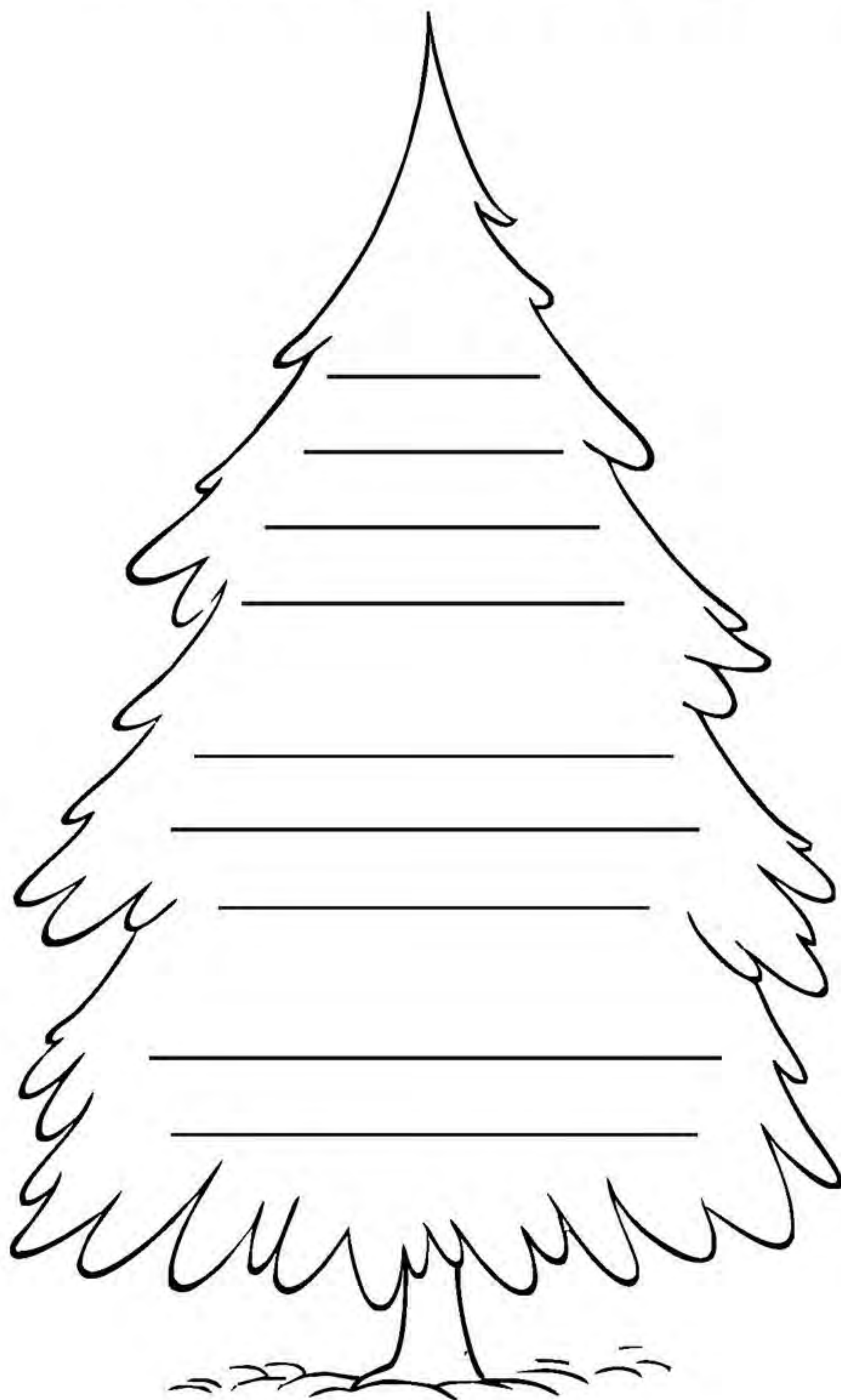

É HORA DO DITADO.

VAMOS VER QUEM APRENDEU?

The image shows a vertical stack of three rectangular boxes, each containing two horizontal lines for writing. The top and bottom boxes are connected to semi-circular shapes above and below them, which also contain a horizontal line. The middle box is connected to the top and bottom boxes by vertical lines.

## CAI, CAI, BALÃO

CAI, CAI, BALÃO,  
CAI, CAI, BALÃO,  
AQUI NA MINHA MÃO,  
NÃO CAI NÃO,  
NÃO CAI NÃO,  
NÃO CAI NÃO,  
CAI NA RUA DO SABÃO



AS MAIS BELAS CANTIGAS DE RODA,  
ED. CIRANDA CULTURAL, PÁG. 5

CIRCULE E COPIE DO TEXTO AS  
PALAVRAS QUE TERMINAM COM **ÃO**.

--	--	--	--

LEIA AS PALAVRAS.

BALÃO	MÃES	RÃS	TALÕES	CAMPEÃO	RÃ
LÃS	LEITÕES	MÃOS	MÃO	AVELÃ	PÃO
MÃE	LÃ	TALÃO	IRMÃS	AVELÃS	
LEITÃO	IRMÃ	BALÕES	PÃES	CAMPEÕES	

CIRCULE AS SÍLABAS QUE FORMAM O FINAL DAS PALAVRAS.  
OBSERVE QUE ELAS TERMINAM EM:

**ÃO**   **ÕES**   **Ã**   **ÃS**   **ÃE**   **ÃES**

LIGUE AS PALAVRAS QUE FAZEM  
PARES E DEPOIS COPIE-AS ABAIXO:



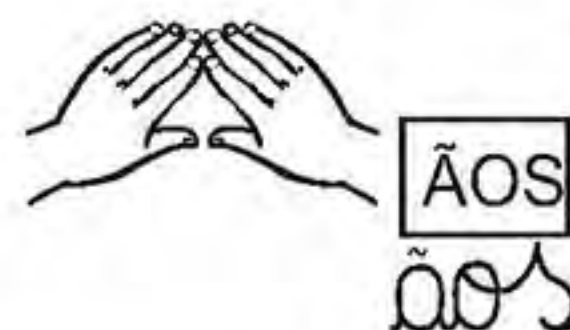

COMPLETE DE ACORDO COM O MODELO.

O PIÃO	OS PIÕES	<span style="border: 1px solid black; padding: 2px;">ÃO</span> ões	O BOTÃO	OS BOTÕES
O BALÃO	OS _____	<span style="border: 1px solid black; padding: 2px;">ÕES</span>	O LEÃO	OS _____
O FOGÃO	OS _____	ões	O LEITÃO	OS _____
O MAMÃO	OS _____		O LIMÃO	OS _____
O CORAÇÃO	OS _____		O AVIÃO	OS _____
O VIOLÃO	OS _____		O PILÃO	OS _____
O CAMINHÃO	OS _____		O PORTÃO	OS _____
O ANÃO	OS _____		O CAMARÃO	OS _____

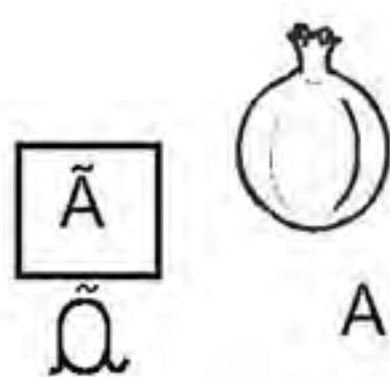

UM PÃO	DOIS PÃES	A MÃO	AS MÃOS
UM CÃO	DOIS _____	O IRMÃO	OS _____
UM CAPITÃO	DOIS _____	O ÓRGÃO	OS _____
		O ÓRFÃO	OS _____



A FÃ  
A IRMÃ  
A MAÇÃ  
A MANHÃ  
A ANÃ  
A RÃ  
A LÃ

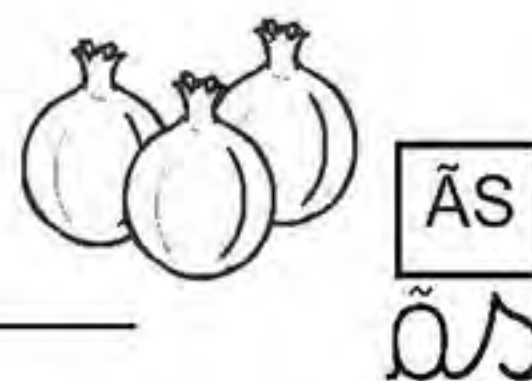

AS \_\_\_\_\_  
AS \_\_\_\_\_  
AS \_\_\_\_\_  
AS \_\_\_\_\_  
AS \_\_\_\_\_  
AS \_\_\_\_\_

LEIA OS NOMES DOS DESENHOS  
E LIGUE O DESENHO À PALAVRA CORRESPONDENTE.

FOGÃO  
BALÃO  
PIMENTÃO  
PORTÃO  
CAMINHÃO  
LAMPIÃO



VIOLÃO  
LIMÃO  
AVIÃO  
PIÃO  
LEÃO  
FEIJÃO

FORME FRASES COM AS PALAVRAS ABAIXO.

PERDIGÃO  
PARMESÃO  
ALMEIRÃO  
CAMARÃO  
ROJÃO  
SABÃO

---



---



---



---



---



---

FAÇA COMO O MODELO.

FACA	FACÃO	SALA	_____
DEDO	_____	PORTA	_____
CANECA	_____	BOLO	_____
LIVRO	_____	TIJOLO	_____
MENINO	_____	GRANDE	_____
CADEIRA	_____	BICHO	_____
VIOLA	_____	GATO	_____

COMPLETE AS FRASES COM AS PALAVRAS DO QUADRO.

MAMÃO RÃS SABÃO HORTELÃ PORTÃO  
VIOLÃO AVIÕES INJEÇÃO PIÕES FEIJÃO

EU COMI \_\_\_\_\_ MUITO GOSTOSO.

EU COMI UM \_\_\_\_\_ MUITO GOSTOSO

VOVÓ GOSTA DE CHÁ DE \_\_\_\_\_.

OS \_\_\_\_\_ TRANSPORTAM PASSAGEIROS.

O \_\_\_\_\_ ESTÁ FECHADO.

AS \_\_\_\_\_ PULARAM NA ÁGUA DA LAGOA.

RENATO TEM VÁRIOS \_\_\_\_\_ PARA BRINCAR.

ROBERTO COMPÕE, CANTA E TOCA \_\_\_\_\_.

EU LAVEI AS MÃOS COM ÁGUA E \_\_\_\_\_.

BRENDA CHOROU QUANDO TOMOU \_\_\_\_\_.

MAMÃE ESTÁ COZINHANDO \_\_\_\_\_.

**ESCREVA AS PALAVRAS NA COLUNA ADEQUADA, DE ACORDO COM O PLURAL, CORRETO.**  
 CAPITÃES - PORTÕES - IRMÃS - MÃES - IRMÃOS  
 RÃS - BOTÕES - LADRÕES - CÃES - PÃES - MÃOS  
 LÃS - ORFÃOS - AVELÃS - ÓRGÃOS - CAMPEÕES

ÃOS	ÃES	ÕES	ÃS
_____	_____	_____	_____
_____	_____	_____	_____
_____	_____	_____	_____
_____	_____	_____	_____

COMPLETE AS FRASES COM PALAVRAS DO QUADRO ACIMA.  
 OS \_\_\_\_\_ CORRERAM ATRÁS DOS \_\_\_\_\_.  
 EU PERDI OS \_\_\_\_\_ DA MINHA CAMISA.  
 PAULO LAVOU AS \_\_\_\_\_ ANTES DO LANCHE.  
 OS \_\_\_\_\_ CELSO E PAULO TRABALHAM NO QUARTEL.  
 PATRÍCIA E MARIANE SÃO \_\_\_\_\_.

LIGUE AS SÍLABAS FORMANDO PALAVRAS.

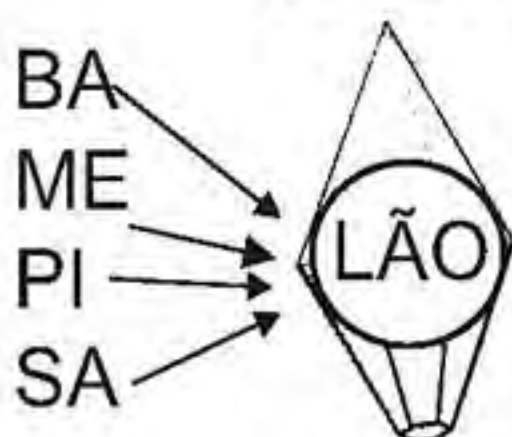

\_\_\_\_\_

\_\_\_\_\_

\_\_\_\_\_

\_\_\_\_\_

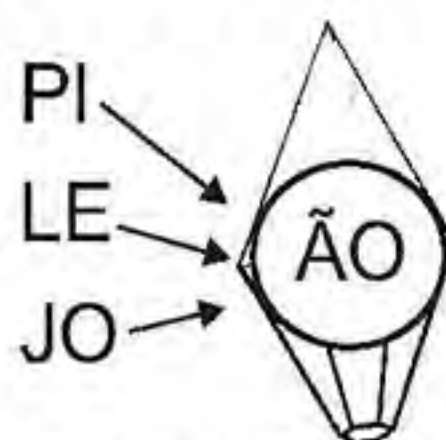

\_\_\_\_\_

\_\_\_\_\_

\_\_\_\_\_

COLOQUE O ACENTO TIL (~) ONDE É NECESSÁRIO.

MAO  
 MAMAE  
 MAMAO  
 LAS  
 ANAO

PAO  
 CAO  
 RA  
 SAO  
 ÓRGAO

PIAO  
 FOGAO  
 BOBAO  
 CAPITAES  
 LEITAO

TUBARAO  
 CAIXAO  
 MAEZINHA  
 CAMPEOES  
 LEITOES

NA TRIBO ELES VIVEM

NA TRIBO ELES VIVEM,  
COMENDO RAIZ.  
CAÇANDO E PESCANDO,  
GUERREANDO FELIZ.



AS MAIS BELAS CANTIGAS DE RODA.  
CIRANDA CULTURAL, pág. 55

CIRCULE NO TEXTO AS PALAVRAS QUE  
TERMINAM COM A LETRA **Z**. DEPOIS, COPIE  
ABAIXO, AS PALAVRAS QUE VOCÊ CIRCULOU.

az - ez - iz - oz - uz

az - ez - iz - oz - uz

**AZ - EZ - IZ - OZ - UZ**

az - ez - iz - oz - uz

CIRCULE NAS PALAVRAS AS  
SÍLABAS QUE TERMINAM COM **Z**.



ESCOLHA AS PALAVRAS E COMPLETE AS FRASES.

VELOZ INFELIZ XADREZ NARIZ PERDIZ DEZ

O RAPAZ FOI \_\_\_\_\_ E QUEBROU O \_\_\_\_\_.

O CAÇADOR NÃO CONSEGUIU CAÇAR A \_\_\_\_\_.

PORQUE ELA FOI MUITO MAIS \_\_\_\_\_.

JULINHO JÁ CONSEGUIU GANHAR \_\_\_\_\_ PARTIDAS DE \_\_\_\_\_.

COMPLETE AS PALAVRAS COM **S** OU **Z**.  
ESCREVA AO LADO, OUTRAS PALAVRAS QUE  
TERMINEM EM **AZ** **EZ** **IZ** **OZ** **UZ**.



RAI \_\_\_\_\_



ÔNIBU \_\_\_\_\_



NARI \_\_\_\_\_



LÁPI \_\_\_\_\_



XADRE \_\_\_\_\_



CAPU \_\_\_\_\_



ARRO \_\_\_\_\_



GI \_\_\_\_\_



AVESTRU \_\_\_\_\_

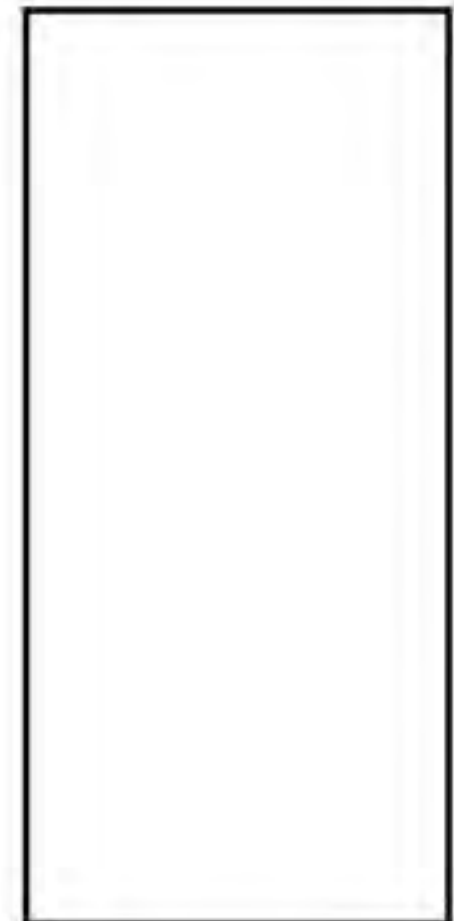

LEIA, SEPARE E JUNTE AS SÍLABAS.

RAPIDEZ		
AVESTRUZ		
INFELIZ		
CAPUZ		
VELOZ		

LEIA AS PALAVRAS DAS FICHAS, COPIE-AS  
NOS QUADROS DE ACORDO COM A INDICAÇÃO.

AZEITE - PAZ - AZEITONA - FAZ - AZEDO  
CAPAZ - FERROZ - BELEZA - GIZ - AMIZADE - DOZE  
AZULEJO - FELIZ - CHAFARIZ - CAPUZ - DEZOITO

ZEBRA	

RAPAZ	

COMPLETE COM A LETRA **Z** E DEPOIS COPIE  
E SEPRE AS PALAVRAS EM SÍLABAS.

FELI	

RAI	

CUSCU	

CARTA	

TALVE	

CAPU	

FERO	

VELO	

COMPLETE AS FRASES COM AS PALAVRAS DO QUADRO.

RAPAZ   CARTAZ   CAPUZ   XADREZ   NOZES   APRENDIZ

JOSÉ É UM BOM \_\_\_\_\_.

ELE É \_\_\_\_\_ DE MARCENEIRO.

A PROFESSORA FEZ COM OS ALUNOS UM BELO \_\_\_\_\_.

MAMÃE FAZ TORTA DE \_\_\_\_\_.

GANHEI UM \_\_\_\_\_ DE LÃ \_\_\_\_\_.

LIGUE OS NOMES AOS DESENHOS.

10



SEIS  
DEZ  
NOZ  
CRUZ  
NARIZ  
TRÊS  
RAPAZ  
DEZESSEIS

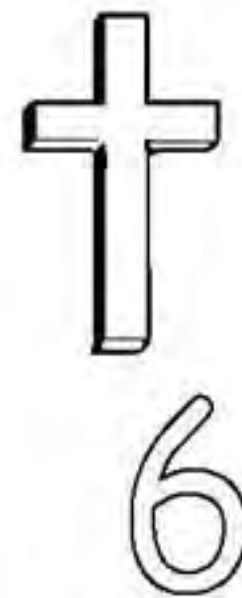

ESCREVA PALAVRAS TERMINADAS EM AZ EZ IZ OZ UZ. SIGA O MODELO.

AZ	PAZ	EZ	FEZ	IZ	RAIZ
	OZ	FEROZ	UZ	CRUZ	

COMPLETE COM Z AS PALAVRAS.

DI _____	FI _____	GI _____
FE _____	FA _____	PA _____

FAÇA COMO O MODELO.

UMA CRUZ      DUAS CRUZES

UM CARTAZ - DOIS \_\_\_\_\_

UMA CRUZ - DUAS \_\_\_\_\_

UM NARIZ - DOIS \_\_\_\_\_

UMA RAIZ - DUAS \_\_\_\_\_

UM JUIZ - DOIS \_\_\_\_\_

UMA MATRIZ - DUAS \_\_\_\_\_

UM CAPUZ - DOIS \_\_\_\_\_

UMA VOZ - DUAS \_\_\_\_\_

UM RAPAZ - DOIS \_\_\_\_\_

UMA LUZ - DUAS \_\_\_\_\_



COMPLETE AS PALAVRAS ESCRIVENDO  
AS SÍLABAS DO DESENHO.

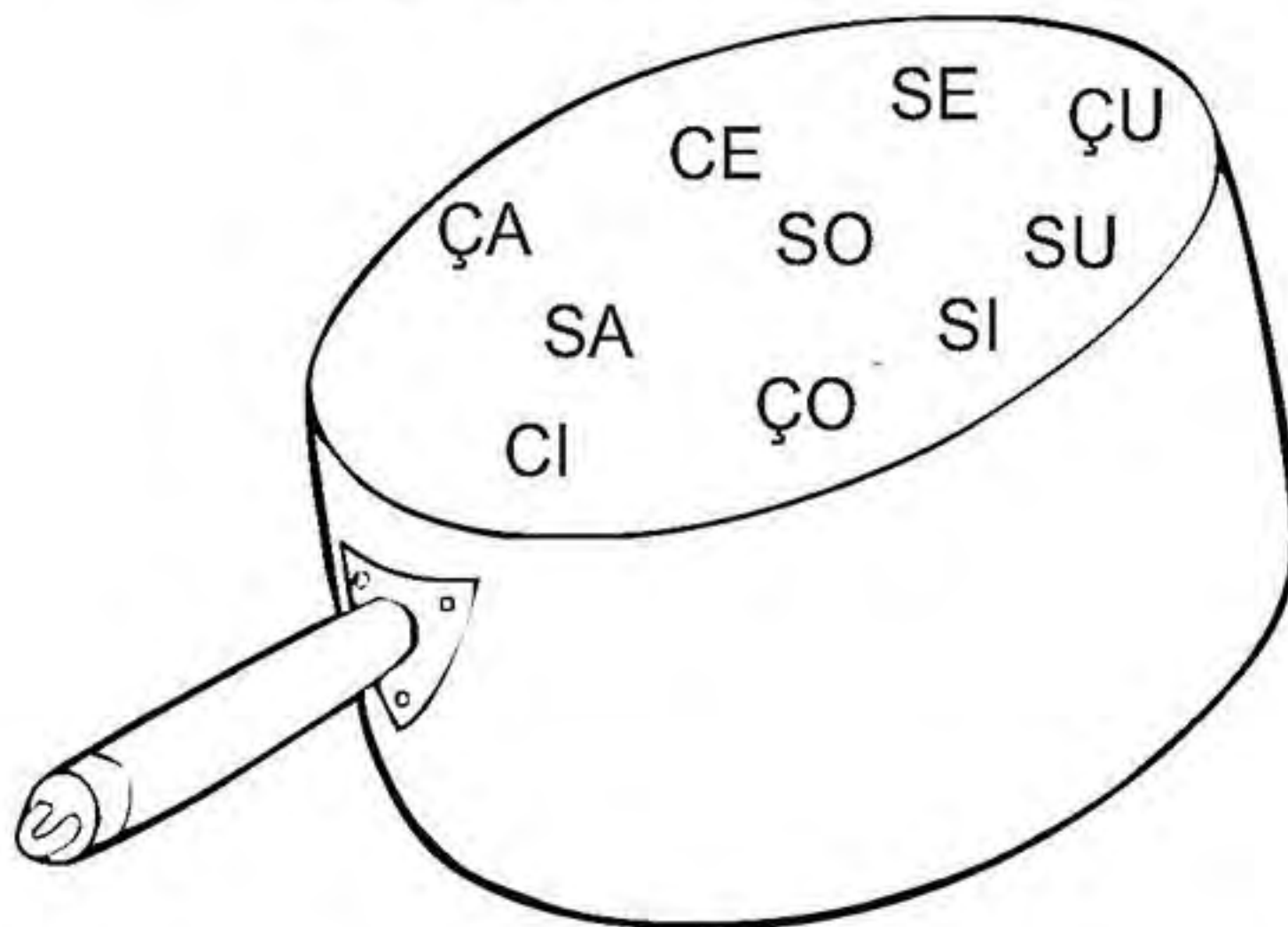

EDUCA\_\_O      \_\_BOLA      A\_\_CAR

PALHA\_\_      \_\_PÓ

OFI\_\_NA      BA\_\_A

MA\_\_      CAPA\_\_TE

CAL\_\_      PA\_\_ÊN\_\_A      LEN\_\_L

VA\_\_NA

\_\_CURI

\_\_LO      PA\_\_CA

CAL\_\_      BI\_\_CLETA

\_\_MA      \_\_NO      \_\_NEMA

\_\_DADE      LA\_\_

\_\_JO      RA\_\_O      CORA\_\_O

ENCONTRE OUTRAS PALAVRAS  
ESCONDIDAS NAS FICHAS ABAIXO.

CAÇAROLA	→	CAÇA
CEGONHA	→	
CERVEJA	→	
CEBOLA	→	
DOCERIA	→	
CERVEJADA	→	
FELICIDADE	→	
CIGARRA	→	
BACIADA	→	
CÁLICE	→	
CORAÇÃO	→	
BRAÇO	→	
CALÇA	→	

COMPLETE O DIAGRAMA COM AS PALAVRAS DO QUADRO.

LAÇO	MAÇÃ	CEGONHA	CEGO
CAPACETE	CEBOLA	CEDO	CAÇA
FUMAÇA	TECIDO	CACETETE	CEBOLINHA

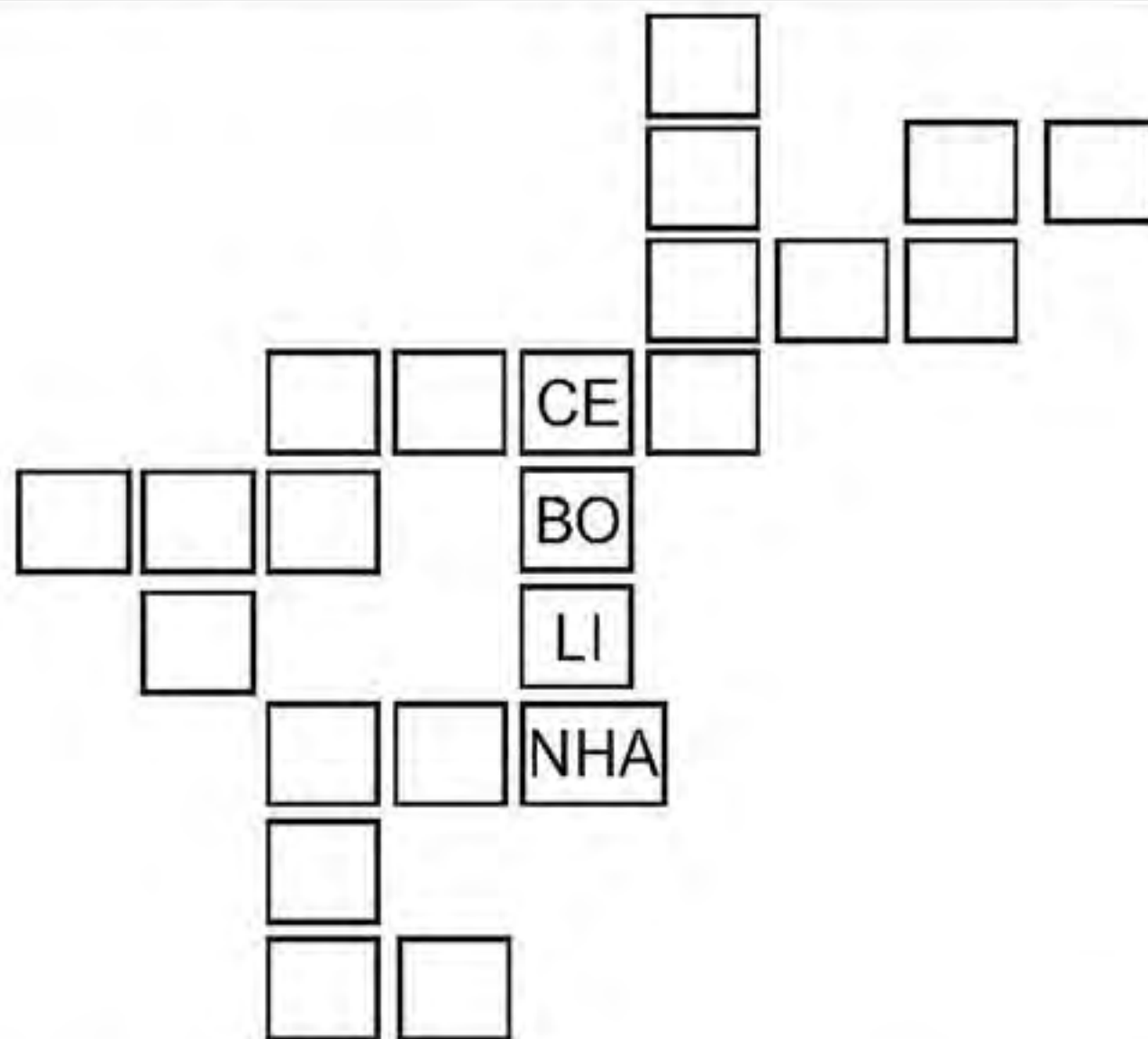

## REVISÃO.

DESCUBRA UMA MANEIRA DE SEPARAR AS PALAVRAS, ABAIXO, EM DOIS GRUPOS.

LÍNGUA                      MOLEQUE                      QUEIMA  
QUIETO                      CARANGUEJO                      GUIZO  
   ÉGUA                                      QUERO  
ÁGUIA                                      GUIA                                      QUERIDA  
   QUENTE                                      ÁGUA  
SANGUE                                      QUEDA                      AQUELE                      QUILO

PALAVRAS COM

GU

---

---

---

---

---

---

---

---

---

---

PALAVRAS COM

QU

---

---

---

---

---

---

---

---

---

---

DESCUBRA A LETRA QUE ACRESCENTADA  
EM ALGUMAS DAS PALAVRAS ABAIXO, FORMA OUTRA  
PALAVRA COM OUTRO SIGNIFICADO, E COMPLETE O QUADRO.

BICO	BOLA	CEIA	CORO
BICHO	BOLHA		
FICA	FILA	GALO	LANCE
MINA	MARCA	ROLA	SONO
TELA	TINA	TOCA	VELA

A LETRA ACRESCENTADA É

DESCUBRA O SEGREDO  
E CONTINUE O DIAGRAMA.

OLHO

COELHINHO

VELHA

JOELHO

TOALHINHA

PALMA

FILHO

BOLHINHA

FOLHINHA

AGULHA

ABELHINHA

ORELHA

LEIA AS PALAVRAS DOS RETÂNGULOS E CIRCULE AS  
SÍLABAS QUE SÃO COMUNS EM TODAS AS PALAVRAS.  
DEPOIS, COPIE NO  A SÍLABA QUE VOCÊ CIRCULOU.

CERA - DOCE - VOCÊ - CÉU

CIRCO - POLÍCIA - TECIDO - SACI

BEIÇO - LAÇO - MOÇO - OURIÇO

AÇÚCAR - AÇUCAREIRO - AÇUDE

CALÇA - TAÇA - MOÇA - ONÇA

PERIQUITO - CAQUI - ESQUILO - QUILO

QUEIJO - QUERIDA - QUEDA - PEQUENO

AQUÁRIO - QUATRO - QUADRO - QUATI

REVISÃO **CH** **LH** **NH**.

LEIA E ESCREVA AS PALAVRAS DO QUADRO, SEPARANDO-AS DE ACORDO COM AS LETRAS INDICADAS.

**CH**



_____	_____
_____	_____
_____	_____
_____	_____

**LH**

_____	_____
_____	_____
_____	_____
_____	_____

**NH**

_____	_____
_____	_____
_____	_____
_____	_____

ARANHA	CHEIRO	FILHOTE	MILHO
PAMONHA	MANHÃ	VERMELHO	CHUMBO
FILHO	CHIADO	BOLINHO	COELHINHO
BILHETE	COMPANHIA	BOLHA	CHITA
CAMINHÃO	CHAVE	MINHOCA	BICHO
BANHO	VELHICE	GANHA	CHOCO

REVISÃO.

VAMOS VER SE VOCÊ APRENDEU?  
 RECORTE AS FICHAS E COLE  
 CORRETAMENTE NO QUADRO.

	CH	NH	LH
A			
O			
EI			
GA			
BO			
FI			
ÃO			
U			
IA			

MURCHA	PUNHA	CANHÃO	FILHO
TACHO	BICHÃO	GANHO	GALHÃO
ACHAR	BOCHA	GANHEI	GALHO
GANHA	FININHA	ALHO	FILHINHA
BOLINHO	ARANHA	FICHINHA	ORELHA
CHEIO	GANCHO	MILHEIRO	BOLHA
BULHA	GANHARIA	MALHARIA	ACHARIA



DESCUBRA A FAMÍLIA SILÁBICA (EM ESTUDO) E LEVE O PALHAÇO ATÉ O CIRCO, PINTANDO AS FICHAS DESSAS PALAVRAS.



PALHAÇO

MOÇA

GALHO

CEREJA

CHUVA

CHUVISCO

JOELHO

DOCE

MILHO

COELHO

FILHINHO

QUILO

PALHA

QUEIJO

ORELHUDO

ILHA

UNHA

AGULHA

PINGÜIM

ÁGUA

ORELHÃO

TRANQUÍLO

OVELHA

CHAPÉU

CALHA

TELHADO

CENOURA

BILHETE

GARGALHADA

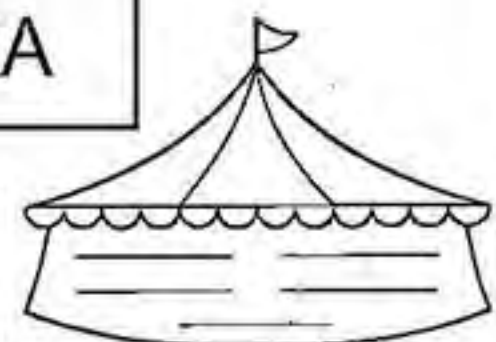









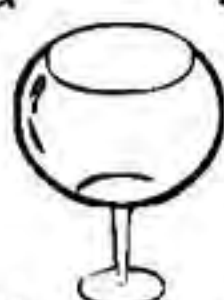

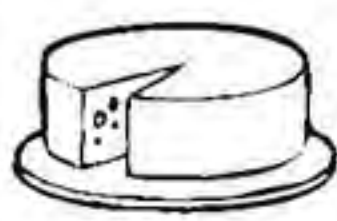

FICHAS PARA BINGO.

















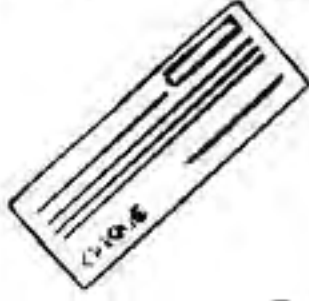
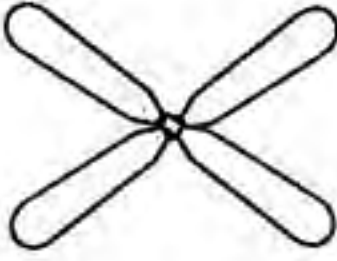









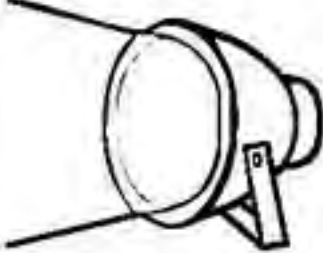



A	ÇA	QUA		GUA
E	CE	QUE	GE	GUE
I	CI	QUI	GI	GUI
O	ÇO	QUO		
U	ÇU			
ÃO	ÇÃO			
A	HA	CHA	LHA	NHA
E	HE	CHE	LHE	NHE
I	HI	CHI	LHI	NHI
O	HO	CHO	LHO	NHO
U	HU	CHU	LHU	NHU
ÃO	HÃO	CHÃO	LHÃO	NHÃO

# SILABÁRIO

<p>ça      çã</p>  <p>ÇA      Çã</p>	<p>qua      quã</p>  <p>QUA      Quã</p>	<p>/</p>	<p>gua      guã</p>  <p>GUA      Guã</p>	<p>/</p>
<p>ce      cã</p>  <p>CE      Cã</p>	<p>que      quã</p>  <p>QUE      Quã</p>	<p>ge      gã</p>  <p>GE      Gã</p>	<p>gue      guã</p>  <p>GUE      Guã</p>	<p>/</p>
<p>ci      cã</p>  <p>CI      Cã</p>	<p>qui      quã</p>  <p>QUI      Quã</p>	<p>gi      gã</p>  <p>GI      Gã</p>	<p>gui      guã</p>  <p>GUI      Guã</p>	<p>/</p>
<p>ço      çã</p>  <p>ÇO      Çã</p>	<p>quo      quã</p> <p>QUO      Quã</p>	<p>/</p>	<p>/</p>	<p>/</p>
<p>çu      çã</p>  <p>ÇU      Çã</p>	<p>/</p>	<p>/</p>	<p>/</p>	<p>/</p>
<p>/</p>	<p>/</p>	<p>/</p>	<p>/</p>	<p>/</p>

# SILABÁRIO

nha nha  NHA Nha	lha lha  LHA Lha	cha cha  CHA Cha	ha ha  HA Ha	
nhe nha  NHE Nha	lhe lhe  LHE Lhe	che che  CHE Che	he he  HE He	
nhi nhi  NHI Nhi	lhi lhi  LHI Lhi	chi chi  CHI Chi	hi hi  HI Hi	
nho nho  NHO Nho	lho lho  LHO Lho	cho cho  CHO Cho	ho ho  HO Ho	
nhu nhu  NHU Nhu	lhu lhu  LHU Lhu	chu chu  CHU Chu	hu hu  HU Hu	
nhão nhão  NHÃO	lhão lhão  LHÃO	chão chão  CHÃO		

A coleção “CIRANDA DAS SÍLABAS” é composta por seis volumes, organizados em lições que apresentam atividades seqüenciais. Nos volumes 1 e 2, as lições envolvem o trabalho com vogais e consoantes, facilitando o aprendizado do alfabeto. Os demais volumes estão voltados à sistematização das famílias silábicas, permitindo, dessa maneira, que o professor avalie sistematicamente os avanços de seus alunos, fazendo intervenções adequadas ao perceber que algum aluno não está aprendendo de forma satisfatória.



Ruth Rozendo Caputo

ISBN 978853800010-5



9 788538 000105



*Ciranda Cultural*

[www.cirandacultural.com.br](http://www.cirandacultural.com.br)