

CIRANDA DAS



A coleção “CIRANDA DAS SÍLABAS” é composta por seis volumes, organizados em lições que apresentam atividades seqüenciais. Nos volumes 1 e 2, as lições envolvem o trabalho com vogais e consoantes, facilitando o aprendizado do alfabeto. Os demais volumes estão voltados à sistematização das famílias silábicas, permitindo, dessa maneira, que o professor avalie sistematicamente os avanços de seus alunos, fazendo intervenções adequadas ao perceber que algum aluno não está aprendendo de forma satisfatória.

Ruth Rozendo Caputo

ISBN 978853800010-5



9 788538 000105



Ciranda Cultural
www.cirandacultural.com.br



Ciranda Cultural

Volume 2

abelha - a
abelha - a

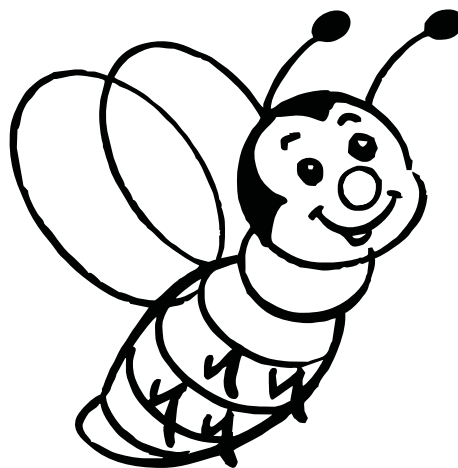

Ana - A
Ana - a

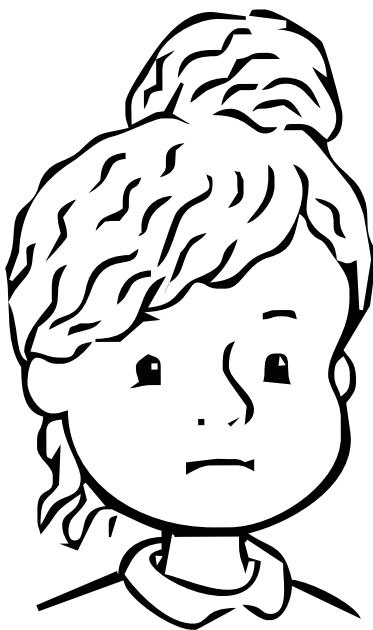

a a A A

búfalo – b

búfalo – b

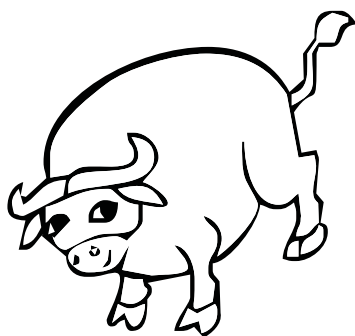

Beatriz – B

Beatriz – B

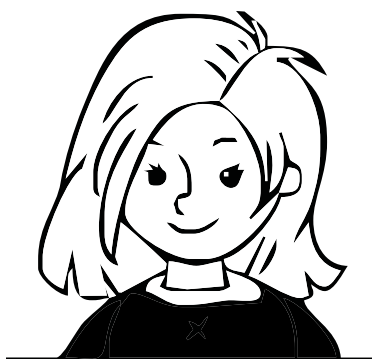

b b B B

a q u b A C S Z m X N O P C G V
p
c
c
c
o
g
s
a
s
u
D
q
N
G
C
h
C b v H a B q A C u z m O X

cavalo – c

cavalo – c

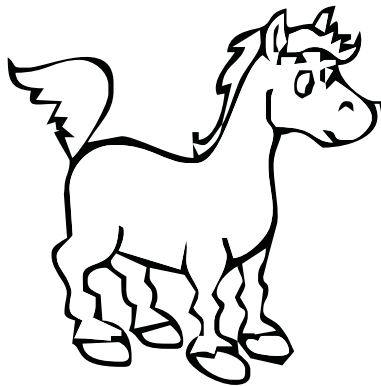

Caio – C

Caio – C



c c C C

Dinossauro – d

dinossauro – d

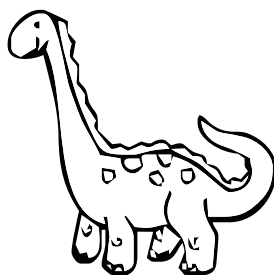

Daniel – D

Daniel – D

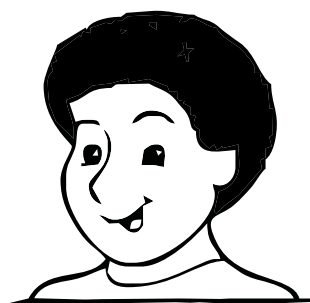

d d D D

a q u b A C S Z m X N O P C G V
p
c
c
c
o
g
s
a
s
u
D
q
N
G
C
h
C b v H a B q A C u z m O X

elefante – e

elefante – e

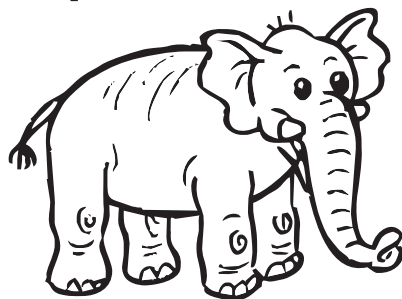

Elza – E

Elza – E

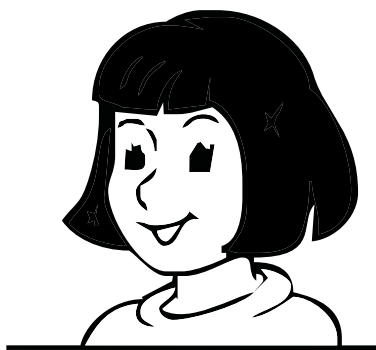

e e E E

foca – f

foca – f



Fernanda – F

Fernanda – F

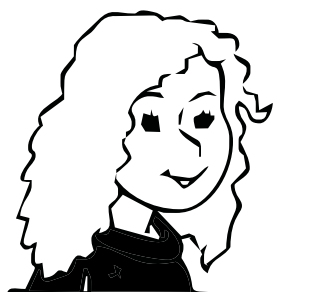

f f F F

gato – g

gato – g



Gabriela – G

Gabriela – G



g g G G

hipopótamo – h
hipopótamo – h

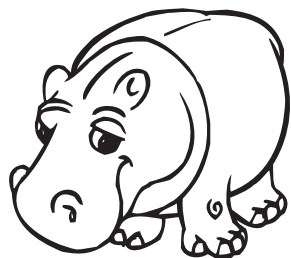

Helena – H
Helena – H

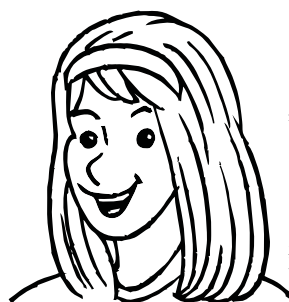

h h H H

iguana – i
iguana – i

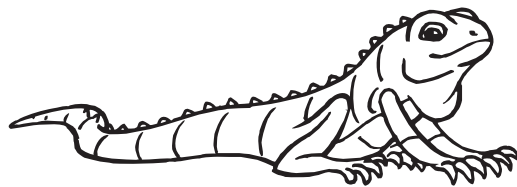

Irineu – I
Irineu – I



i i I I

jabuti – j
jabuti – j

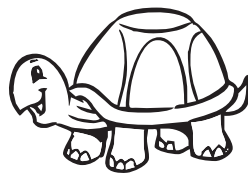

Júlia – J
Júlia – J

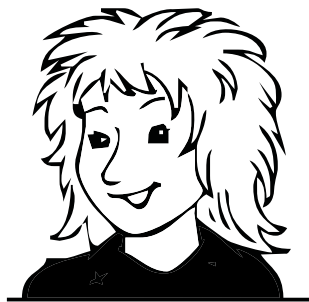

j j J J

ketchup – k

ketchup – k



Kátia – K

Kátia – K

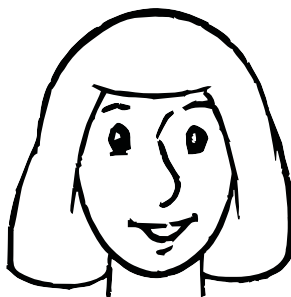

k k K K

leão - l

leão - l



Lucas - L

Lucas - L

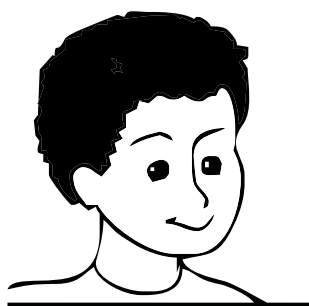

l l L L

macaco – m

macaco – m



Maria – M

Maria – m

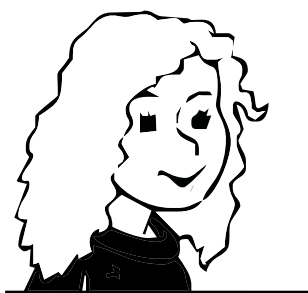

m m M m

naja – n

naja – n

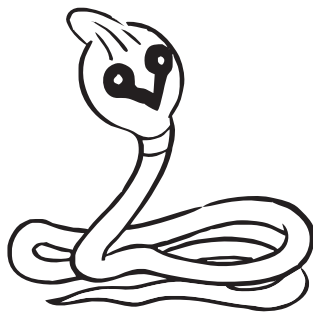

Nádia – N

Nádia – n

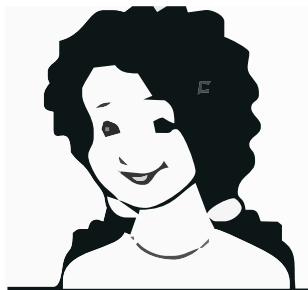

n n N n

onça – o

onça – o

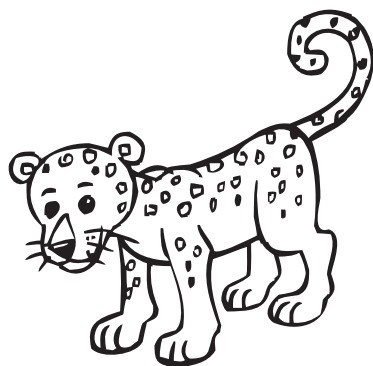

Odair – O

Odair – O

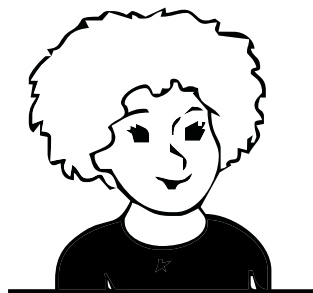

o o O O

pingüim – p

pingüim – p

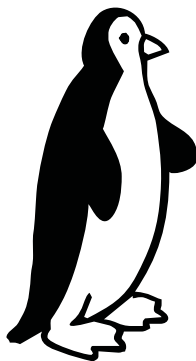

Paula – P

Paula – P



p p P P

quati – q

quati – q



Quirino – Q

Quirino – Q

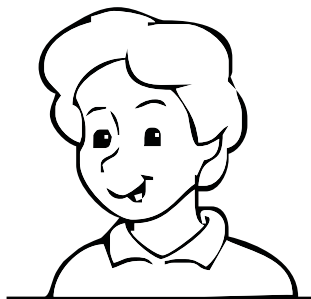

q q Q Q

rato – r

rato – r

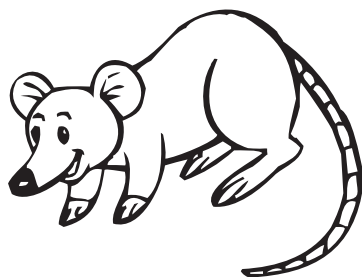

Rafaela – R

Rafaela – R



r r R R

a q u b A C S Z m X N O P C G V

P

C

U

V

O

Q

S

A

S

U

D

Q

Z

G

C

H

G

A

S

U

Q

H

Z

S

P

R

D

A

M

O

V

P

N

sapo – s
sapo – s

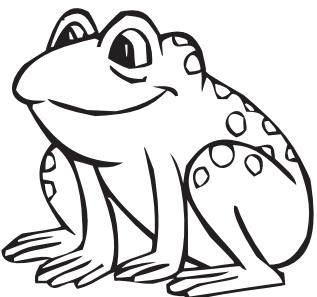

Sara – S
Sara – S

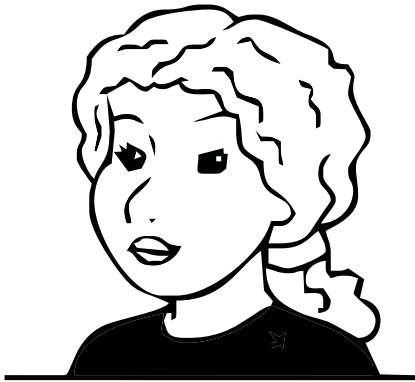

s s S S

C b v H a B q A C u z m O X

tubarão – t

tubarão – t

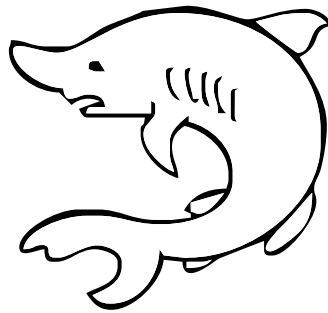

Taís – T

Taís – T



t t T T

a q u b A C S Z m X N O P C G V

p

c

z

v

o

g

s

a

s

u

d

q

n

g

c

h

с b v H a B q A C u z m O X

urso – u
urso – u



Ulisses – U
Ulisses – u



u u U u

vaca – v
vaca – u

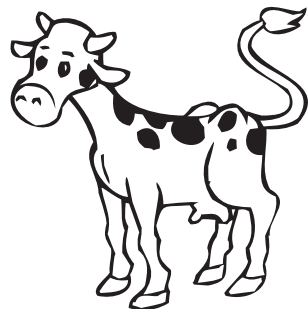

Vera – V
Vera – U



v u V U

walkman – w

walkman – w



Wilson – W

Wilson – W

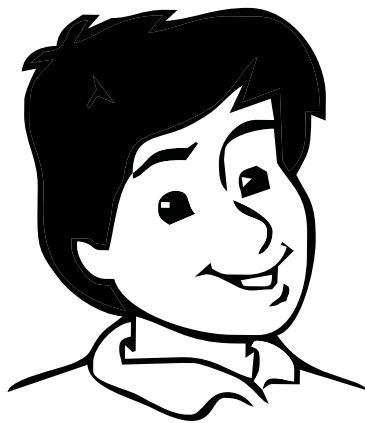

w w W W

peixe – x
peixe – x

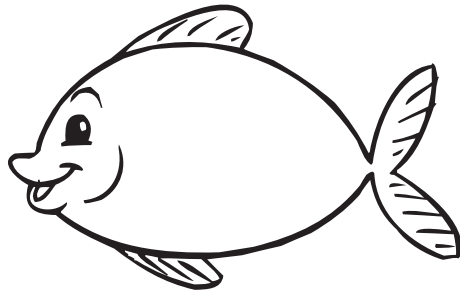

Xuxa – X
Xuxa – x



x x X x

yakult – y

yakult – y



Yan – Y

Yan – Y



y y Y Y

zebra – z

zebra – z

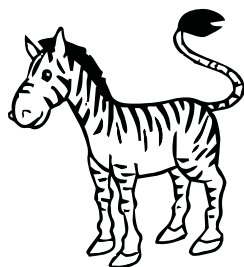

Zeca – Z

Zeca – Z

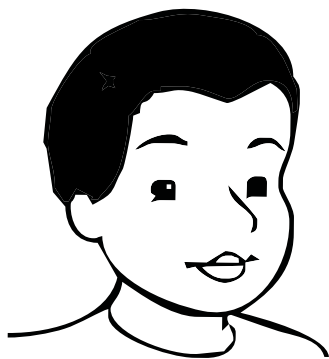

z

z

Z

Z

VAMOS COLORIR AS
LETRAS DO ALFABETO?

A

B

C

D

E

F

G

H

I

continua...

continuação

J

K

L

M

N

O

P

Q

R

continua...

continuação

S

T

U

V

W

X

Y

Z

AGORA É A VEZ DAS LETRAS MINÚSCULAS.

a b c d e

f g h i j k

l m n o p q

r s t u v

w x y z

ESCREVA AS LETRAS DO ALFABETO

A

A

B

B

C

C

D

D

E

E

F

F

continua...

continuação

G

G

H

H

I

I

J

J

K







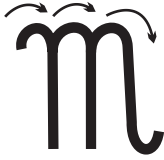

K

L

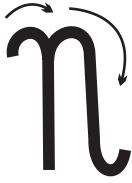
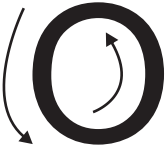
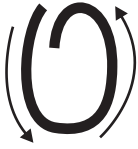
L

continua...

continuação

continua...

continuação

S

S

T

T

U

U

V

V

W

W

X

X

Y

Y

Z

Z

a q u b A C S z m x N O p c g v

p

c

ç

v

o

q

s

a

s

u

d

q

n

g

ç

h

c

b

A CONFUSÃO DAS LETRAS

QUANTAS LETRAS VOCÊ É CAPAZ DE ENCONTRAR? PINTE CADA UMA DE UMA COR.

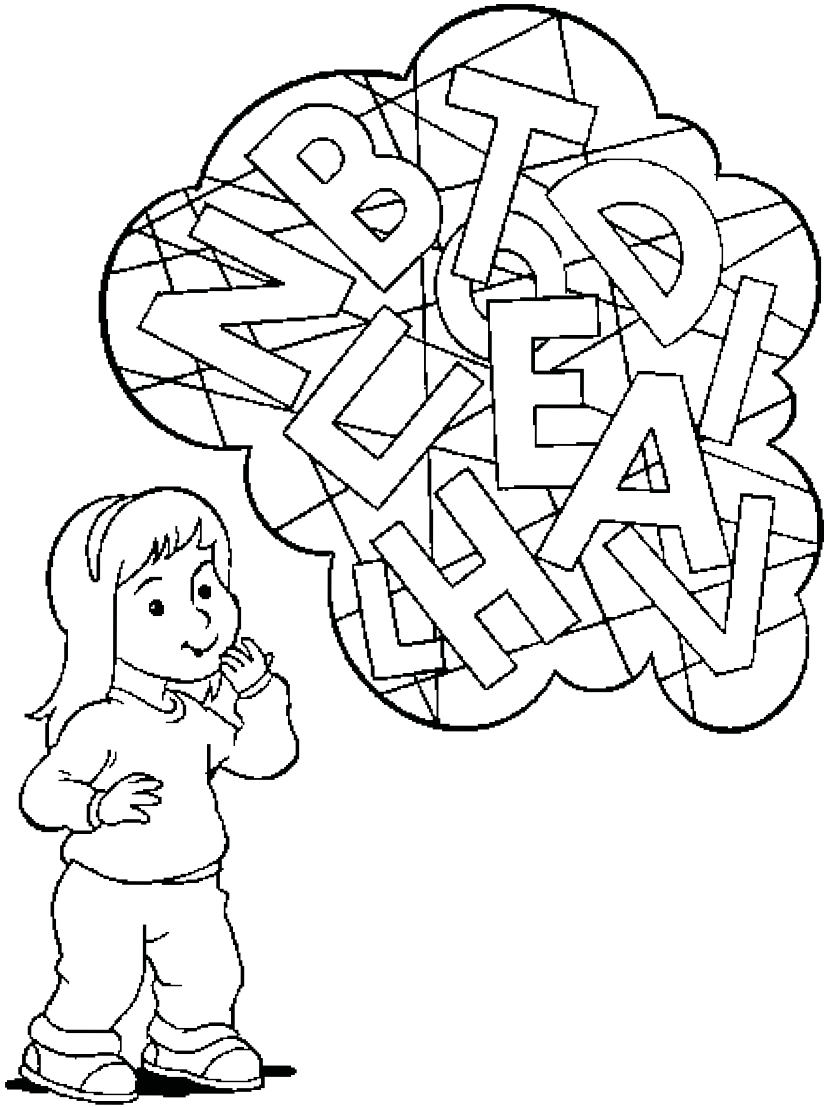

COPIE AS LETRAS QUE VOCÊ PINTOU.

c b v h a B q A C u z m O x

ESCREVA O ALFABETO
MAIÚSCULO E MINÚSCULO.

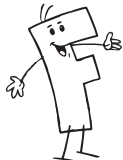
A	B	C	D	E	F	G
H	I	J	K	L	M	N
O	P	Q	R	S	T	U
V	W	X	Y	Z		

a	b	c	d	e	f	g
h	i	j	k	l	m	n
o	p	q	r	s	t	u
v	w	x	y	z		

a q u b A C S z m X N O p c g v

AJUDE BRANCA DE NEVE CHEGAR ATÉ DUNGA, PASSANDO PELO CAMINHO DO ALFABETO.

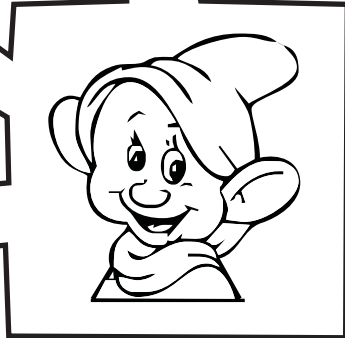
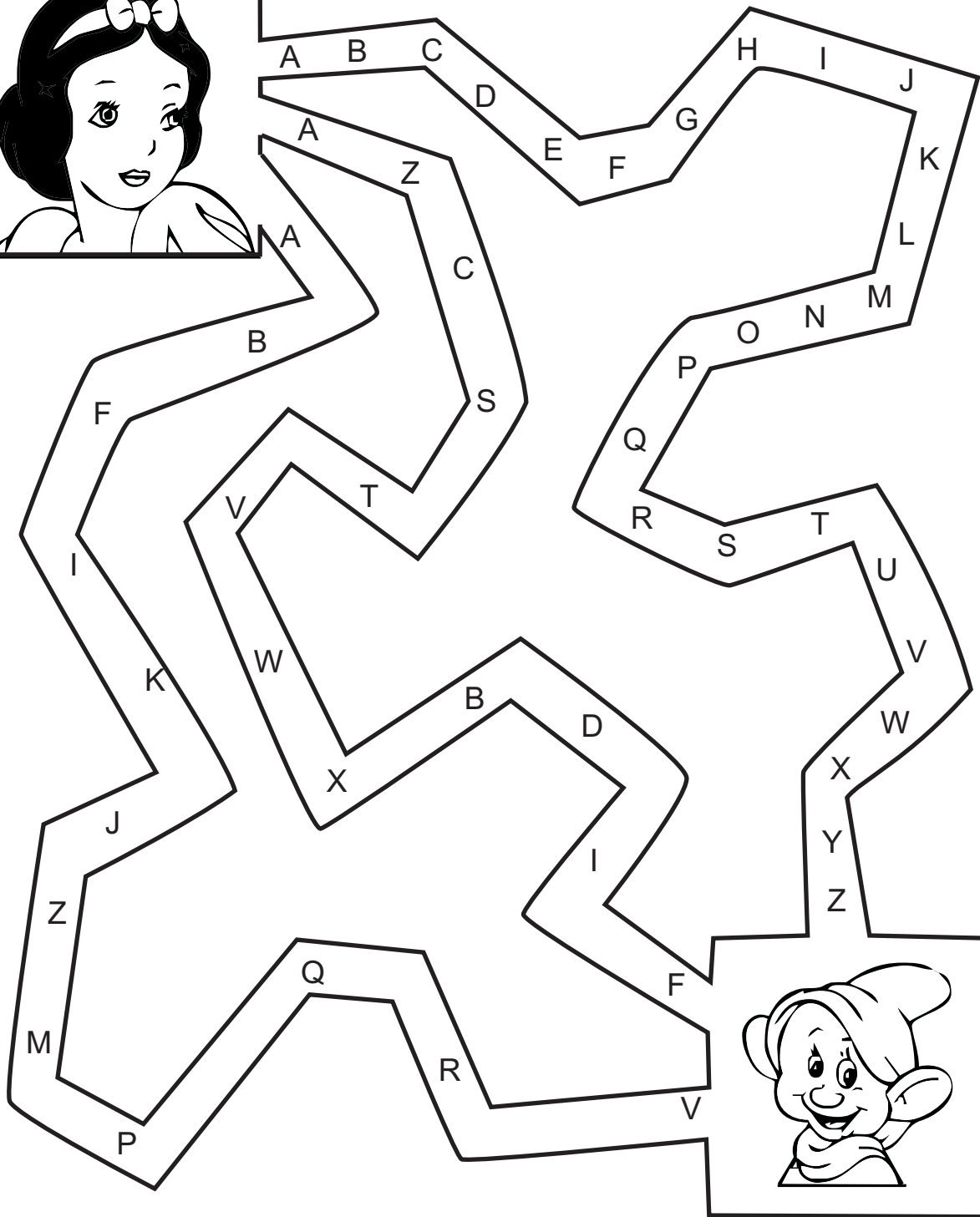

C b v H a B q A C u z m O X

ESCREVA O ALFABETO DE ACORDO COM A PRIMEIRA LETRA DE CADA DESENHO.

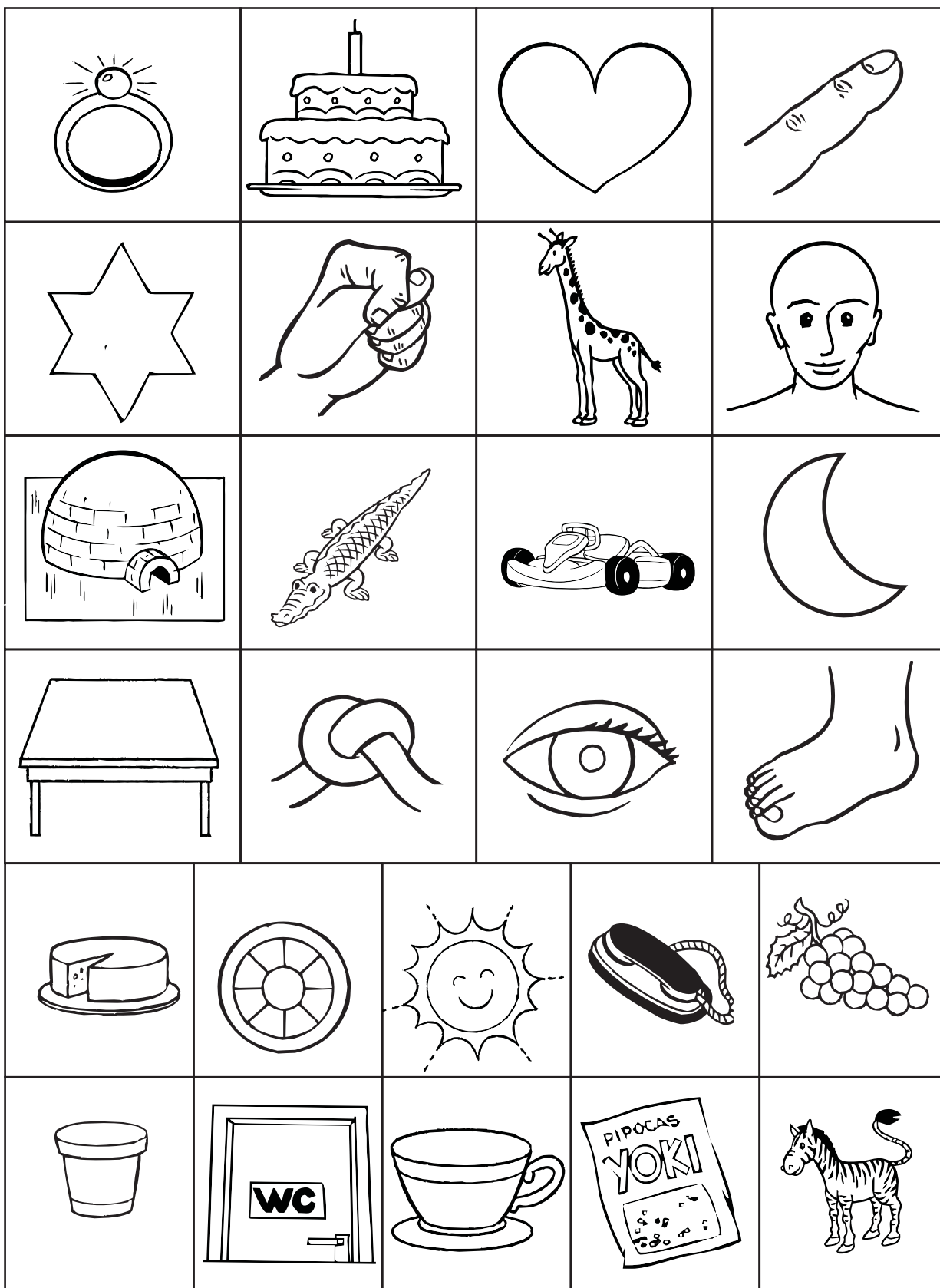

COLE FIGURAS QUE INICIE COM
CADA UMA DAS LETRAS ABAIXO.

A	B	C
D	E	F
G	H	I

continua...

continuação

J	K	L
M	N	O
P	Q	R

continua...

continuação

S

T

U

V

W

X

Y





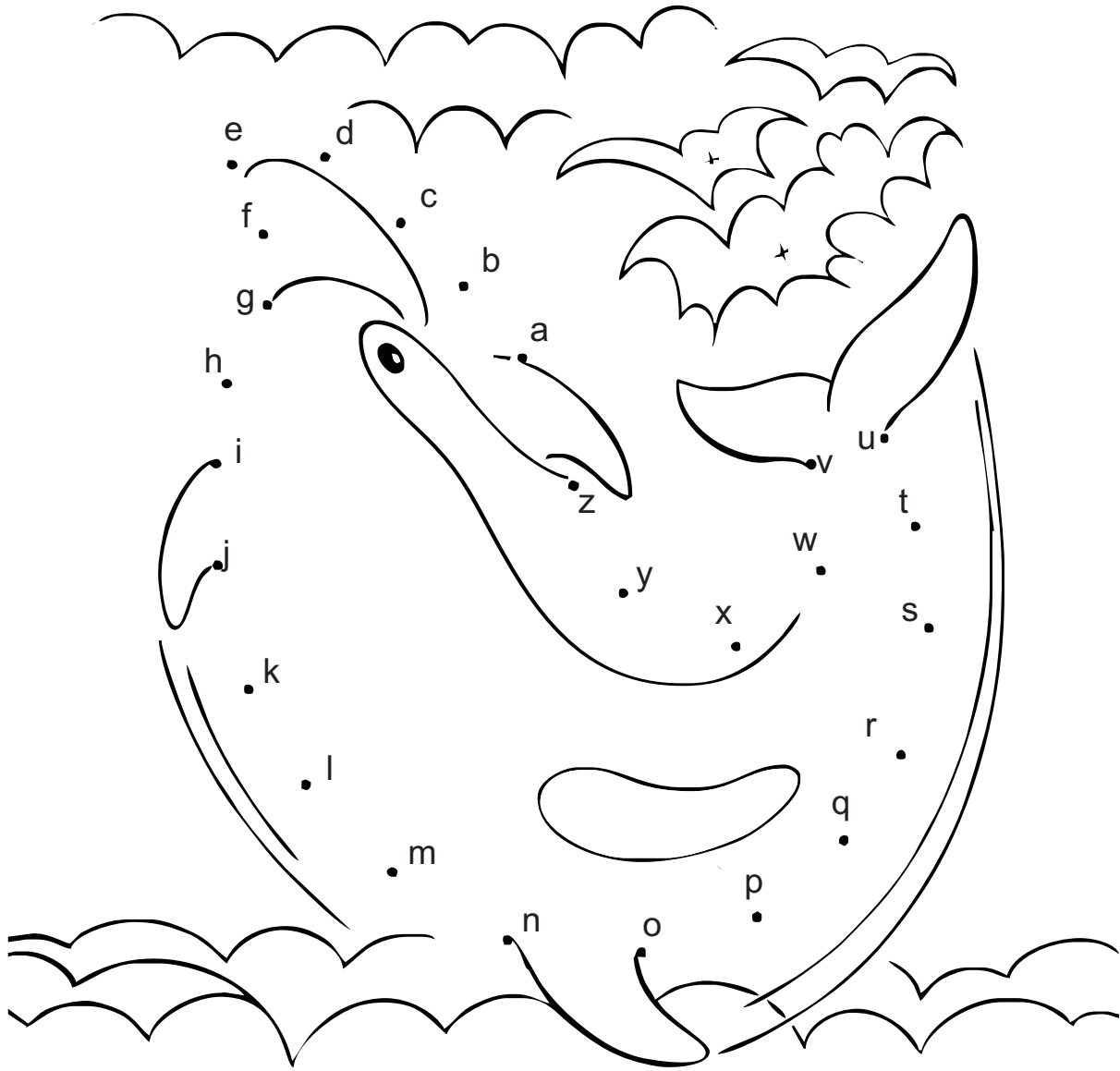





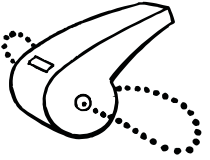

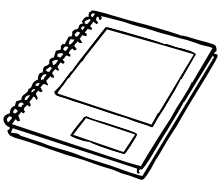
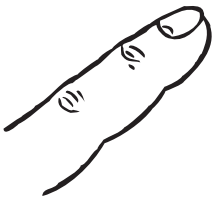





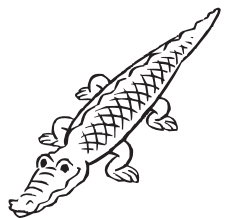

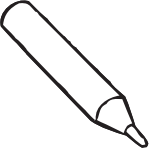

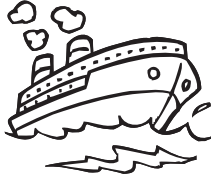
Z

LIGUE AS LETRAS MINÚSCULAS SEGUINDO O ALFABETO E DESCUBRA O DESENHO.

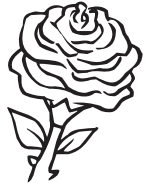
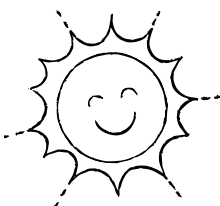
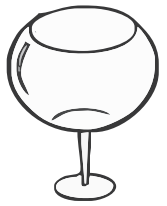

a q u b A C S Z m X N O P C G V

ESCREVA A LETRA INICIAL
DE CADA DESENHO.

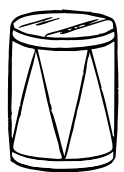
C b v H A B q A C U Z m O X

a q u b A C S z m X N O p c G V

ESCREVA O SEU NOME.

REPRESENTE ATRAVÉS DE
DESENHO CADA LETRA DO SEU NOME.

C b v H a B q A C u z m O X

VEJA E LEIA AS LETRAS QUE FORMAM NOSSO ALFABETO.

A B C D E F G H
I J K L M N O P Q
R S T U V W X Y Z

COPIE-AS NO QUADRO.

ESCREVA O SEU NOME USANDO UMA COR PARA CADA LETRA. USE A MESMA COR PARA CIRCULAR NO ALFABETO AS LETRAS QUE VOCÊ UTILIZOU.

FAÇA O MESMO ESCREVENDO UM OUTRO NOME.

OBSERVE AS LETRAS MINÚSCULAS. LEIA TODAS ELAS.











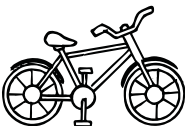

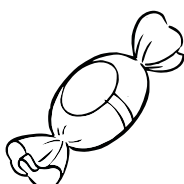
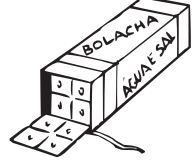

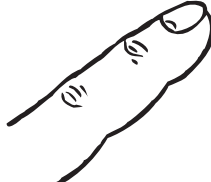

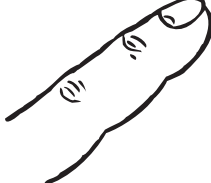
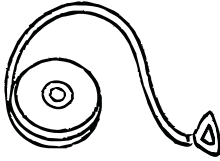



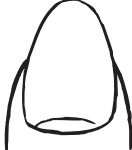

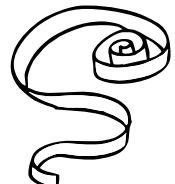
a b c d e f g h
i j k l m n o
p q r s t u v w
x y z

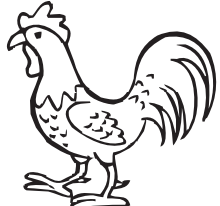
AGORA É A SUA VEZ. COPIE-AS NO QUADRO.

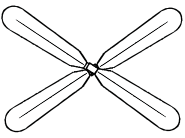
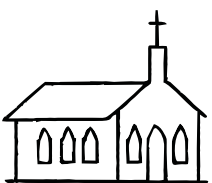
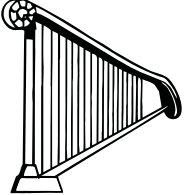
ESCREVA O NOME DE DUAS FRUTAS USANDO CORES
DIFERENTES. USE A MESMA COR PARA CIRCULAR
NO ALFABETO AS LETRAS QUE VOCÊ UTILIZOU.

a q u b A C S Z m X N O P C G V

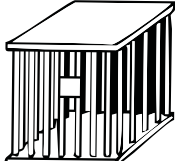
PINTE OS DESENHOS QUE TÊM A MESMA LETRA INICIAL INDICADA AO LADO.

b				
C				
d				
f				
g				
h				
i				

continua...

C b v H A B q A C U Z m O X

continuação

k



l

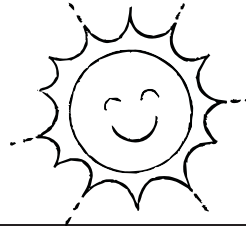
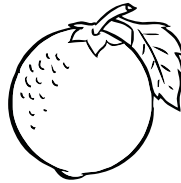

m

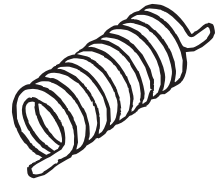
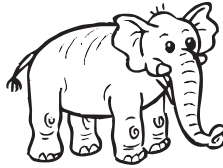
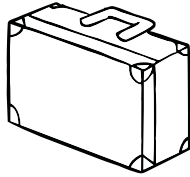

n

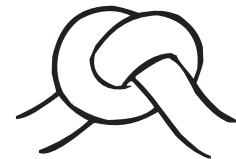

p

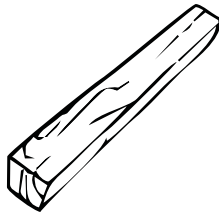

q





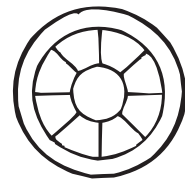
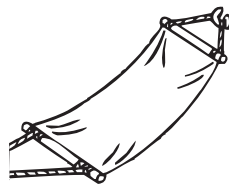
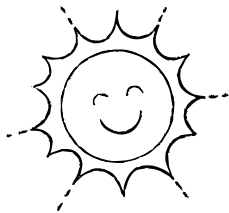





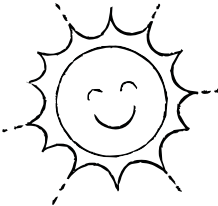

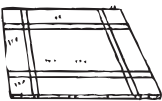

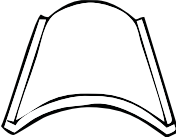



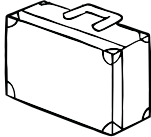

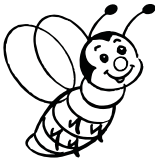
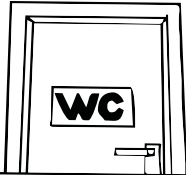

r

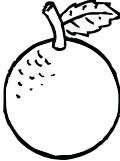
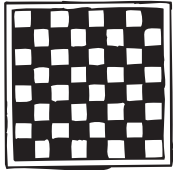

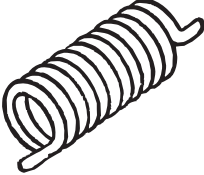
continua...

continuação

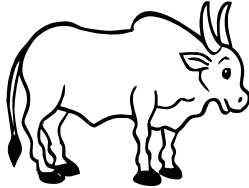
l				
t				
u				
w				
x				
y				
z				

a q u b A C S Z m X N O P C G V

ESCREVA UMA LETRA DO ALFABETO EM
CADA ESTRELINHA DA FADA.

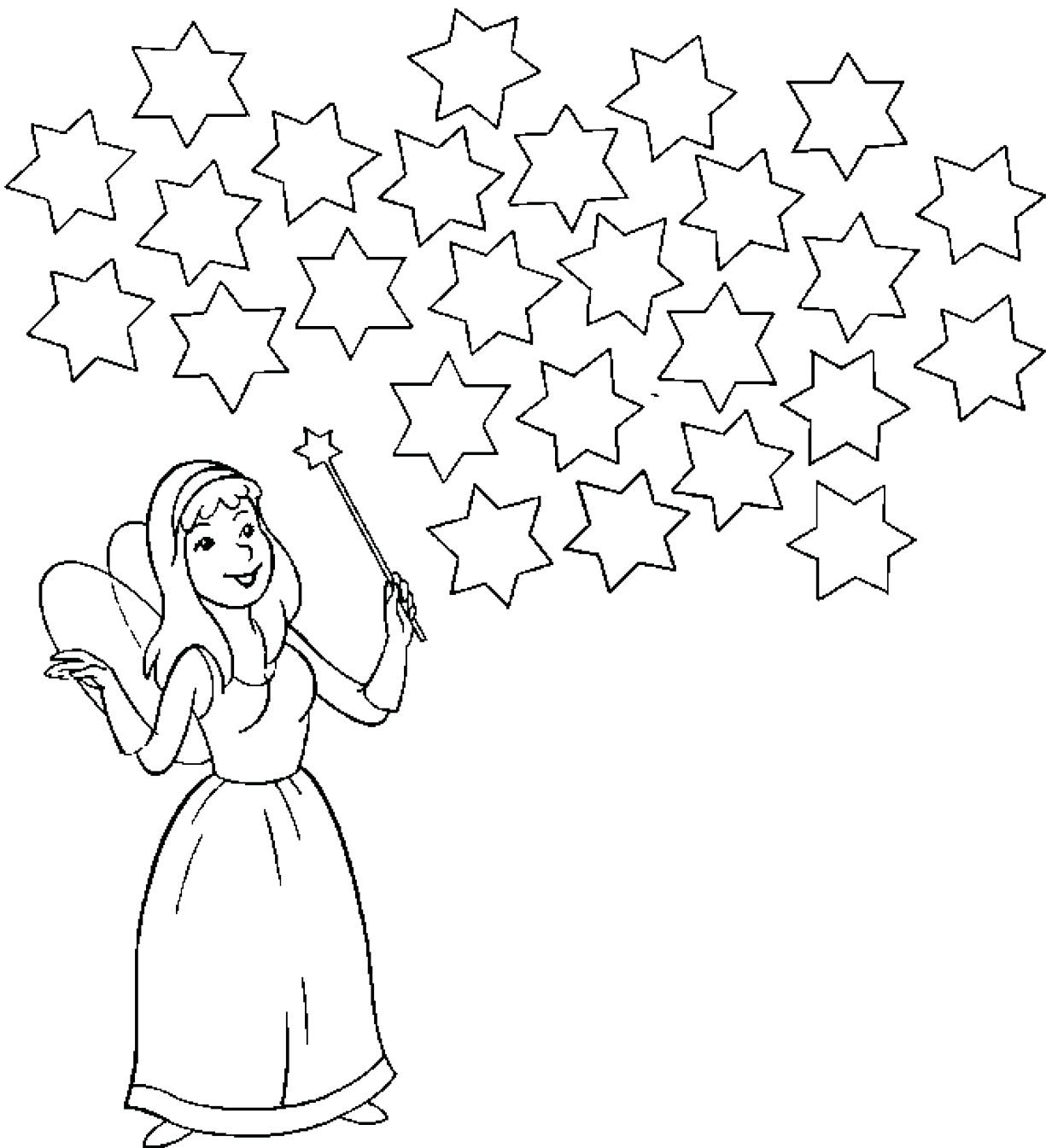

C b v H a B q A C u z m O X

RECORTE AS LETRAS DA CARTELA E COLE-AS NAS PÁGINAS
SEGUINTE OBEDECENDO A ORDEM ALFABÉTICA, DE ACORDO
COM A LETRA INICIAL DO DESENHO.

E	M	I	K	C
W	A	L	O	F
J	N	G	Y	R
T	P	X	B	V
D	U	Q	Z	S
		H		

a q u b A C S Z m X N O P C G V

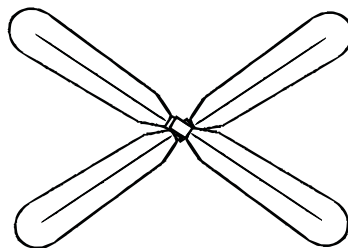
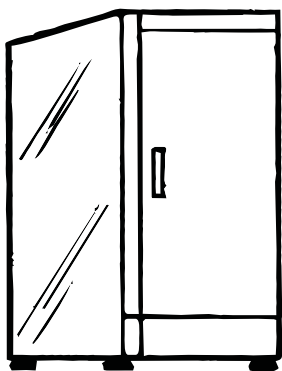
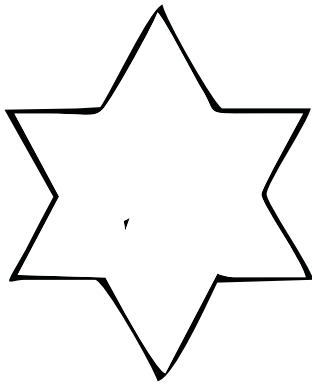
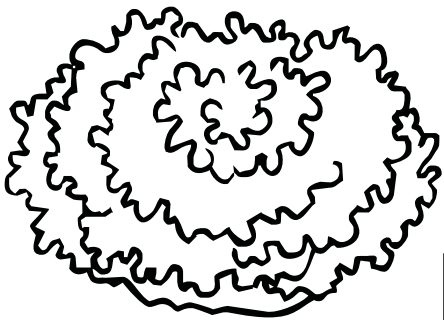

continua...

C b v H a B q A C u z m O X

continuação

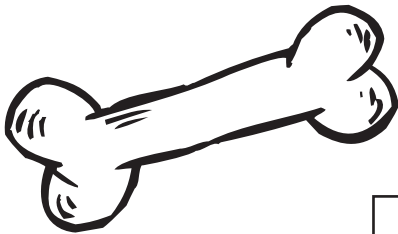
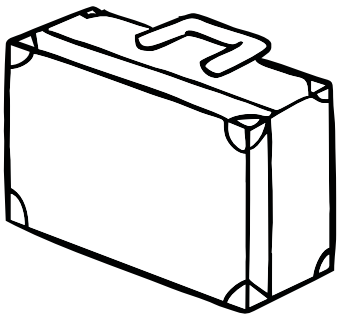
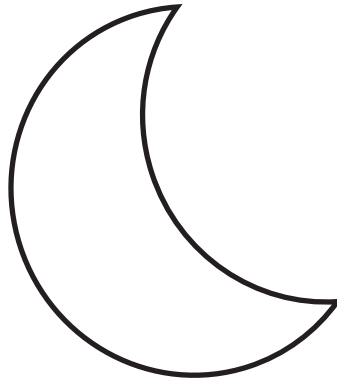
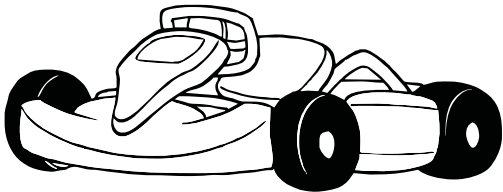
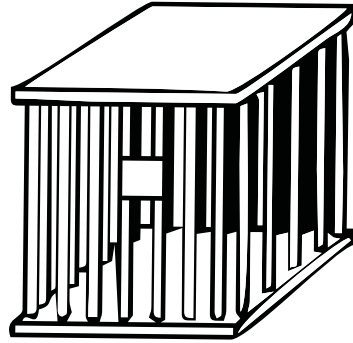
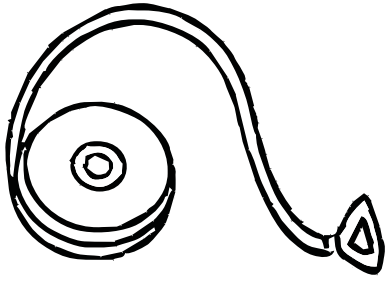

continua...

continuação

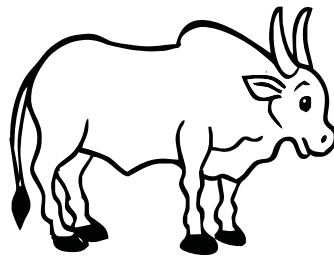
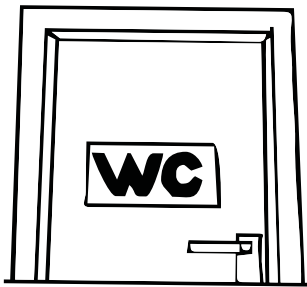
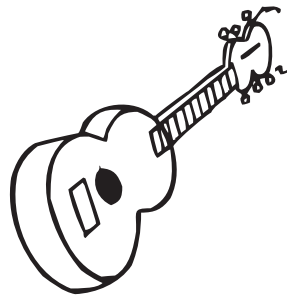
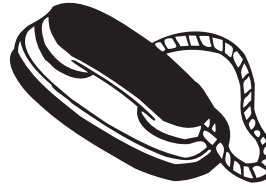
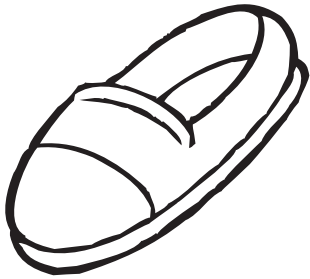
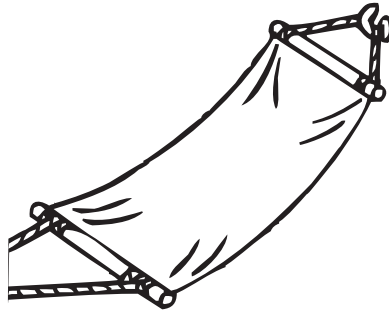
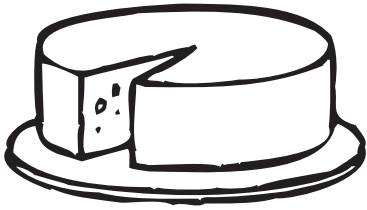

a q u b A C S Z m X N O P C G V

DITADO MUDO

ESCREVA A LETRA INICIAL DE CADA DESENHO.

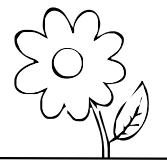

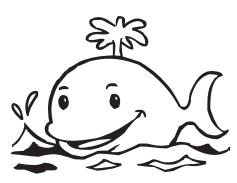
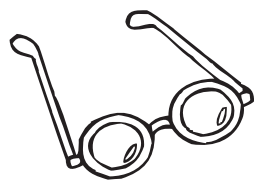
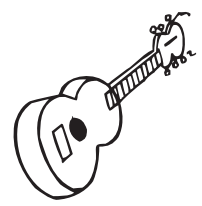

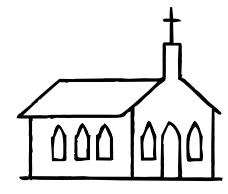
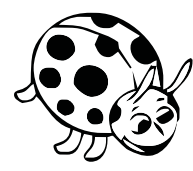
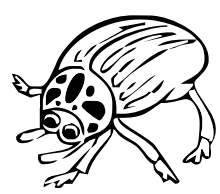

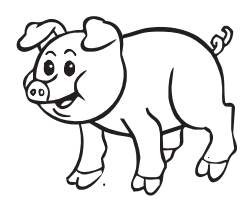
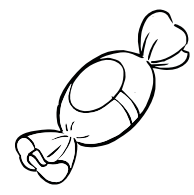
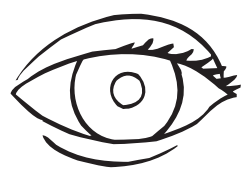
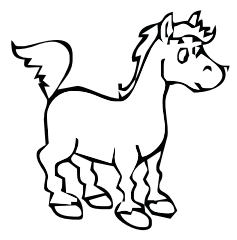

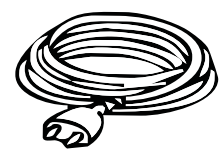





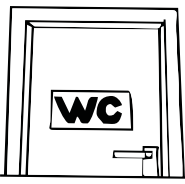
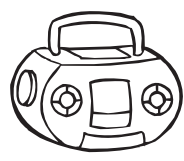

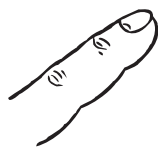
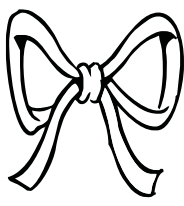



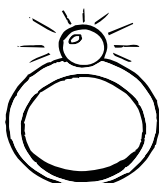

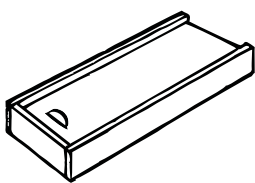
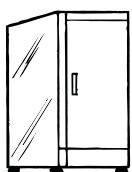
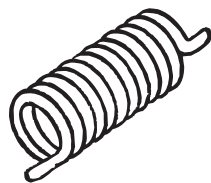
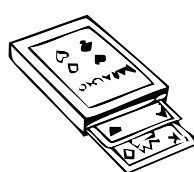

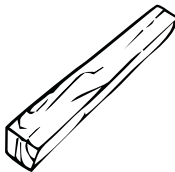
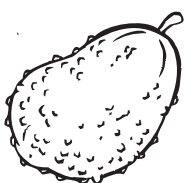

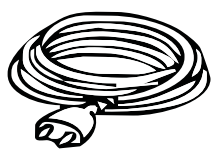
C b v h a B q A C u z m O X

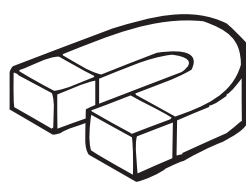
PINTE OS DESENHOS, RECORTE-OS E COLE,
OBEDECENDO A ORDEM ALFABÉTICA.

LIGUE OS DESENHOS QUE COMEÇAM COM A MESMA LETRA.

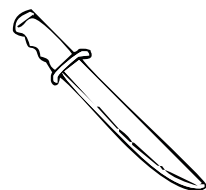
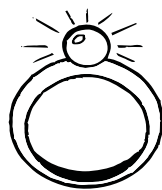
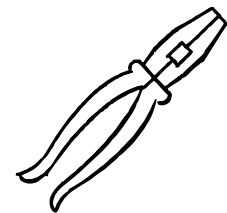
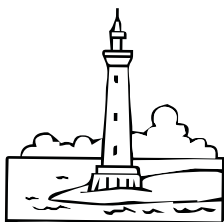
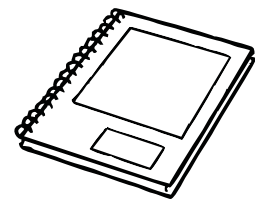
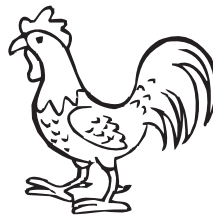
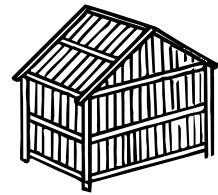
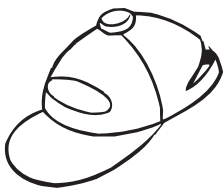
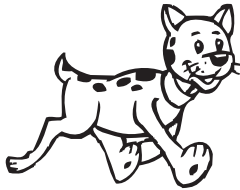
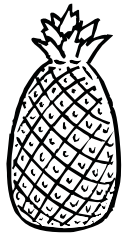

LIGUE OS DESENHOS QUE COMEÇAM COM A MESMA LETRA.

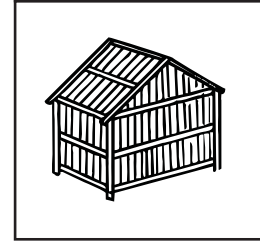
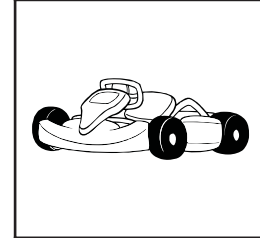
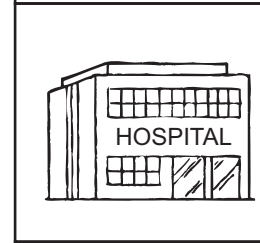
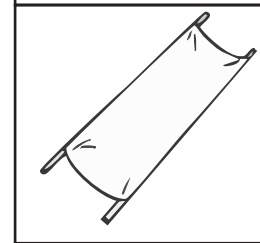
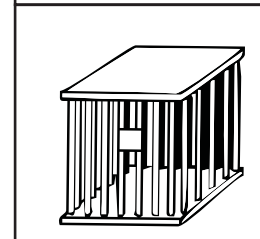
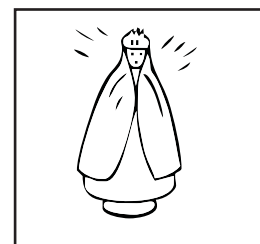
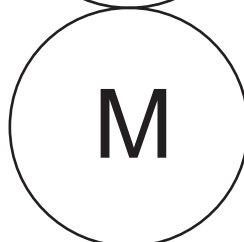
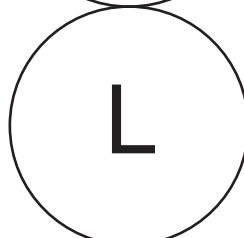
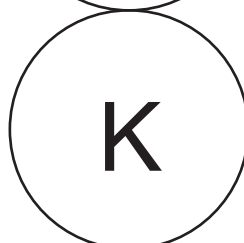
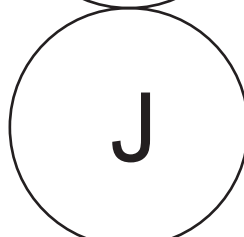
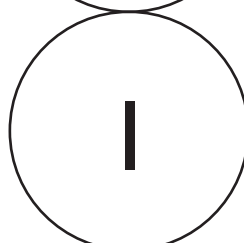
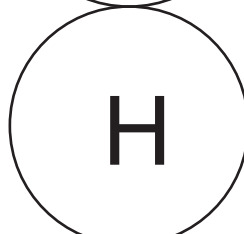
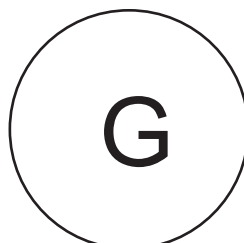
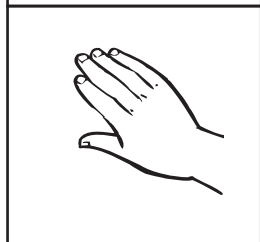
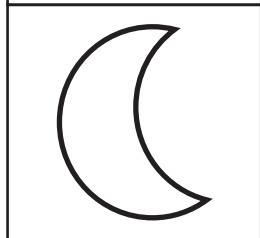
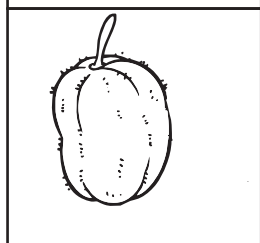
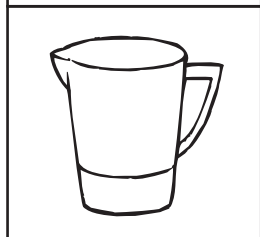
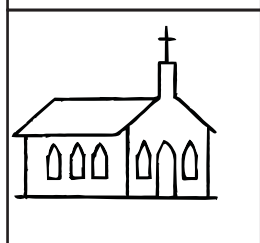
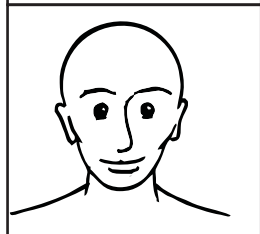
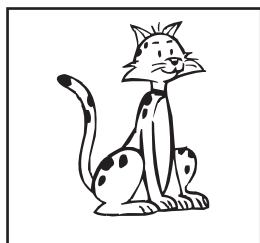

LIGUE CADA DESENHO A SUA LETRA INICIAL.

N

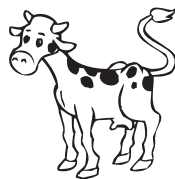
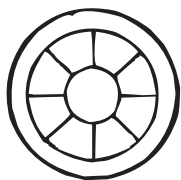

U

O



V

P

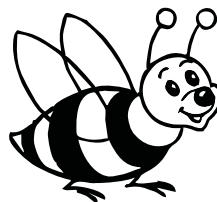

W

Q

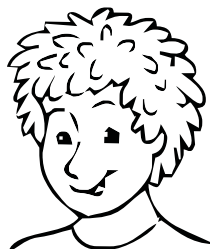

YAM

X

R



S

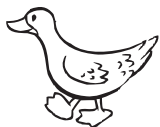



Y

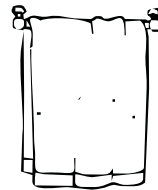
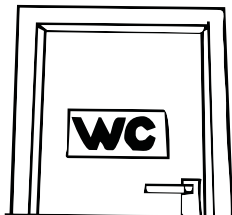
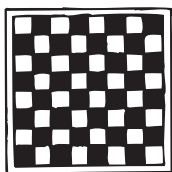

T

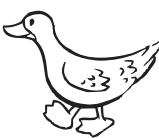

Z

NAS PALAVRAS ABAIXO PINTE A LETRA
INDICADA EM CADA QUADRO.

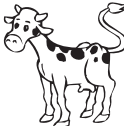
 B	 P	 D	 T
BOLA	PATO	DAMA	TACO
CABO	CAPA	MODA	MATO
CABELO	CAPOTE	CADEIRA	BOTÃO

 F	 V	 G	 J
FACA	VACA	GATO	JACA
COIFA	LUVA	MAGO	CAJU
MOFO	LEVADO	MÁGICO	CAJUADA

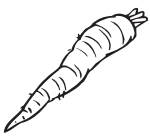
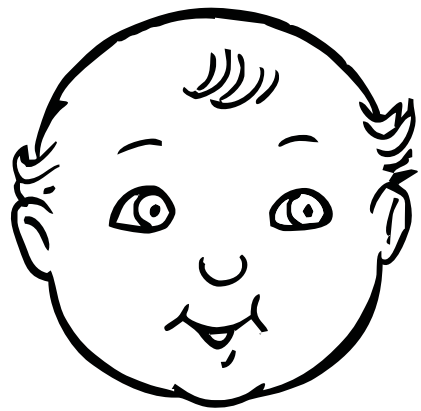
 M	 N	
MÃO	NABO	
CAMA	BONÉ	
TOMADA	BONECA	

NUMERE OS DESENHOS DE ACORDO COM A LETRA INICIAL.

a 1 b 2 c 3 d 4 e 5 f 6 g 7 h 8 i 9 j 10

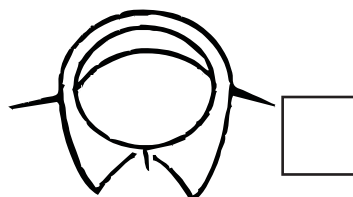
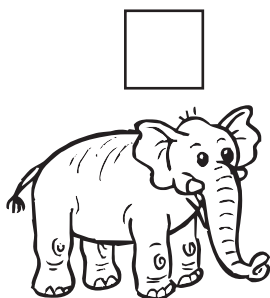
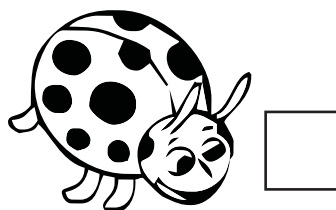
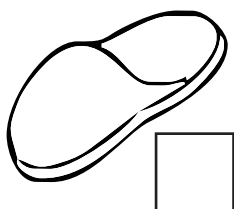
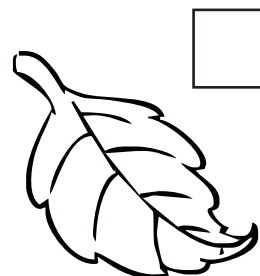
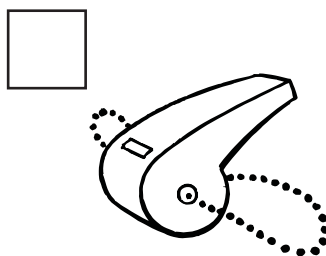
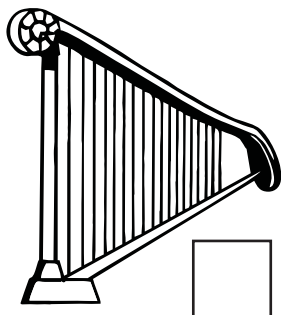
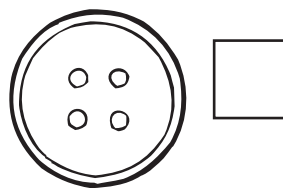
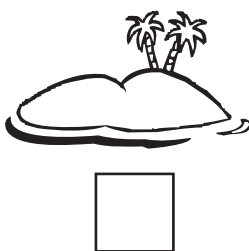
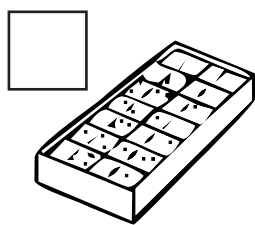

a q u b A C S Z m X N O p c g V

VAMOS ESCREVER AS PALAVRAS
EM ORDEM ALFABÉTICA?

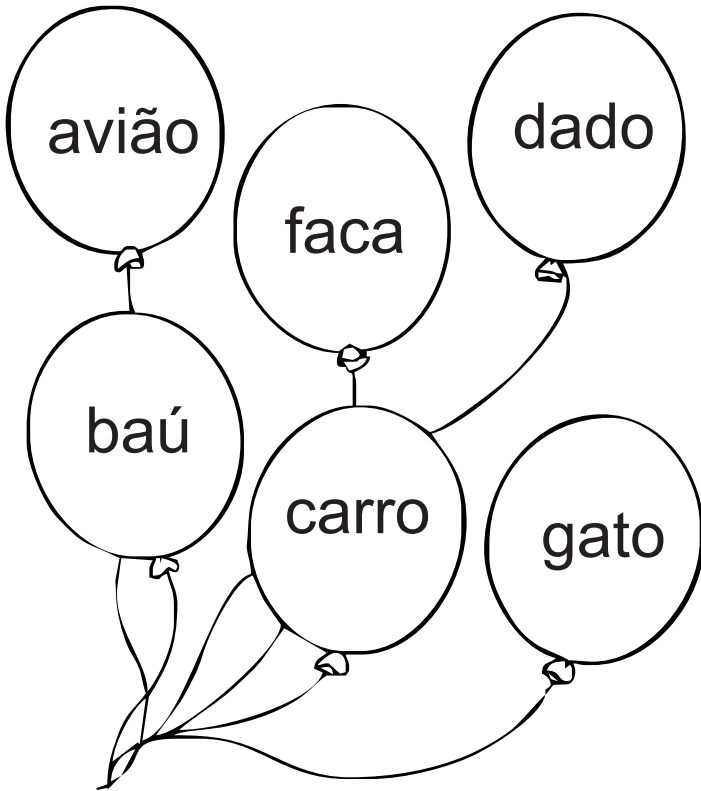

COMPLETE AS LETRAS QUE
FALTAM NO ALFABETO.

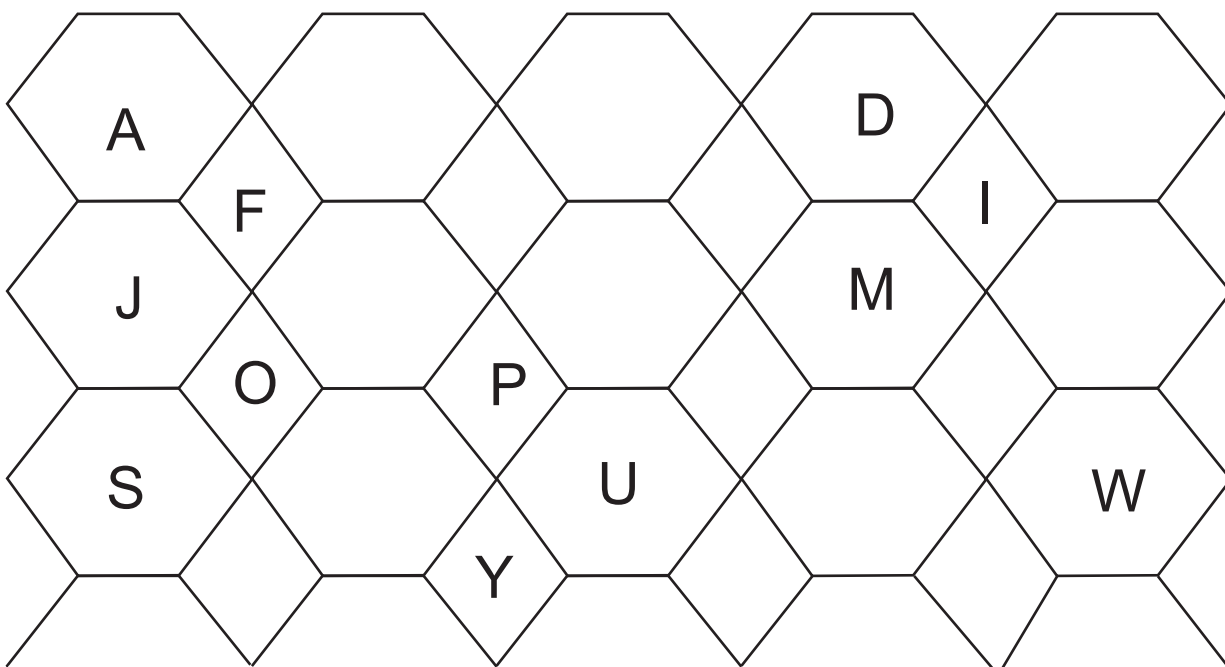

C b v h a B q A C u z m O X

LIGUE O DESENHO À LETRA INICIAL.



X

F



B

Z

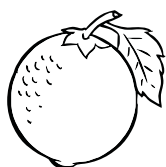

Y

M



S

P

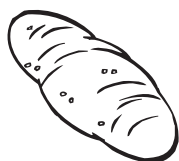

L

R



T

C

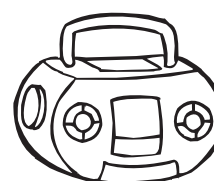

a q u b A C S Z m X N O P C G V

PINTE DE VERDE AS VOGAIS E DE VERMELHO AS CONSOANTES.

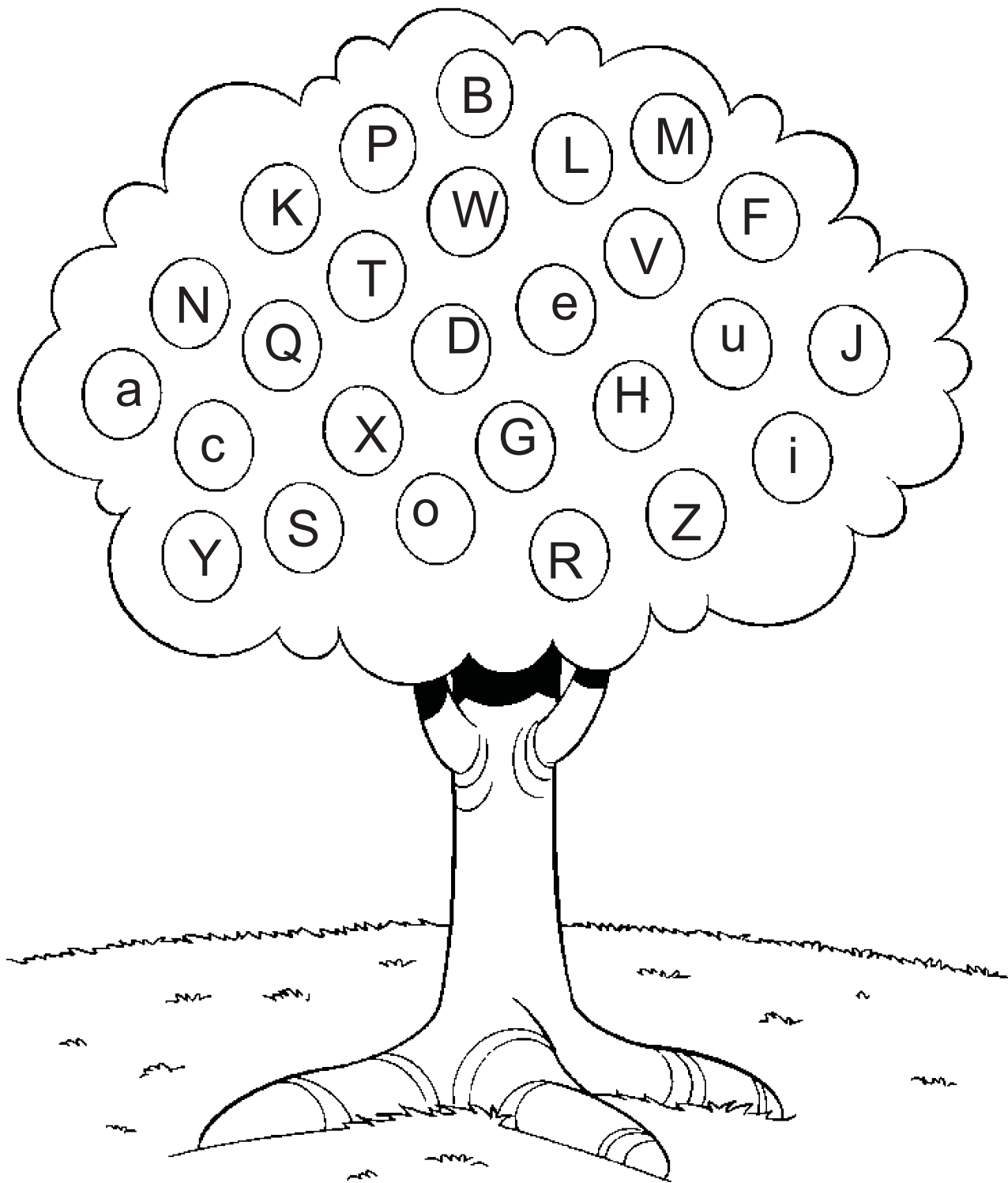

C b v H a B q A C u z m O X

RECORTE LETRAS DE JORNAL / REVISTA E
COLE-AS DE ACORDO COM O QUE SE PEDE.

VOGAIS

CONSOANTES

COMPLETE O QUADRO ABAIXO:

A- _____	-D- _____		
F- _____	-H- _____	-K- _____	
_____	-M- _____	_____	-Q- _____
_____	-T- _____	_____	
W- _____	-Y- _____		

CIRCULE AS VOGAIS DE AZUL E AS CONSOANTES DE AMARELO.

ESCREVA AS LETRAS SEPARANDO-AS.

VOGAIS	CONSOANTES

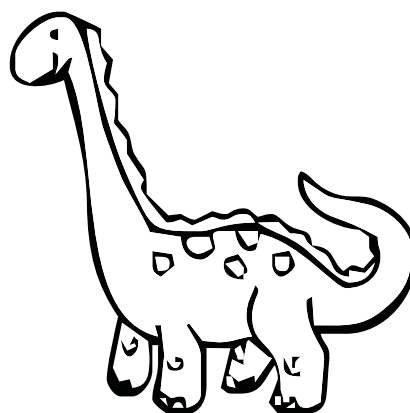

a q u b A C S z m X N O p c G V

CRUZADINHA

NA HORIZONTAL, AS PALAVRAS INICIAM-SE COM CONSOANTES, E NA VERTICAL COM VOGAIS.

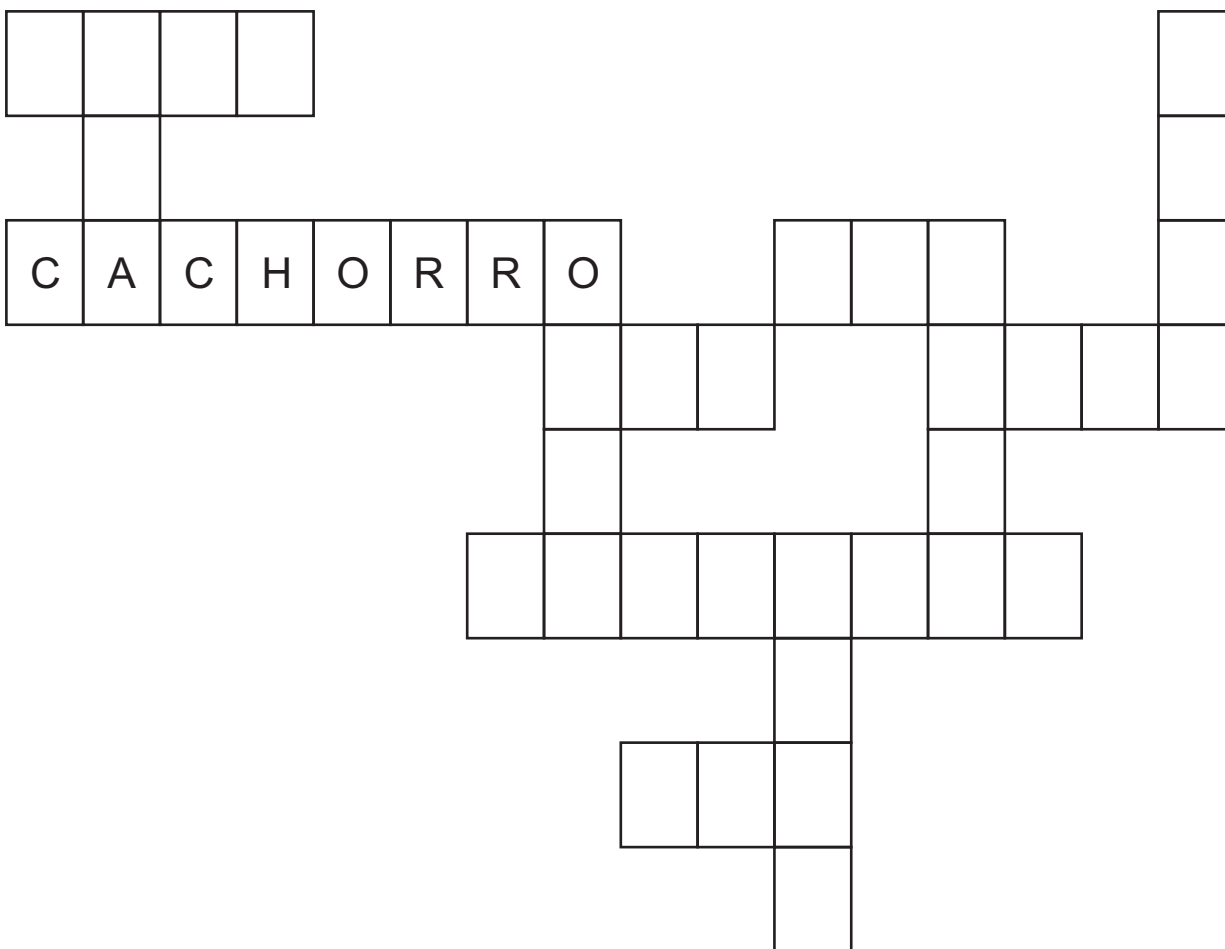

OSSO	ÁGUA	LUA	IOIÔ
CACHORRO	HOSPITAL	ZEBU	BOI
UNHA	SOL	EMA	GOLA

C b v H a B q A C u z m O X

a q u b A C S z m X N O p c G V

PINTE AS VOGAIS DE VERDE E AS
CONSOANTES DE VERMELHO.

A N S
B Q W
F C L Y
C L H U Z
J D T O X
M G V
E I P R

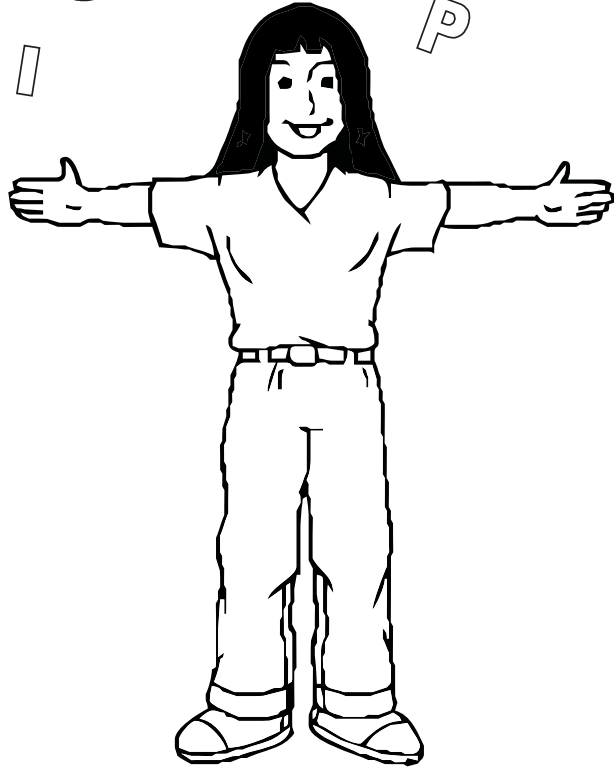

C b v H a B q A C u z m O X

RECORTE E COLE AS PALAVRAS. AS PALAVRAS INICIADAS COM AS LETRAS IGUAIS SERÃO VIZINHAS.

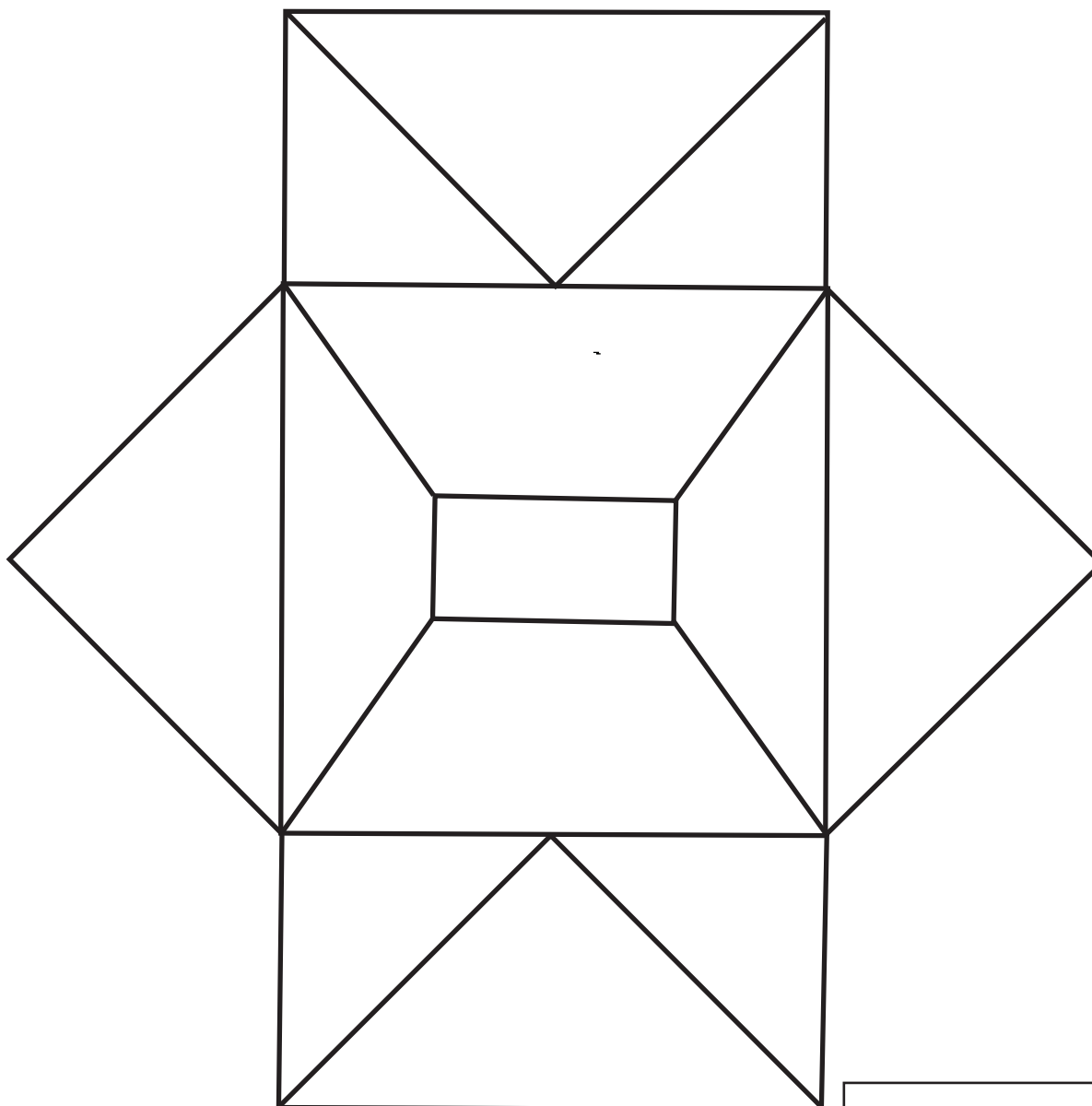

			URSO
ÁGUA	UNHA	ILHA	ESTRELA
APITO	EMA	OSSO	UVA
IDADE	ÓCULOS	ESPADA	AZUL

a q u b A C S Z m X N O P C G V
p
c
v
o
g
s
a
s
u
D
q
N
G
c
h
C b v H a B q A C u z m O X

VOGAIS FUJONAS

COMPLETE NOS ESPAÇOS,
AS VOGAIS QUE FUGIRAM.



F _ C _



G _ T _



H _ RP _

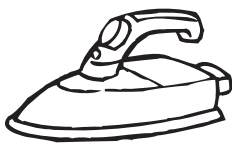

F _ RR _

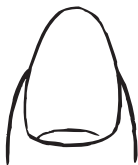

_ NH _

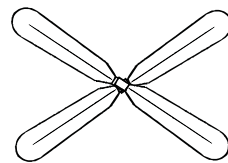

H _ L _ C _



F _ G _



G _ R _ F _



H _ N _



F _ G _



G _ RR _

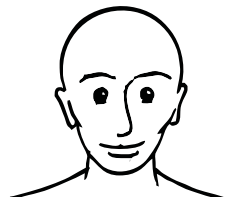

H _ M _ M



F _ M _ Ç _

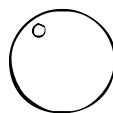

G _ D _



H _ M _ N _

a q u b A C S Z m X N O P C G V

ESCREVA UMA VOGAL EM CADA VAGÃO DO TRENZINHO. DEPOIS, ESCREVA DUAS PALAVRAS INICIADAS POR ELAS.

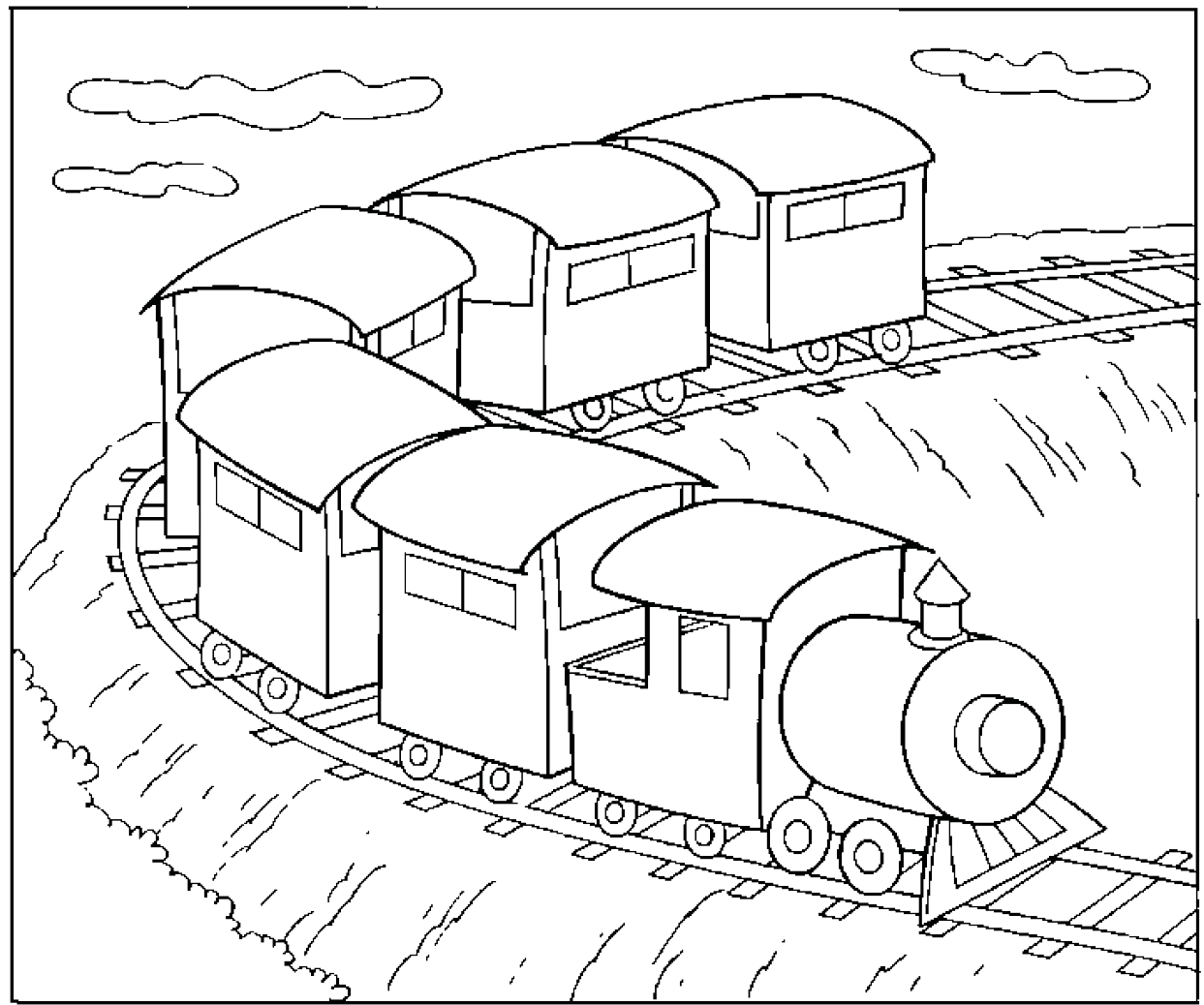

C b v H a B q A C u z m O X

a q u b A C S Z m X N O P C G V

ESCREVA A VOGAL QUE ESTÁ NO INÍCIO DO NOME DE CADA DESENHO.

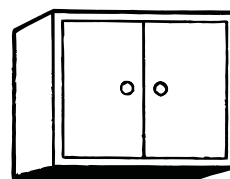
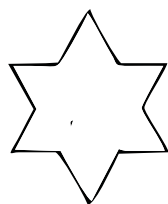
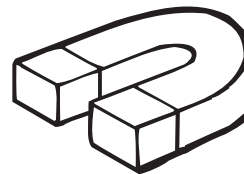
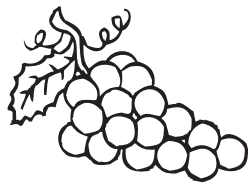
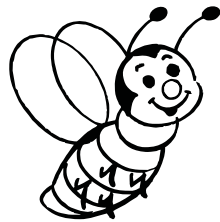

C b v H a B q A C u z m O X

a q u b A C S Z m X N O P C G V

ESCREVA A VOGAL QUE ESTÁ NO FINAL DO NOME DE CADA DESENHO.

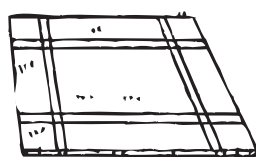
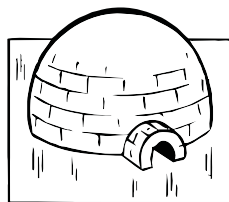
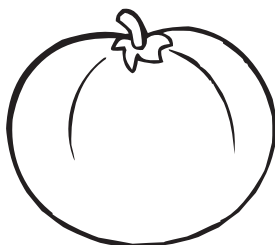
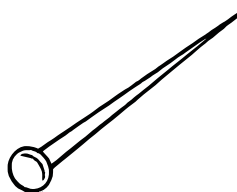
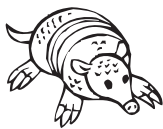

C b v H a B q A C u z m O X

a q u b A C S Z m X N O P C G V

PINTE OS ANIMAIS QUE TEM O NOME INICIADO POR VOGAIS.

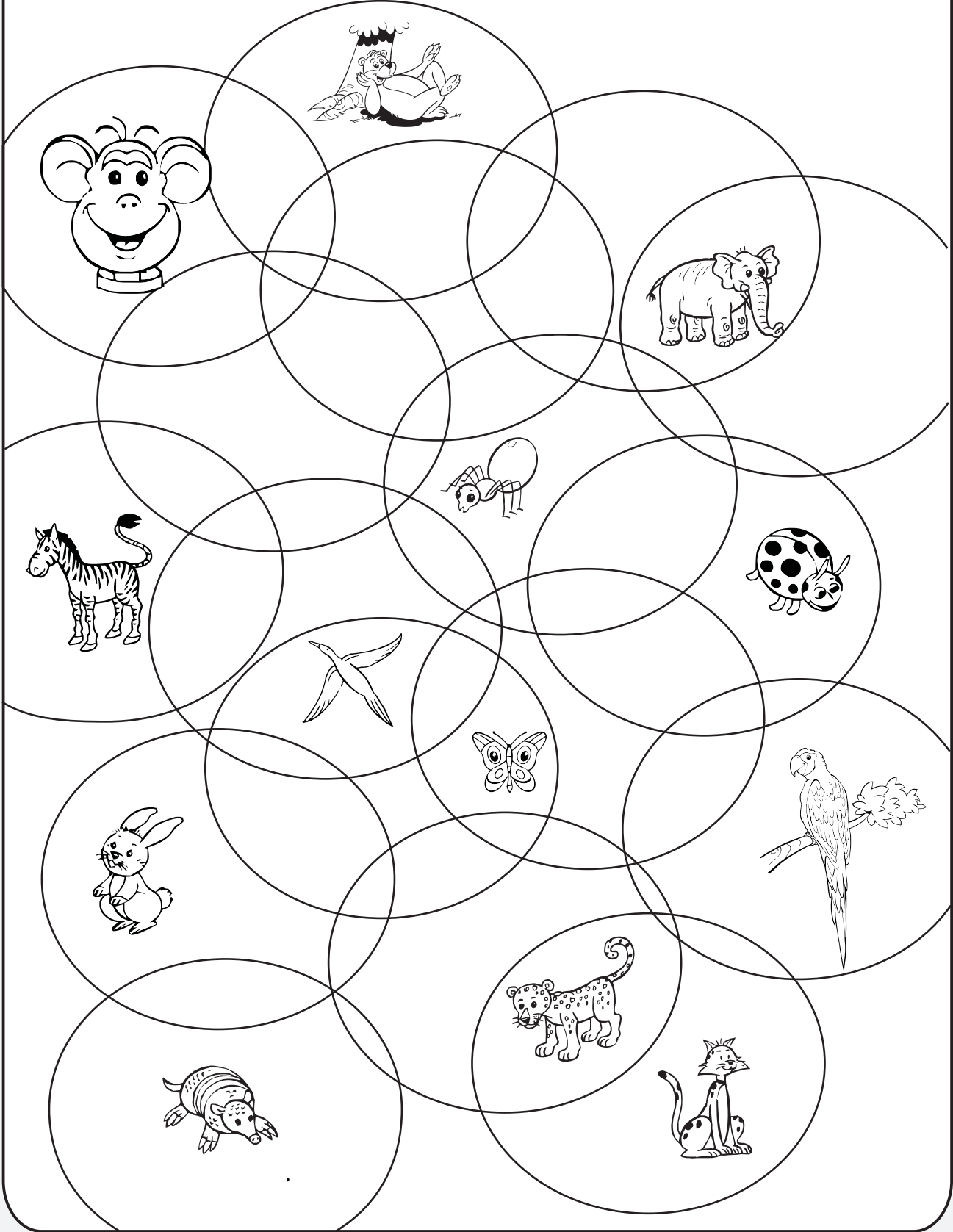

C b v H A B q A C u z m O X

QUEBRA-CABEÇA DAS VOGAIS

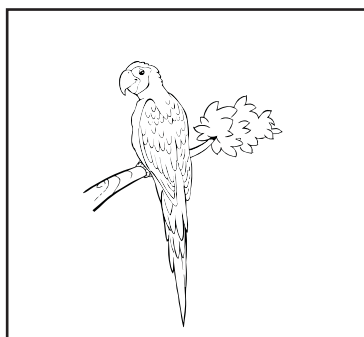

E

MA

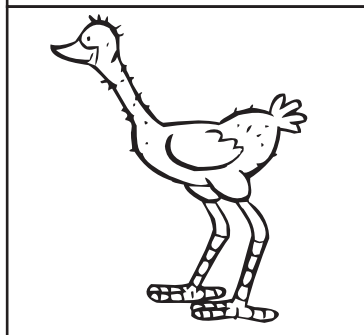

ON

ÇA

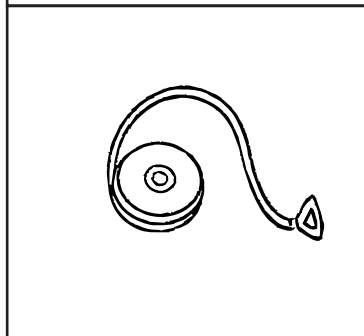

U

VA

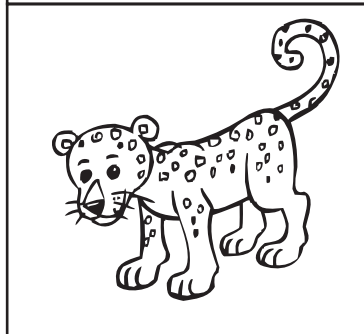

IO

IÔ

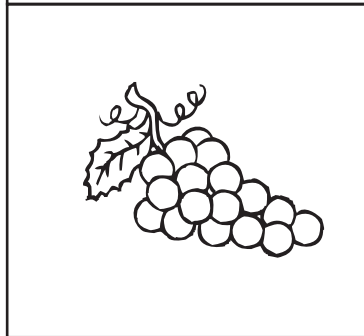







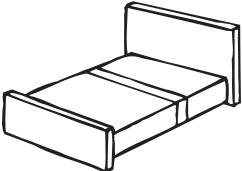
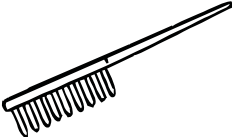

A

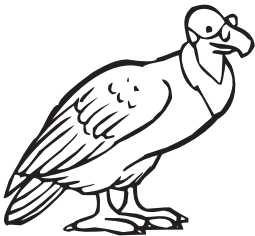
RA

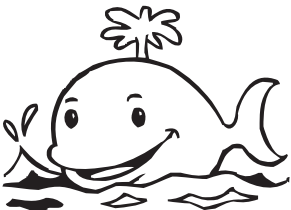
RA

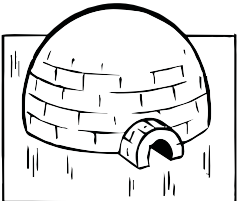
COMPLETE AS PALAVRAS ABAIXO
COM AS VOGAIS. DEPOIS, COPIE CADA
UMA SEPARANDO-AS POR LETRAS.

		
C _ M _	P _ NT _	S _ R _ _ _
		
_ R _ B _	C _ P _	_ RS _
		
B _ L _ _ _	P _ T _ C _	T _ T _
		
_ GL _	F _ C _	D _ C _

OBSERVE O QUADRO AO LADO E ESCREVA
A LETRA INICIAL DO NOME DE CADA DESENHO.



ARARA

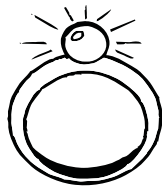

ANEL

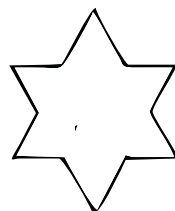
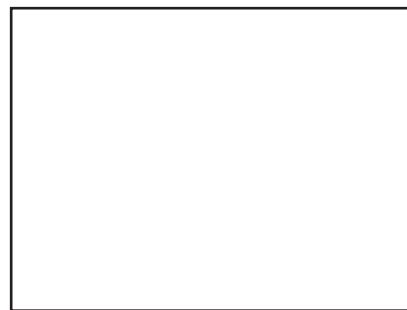

ESTRELA

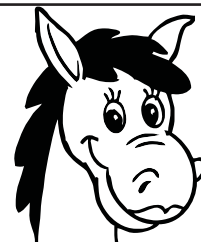

ÉGUA

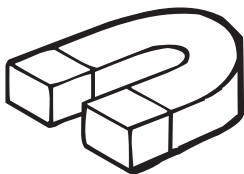

ÍMÃ

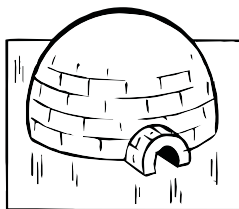

IGLU

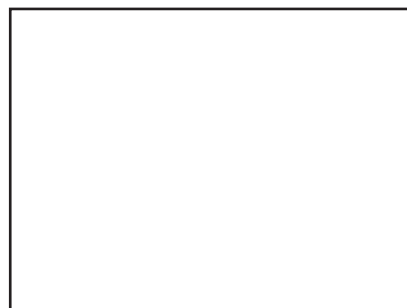

OSSO



OVO

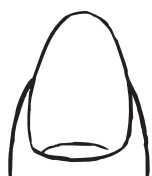

UNHA



URSO



a q u b A C S Z m X N O p c G V

AJUDE O ASTRONAUTA A CHEGAR ATÉ O SEU FOGUETE ESCRIVENDO AS CONSOANTES MAIÚSCULAS DENTRO DOS CÍRCULOS.

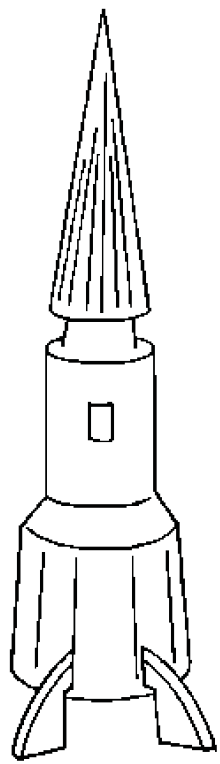
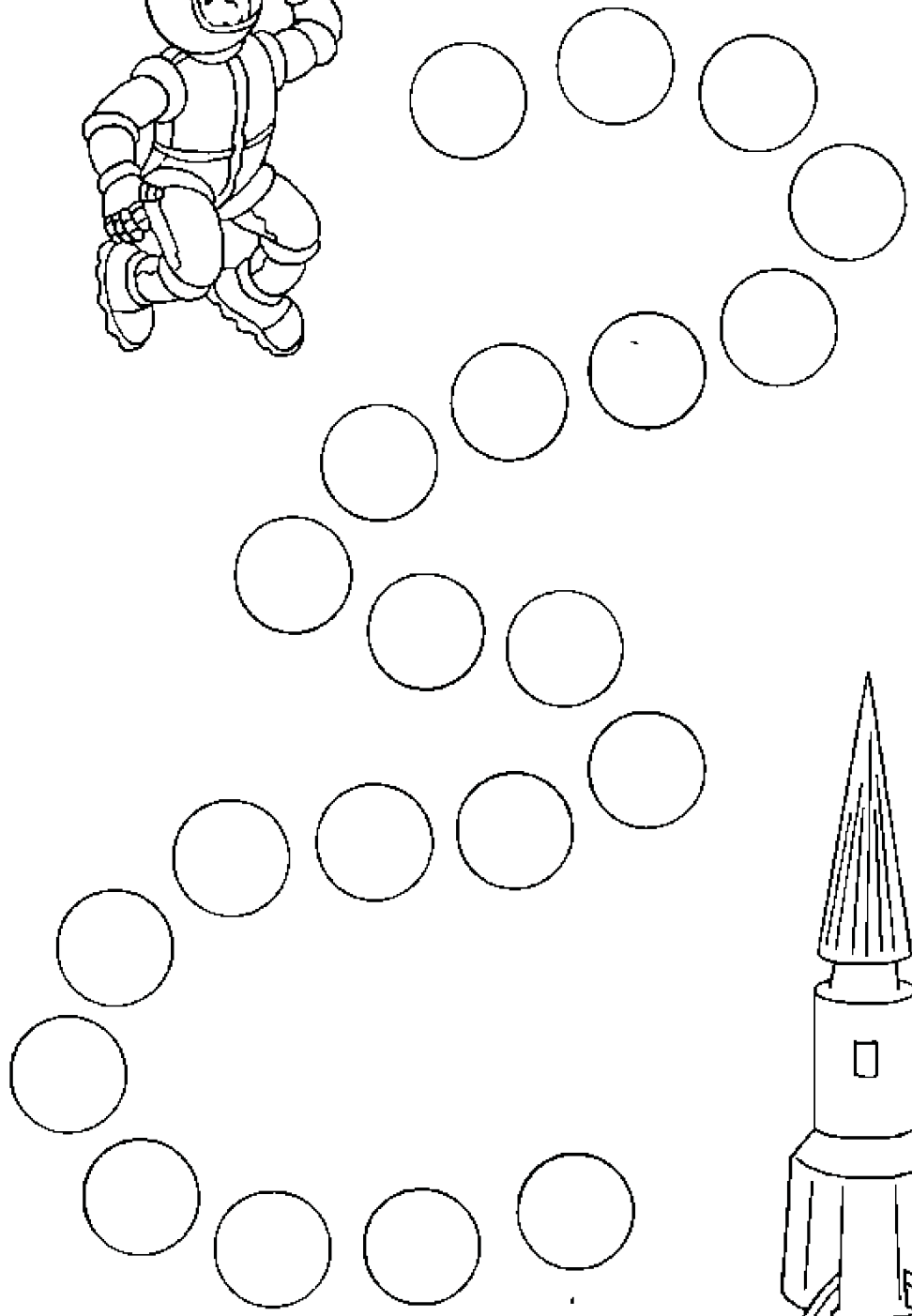
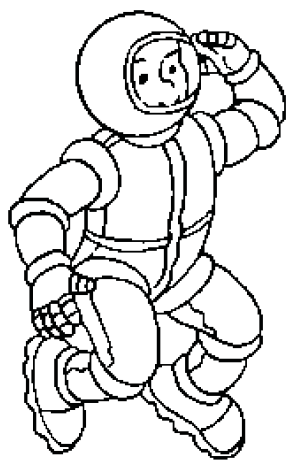

C b v H a B q A C u z m O X

a q u b A C S Z m X N O P C G V

PINTE SOMENTE OS DESENHOS, CUJOS NOMES SE INICIAM POR CONSOANTES.

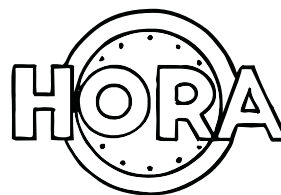
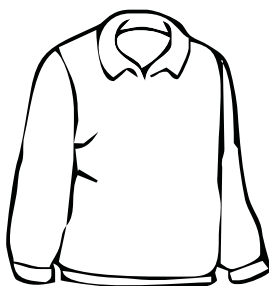
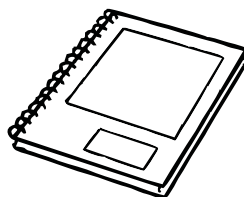
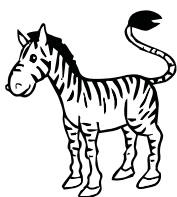
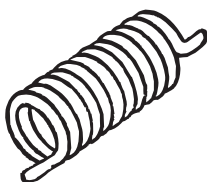
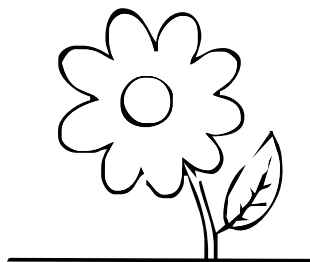
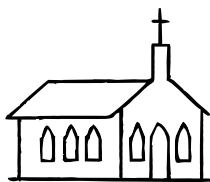
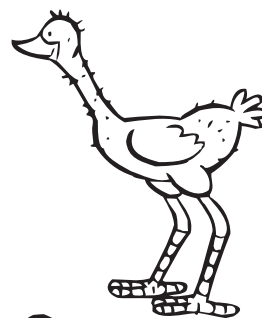
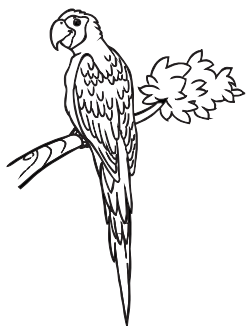
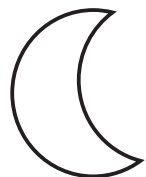

C b v H A B q A C u z m O X

CRIE UM DESENHO PARA CADA
CONSOANTE DO ALFABETO.

B	C	D	F	
G	H	J	K	
L	M	N	P	
Q	R	S	T	
V	W	X	Y	Z

COMPLETE COM CONSOANTES E ESCREVA AS PALAVRAS.

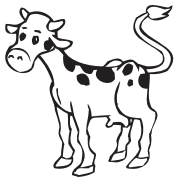

__A__A

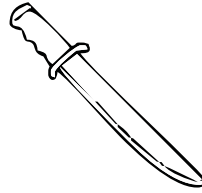

__A__A

__A__O

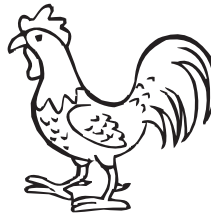

__A__O



__A__O

__A__O



__O__O



__O__O

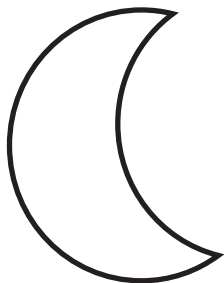
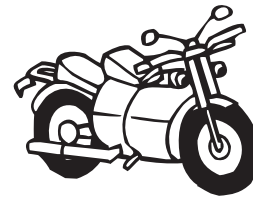

__UA



__UA

a q u b A C S Z m X N O P C G V

OBSERVE O QUADRO COM DESENHOS.



AGORA, ESCREVA A LETRA INICIAL E O NOME DOS DESENHOS COMEÇADOS POR CONSOANTES.

<input type="text"/>	_____	<input type="text"/>	_____
<input type="text"/>	_____	<input type="text"/>	_____
<input type="text"/>	_____	<input type="text"/>	_____
<input type="text"/>	_____	<input type="text"/>	_____
<input type="text"/>	_____	<input type="text"/>	_____

C b v H A B q A C u z m O X

MUDE A LETRA INICIAL PARA
ESCREVER OUTRA PALAVRA.

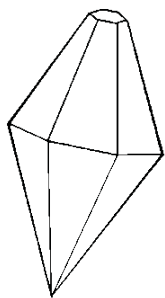

BALÃO
__ALÃO
__ALÃO



GATO
__ATO
__ATO



FOCA
__OCA
__OCA



GELO
__ELO
__ELO

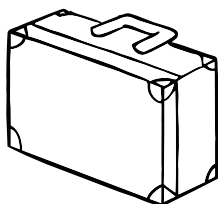

MALA
__ALA
__ALA



SAPO
__APO
__APO

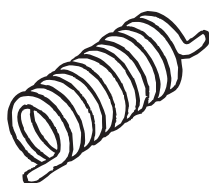

MOLA
__OLA
__OLA

a q u b A C S Z m X N O P C G V

FORME PALAVRAS QUE INICIEM COM AS LETRAS INDICADAS NOS BALÕES.

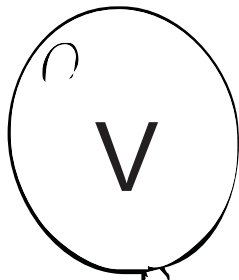

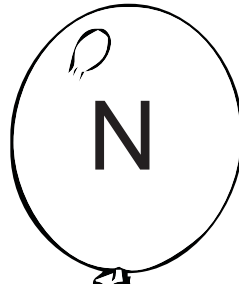

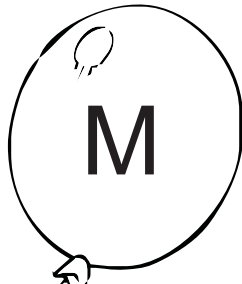

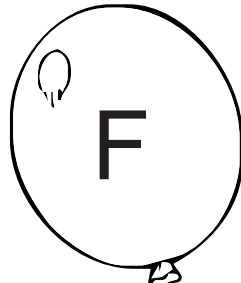



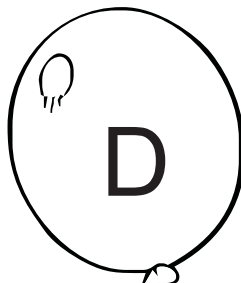
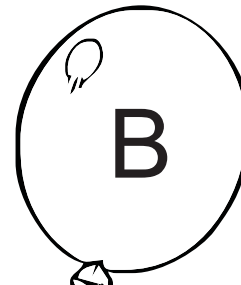

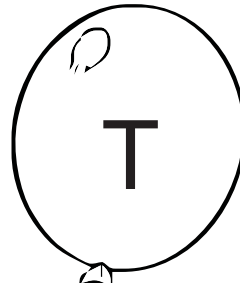

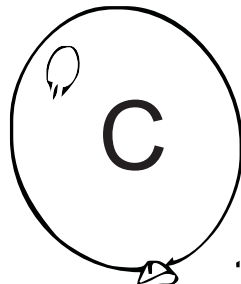

C b v H a B q A C u z m O X

a q u b A C S z m X N O p c G V

COPIE DA CANÇÃO UMA PALAVRA QUE TENHA
A LETRA INDICADA NOS BALÕES ABAIXO.

O BALÃO VAI SUBINDO
VAI CAINDO A GAROA.
O CÉU É TÃO LINDO,
A NOITE É TÃO BOA.
SÃO JOÃO, SÃO JOÃO
ACENDE A FOGUEIRA
DO MEU CORAÇÃO.

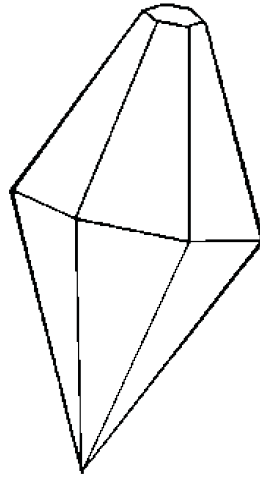

(CD *As mais Belas Cantigas de Roda*. Ciranda Cultural, pág. 85)

A _____

B _____

C _____

D _____

E _____

F _____

G _____

I _____

J _____

L _____

M _____

N _____

C b v H a B q A C u z m O X

CAÇA-PALAVRAS

AS PALAVRAS ESCONDEM-SE ENTRE AS LETRAS.
QUAIS SÃO ELAS? COPIE-AS NO QUADRO ABAIXO.

Z	C	O	L	A	X	F	O	G	O
B	O	I	H	W	K	O	H	X	W
O	C	Y	D	I	A	C	Y	Z	M
L	O	K	E	B	G	A	T	O	N
A	Z	D	D	C	A	J	A	C	A
K	Y	G	O	F	L	A	L	U	A
H	O	M	E	M	O	B	O	X	K
O	W	M	O	T	O	U	J	Y	P
R	I	Ã	Z	N	O	T	A	S	K
A	A	O	W	Ó	A	I	Z	X	R

B_____	B_____	C_____	C_____
D_____	D_____	F_____	F_____
G_____	G_____	H_____	H_____
J_____	J_____	L_____	L_____
M_____	M_____	N_____	N_____

a d u b A c s z m x N O p c G V

CONTE AS LETRAS E ESCREVA AS PALAVRAS NO ESPAÇO CORRESPONDENTE.

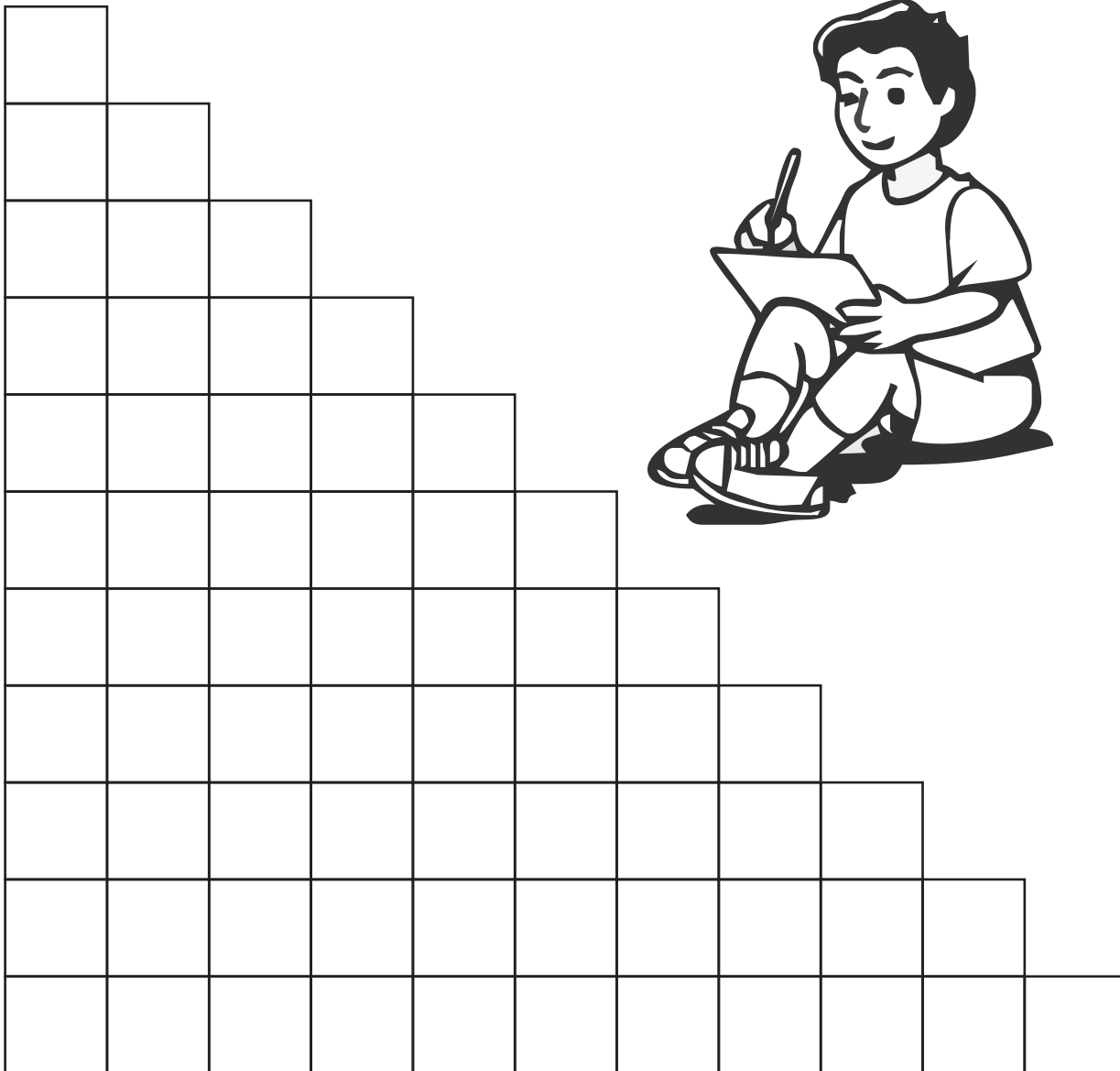

p
c
c
v
o
q
s
a
s
u
D
q
N
G
C
h

g
a
s
u
q
h
z
s
p
r
D
A
m
O
V
P
N

CASA	HORTALIÇA	A	
INTERNAUTA	JAGUATIRICA	ESCADA	BOI
FORMIGA	AI	CARRO	GOIABA

C b v H a B q A C u z m O X

TROCA LETRAS

MUDE A LETRA INICIAL PARA
ESCREVER OUTRA PALAVRA.

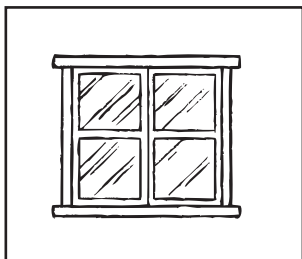

JANELA



__ ANELA

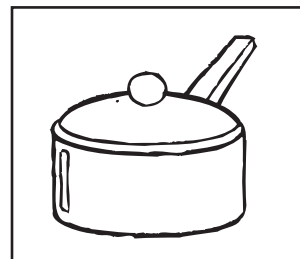

__ ANELA

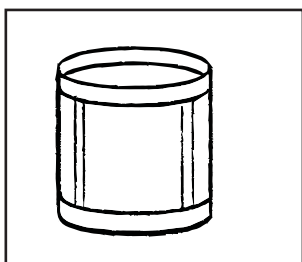

LATA



__ ATA

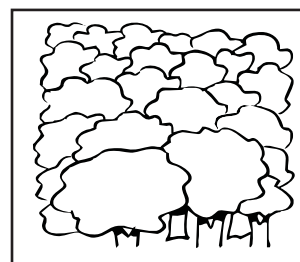

__ ATA

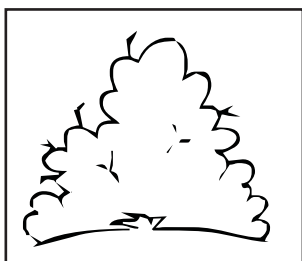

MATO

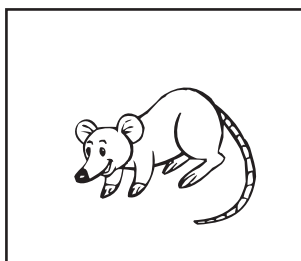

__ ATO

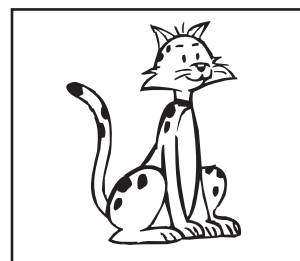

__ ATO

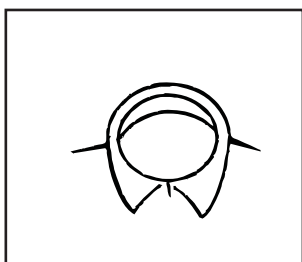

GOLA

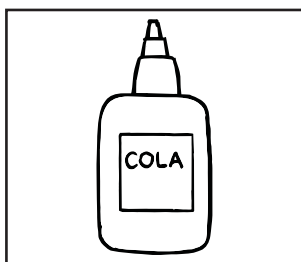

__ OLA

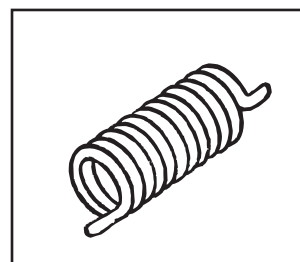

__ OLA

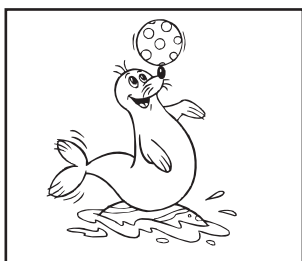

FOCA

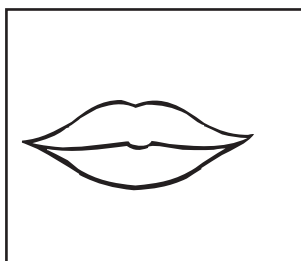

__ OCA

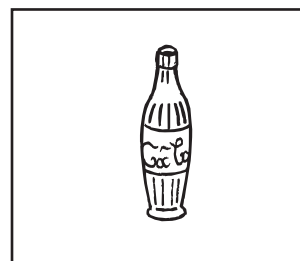

__ OCA

COMPLETE COM A LETRA QUE FALTA E,
DEPOIS COPIE A PALAVRA.



__RVORE _____



__ONECA _____



__ARRO _____



__OCE _____



__SCOLA _____



__EIJÃO _____

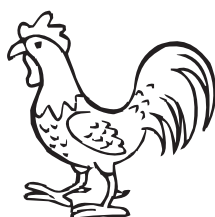

__ALO _____



__ORTELÃ _____

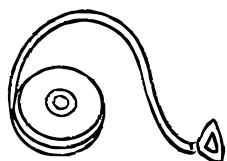

__OIÔ _____

continua...

continuação

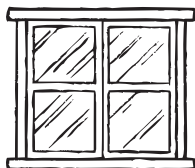

__ ANELA _____



__ IBON _____

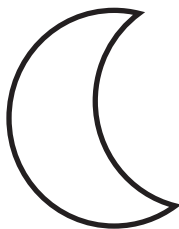

__ UA _____



__ OLA _____

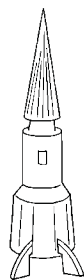

__ AVE _____



__ CA _____

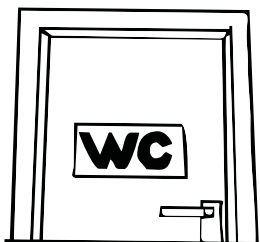

__ ORTA _____



__ UATI _____



__ AMO _____

continua...

continuação



___ALADA _____

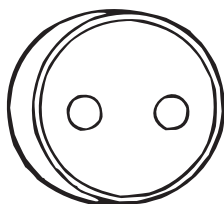

___OMADA _____

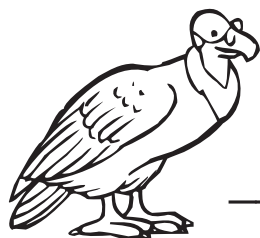

___RUBU _____

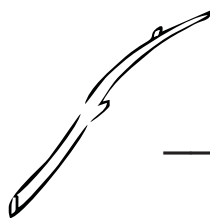

___ARA _____



___WW. _____

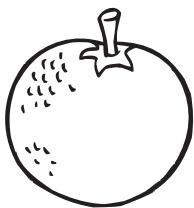

ME__ERICA _____

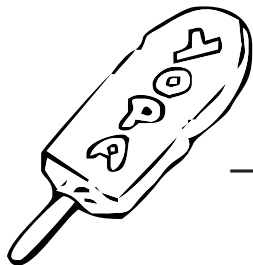

___OPA _____

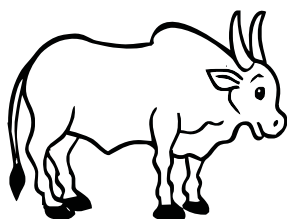

___EBU _____

QUAIS PALAVRAS PODEMOS FORMAR COM ESSAS LETRAS?
 PINTE OS DESENHOS QUE INDICAM AS PALAVRAS FORMADAS.

C	L	
B	T	
A	O	
A	E	

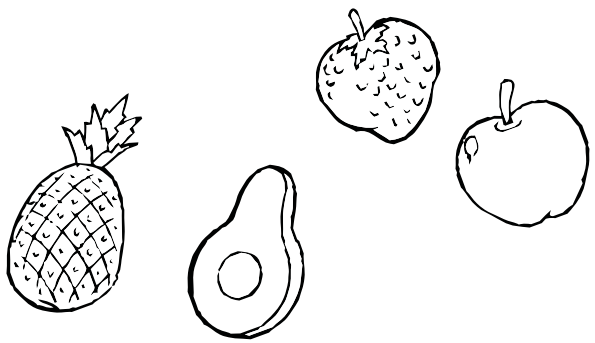
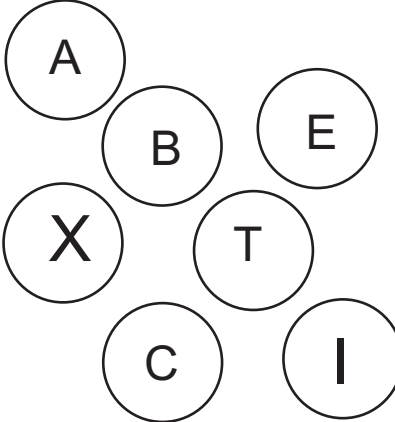
	
--	--

B	C	
N	O	
E	L	
T	A	

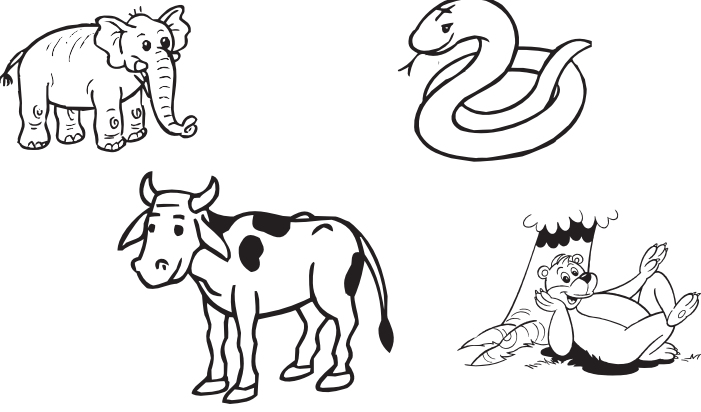
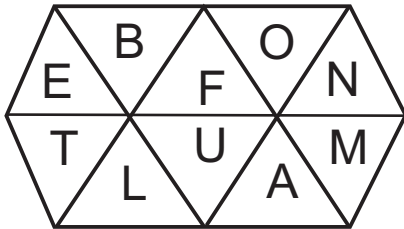
	
---	---

a q u b A C S Z m X N O P C G V

ESCREVA DUAS PALAVRAS QUE COMECEM COM A PRIMEIRA LETRA DOS NOMES DOS DESENHOS.

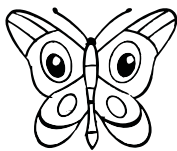

_____ e _____

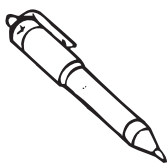

_____ e _____



_____ e _____



_____ e _____



_____ e _____

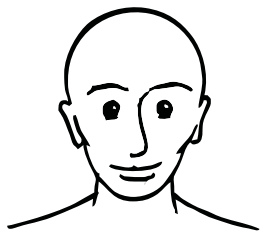

_____ e _____

C b v H a B q A C u z m O X

a q u b A C S Z m X N O P C G V

QUAIS NOMES VOCÊ CONSEGUE FORMAR COM AS LETRAS DO QUADRO? APÓS FORMADOS, PINTE-OS.

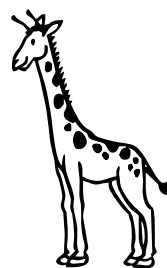
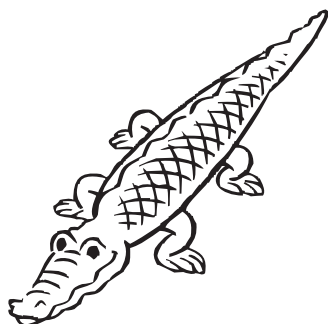
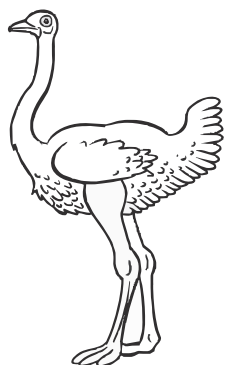
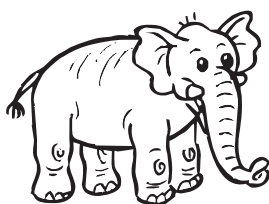
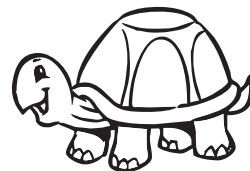

L	Z	A	C
		O	
S	R	E	U
V		T	B

C b v H a B q A C u z m O X

ESCREVA UMA PALAVRA QUE INICIE COM
AS LETRAS QUE ESTÃO INDICADAS NOS BALÕES.

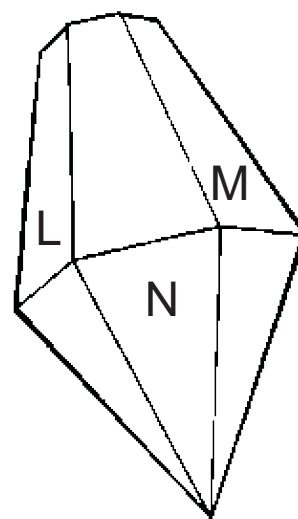
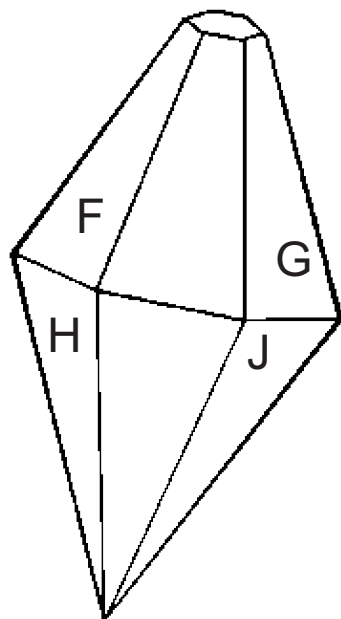
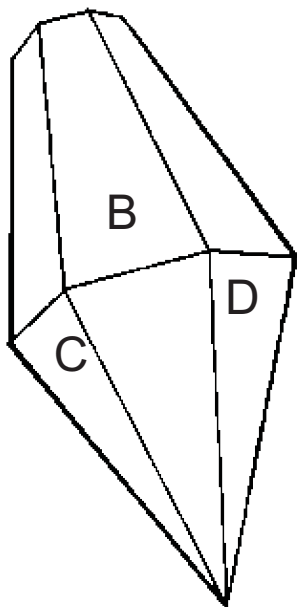

B _____

H _____

C _____

J _____

D _____

L _____

F _____

M _____

G _____

N _____

ESCREVA UMA PALAVRA QUE INICIE
COM AS LETRAS QUE ESTÃO INDICADAS NO JABUTI.

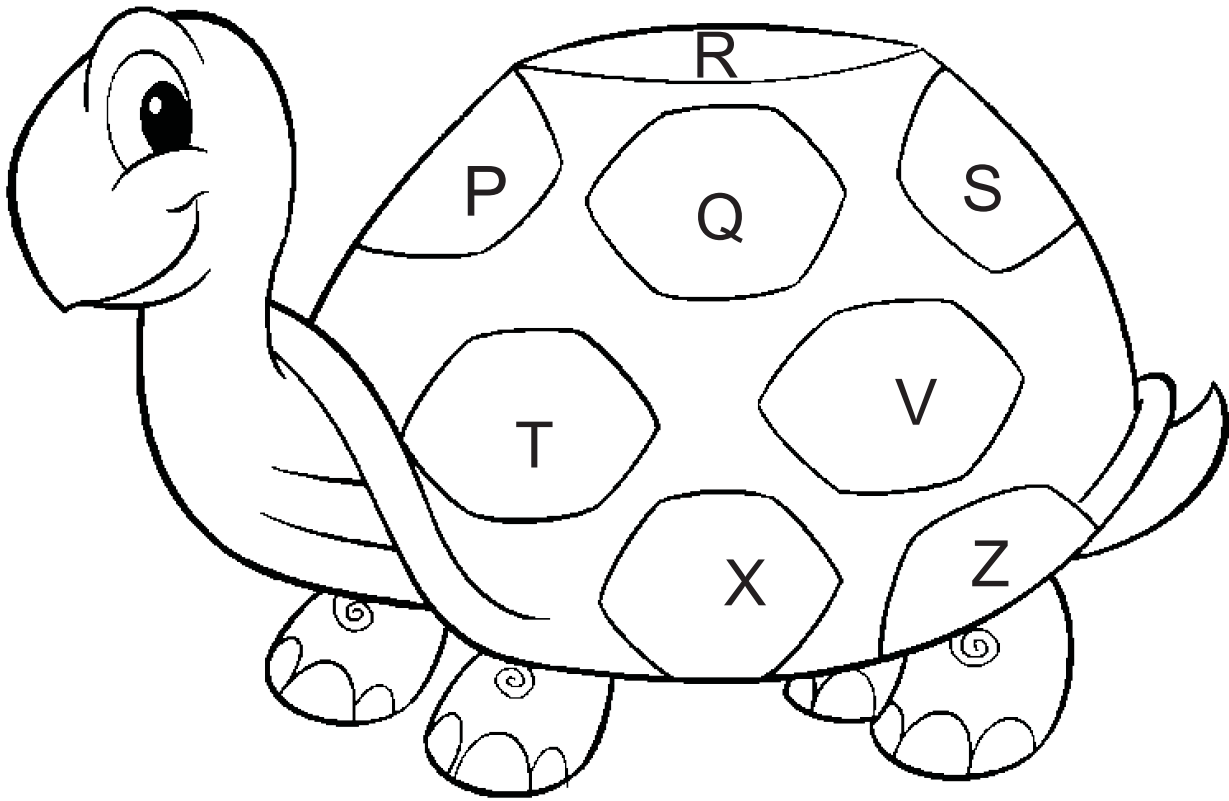

P _____

Q _____

R _____

S _____

T _____

V _____

X _____

Z _____

a q u b A C S Z m X N O P C G V

LIGUE E PINTE AS FRUTAS QUE COMEÇAM COM A MESMA LETRA.

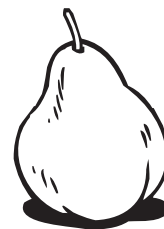
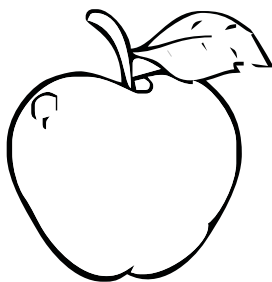
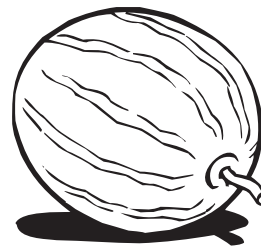
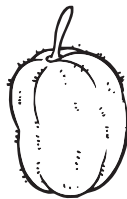
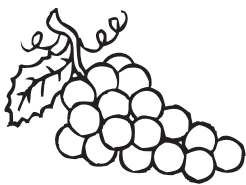
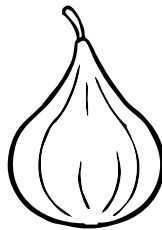
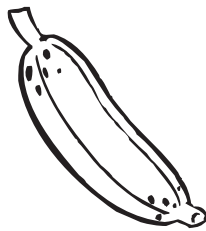
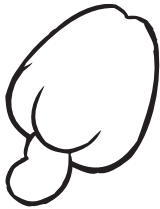
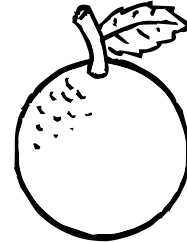
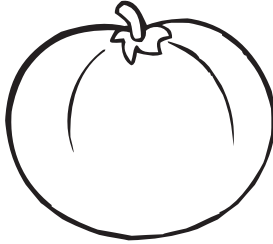
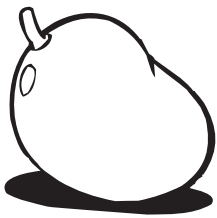

C b v H A B q A C u z m O X

PREENCHA O QUADRO DE ACORDO COM O MODELO.

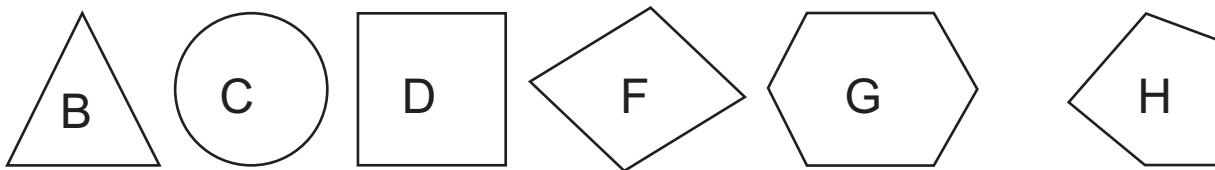

COPIE AS LETRAS.

B	C	D	F	G	H
B	C	D	F	G	H

RECORTE E COLE LETRAS DE REVISTA OU JORNAL.

1-PALAVRAS QUE COMEÇAM COM A LETRA DE SEU NOME.



2-PALAVRAS QUE NÃO COMEÇAM COM A LETRA DO SEU NOME.



COLE FIGURAS CUJO NOME COMECE
COM A PRIMEIRA LETRA DE SEU NOME.



a q u b A C S z m X N O p c G V

DESENHE NO ESPAÇO ABAIXO SEUS BRINQUEDOS
PREFERIDOS. NO QUADRINHO AO LADO, ESCREVA
A LETRA INICIAL DO BRINQUEDO.

p
c
c
v
o
g
s
a
s
u
D
q
N
G
c
h

g
a
s
u
q
h
z
s
p
r
D
A
m
O
V
p
N

C b v H a B q A C u z m O X

RECORTE DE REVISTA /JORNAL, QUATRO LETRAS E COLE NO ESPAÇO MENOR. FAÇA ALGUM DESENHO QUE REPRESENTA A LETRA COLADA.

a q u b A C S Z m X N O P C G V

LIGUE E PINTE AS FIGURAS QUE COMEÇAM COM A MESMA LETRA.

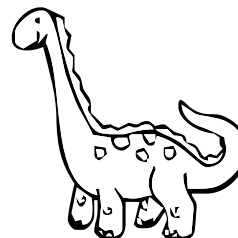
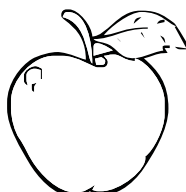
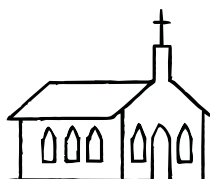
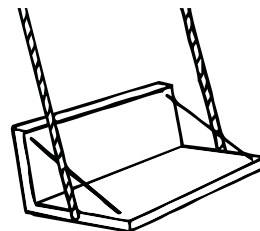
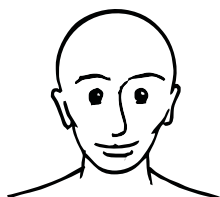
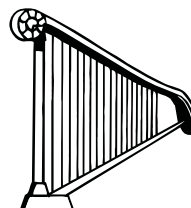
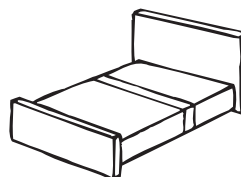
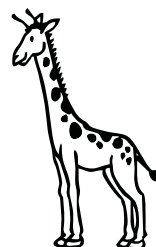
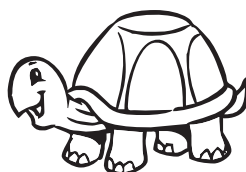
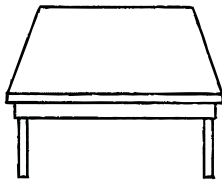
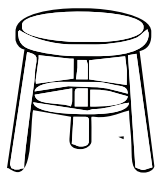

C b v H a B q A C u z m O X

a q u b A C S Z m X N O P C G V

LIGUE E PINTE AS FIGURAS QUE COMEÇAM COM A MESMA LETRA.

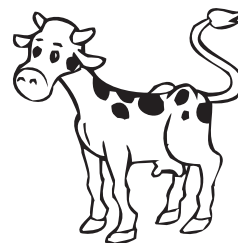
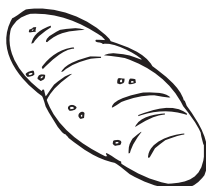
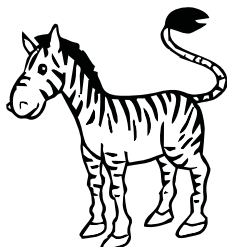
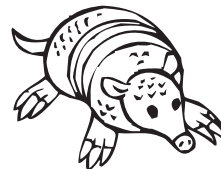
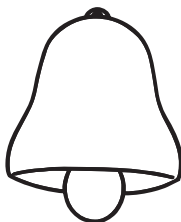
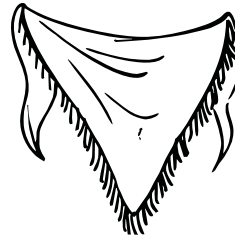
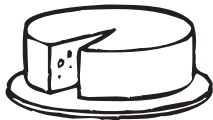
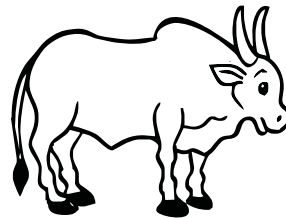
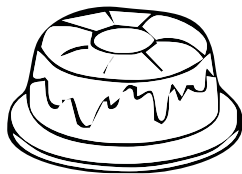
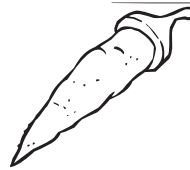
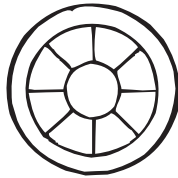
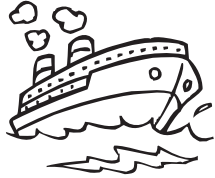

C b v H a B q A C u z m O X

PINTE AS LETRAS QUE FORMAM O NOME DA FIGURA.

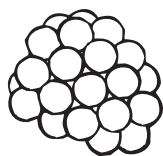

B A C M O D R A



F C G A H Q U I

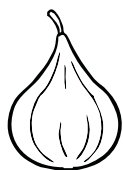

F J I K L G M O

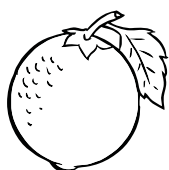

N L P I M Ã Q O



S P V Ê T R A V

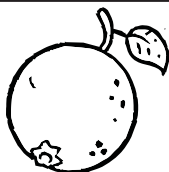

G X O I Z A B A



J G A P M C Q A

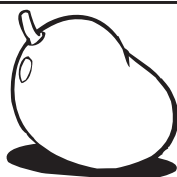

M B A N Z G A X

SIGA AS SETAS E FORME PALAVRAS.

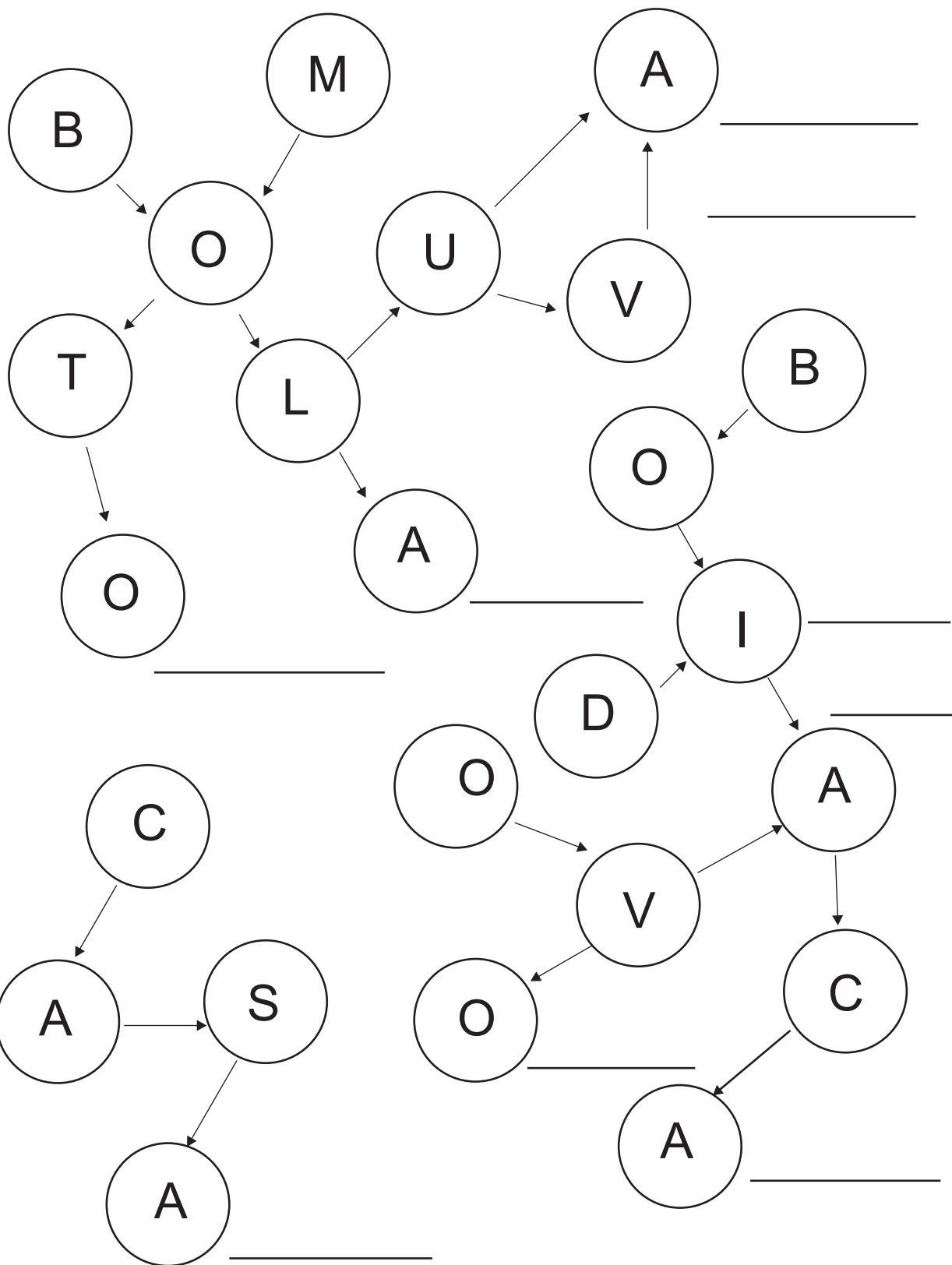

ESCREVA A LETRA FUJONA DAS PALAVRAS ABAIXO.

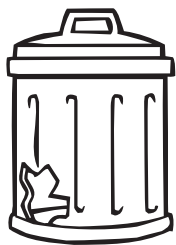

LI__O

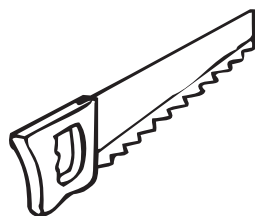

SERRO__E

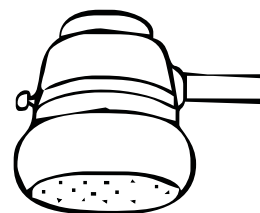

__HUVEIRO

3

TRÊ__

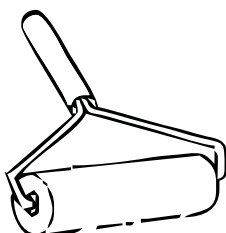

RO__O

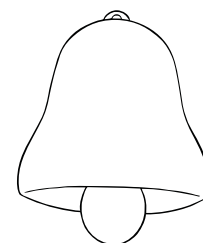

__INO



__OCA



__OLHA

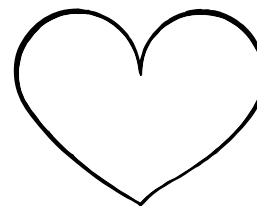

__ORAÇÃO

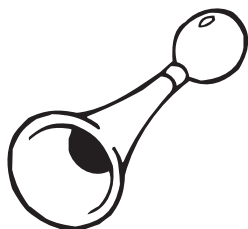

BU__INA

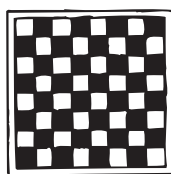

__ADREZ



FO__ÃO

a q u b A C S z m X N O p c g v

ESTAS SÃO DUAS PÁGINAS DE FIGURINHAS DE UM ÁLBUM. PINTE-AS, RECORTE-AS E COLE-AS NO LUGAR CORRESPONDENTE.

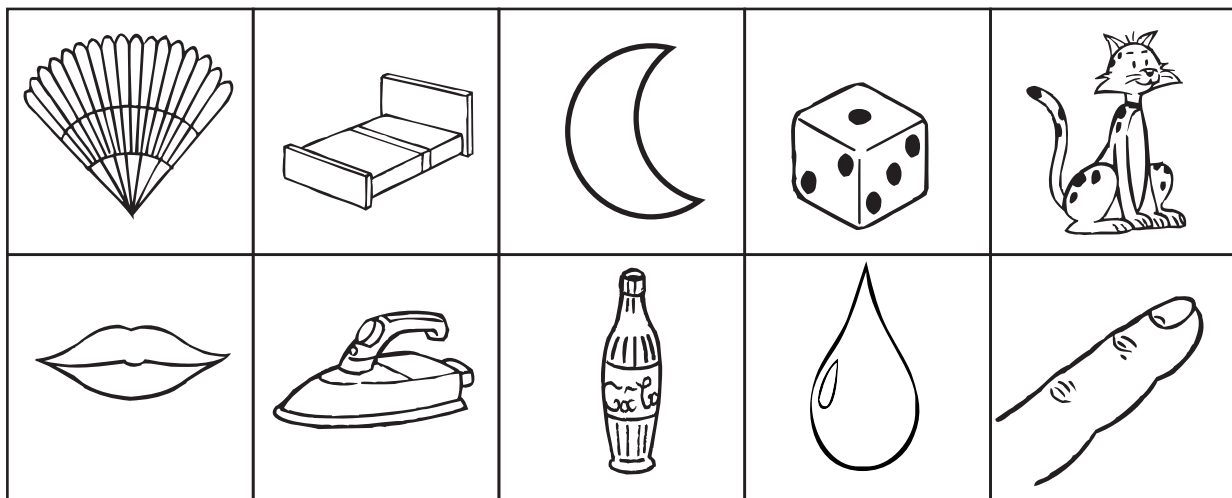
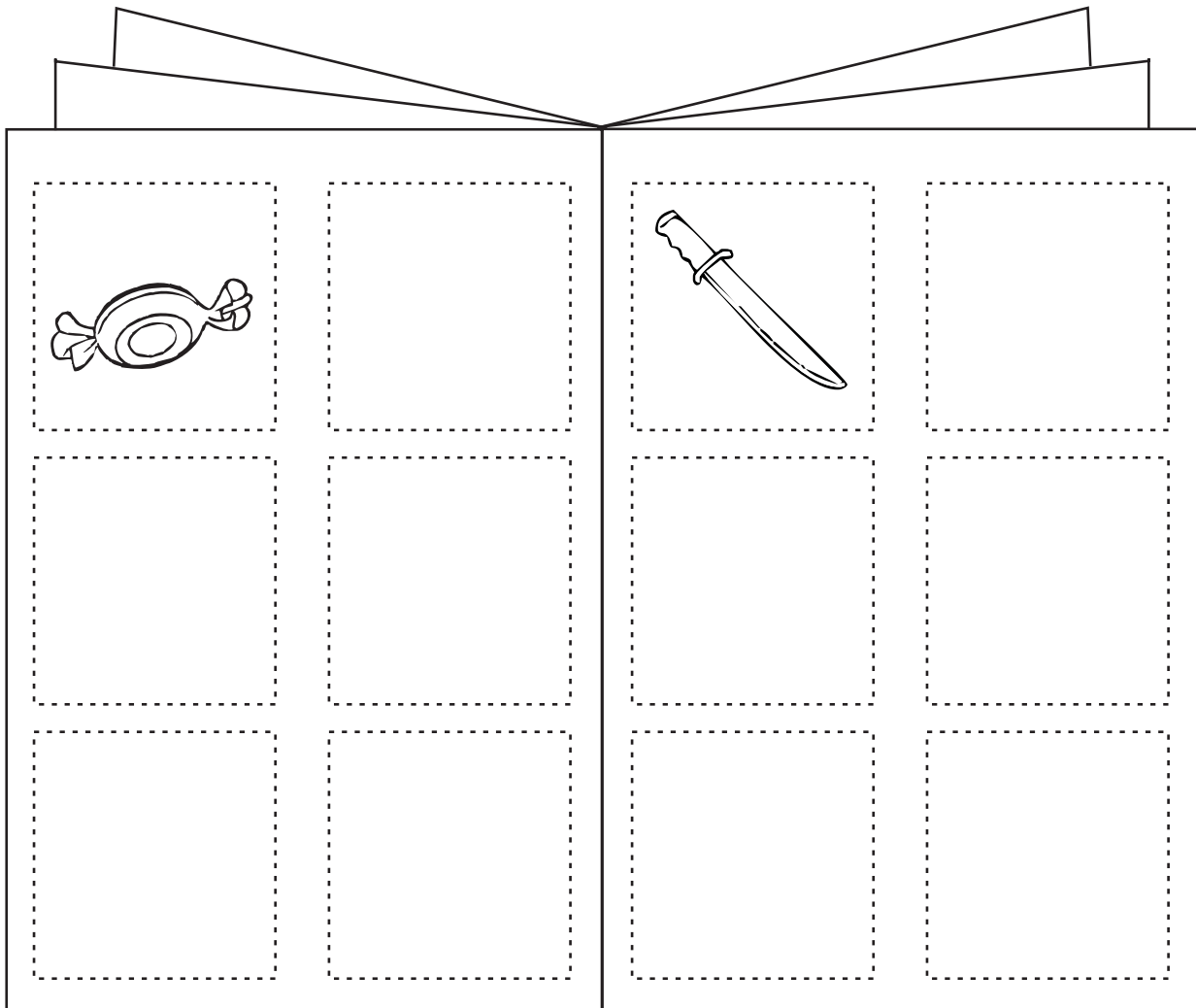

C b v H a B q A C u z m O X

a q u b A C S Z m X N O P C G V

JOGO DA ROLETA

AO PARAR A ROLETA, A CRIANÇA DEVERÁ DIZER QUAL É A LETRA INICIAL DO DESENHO.

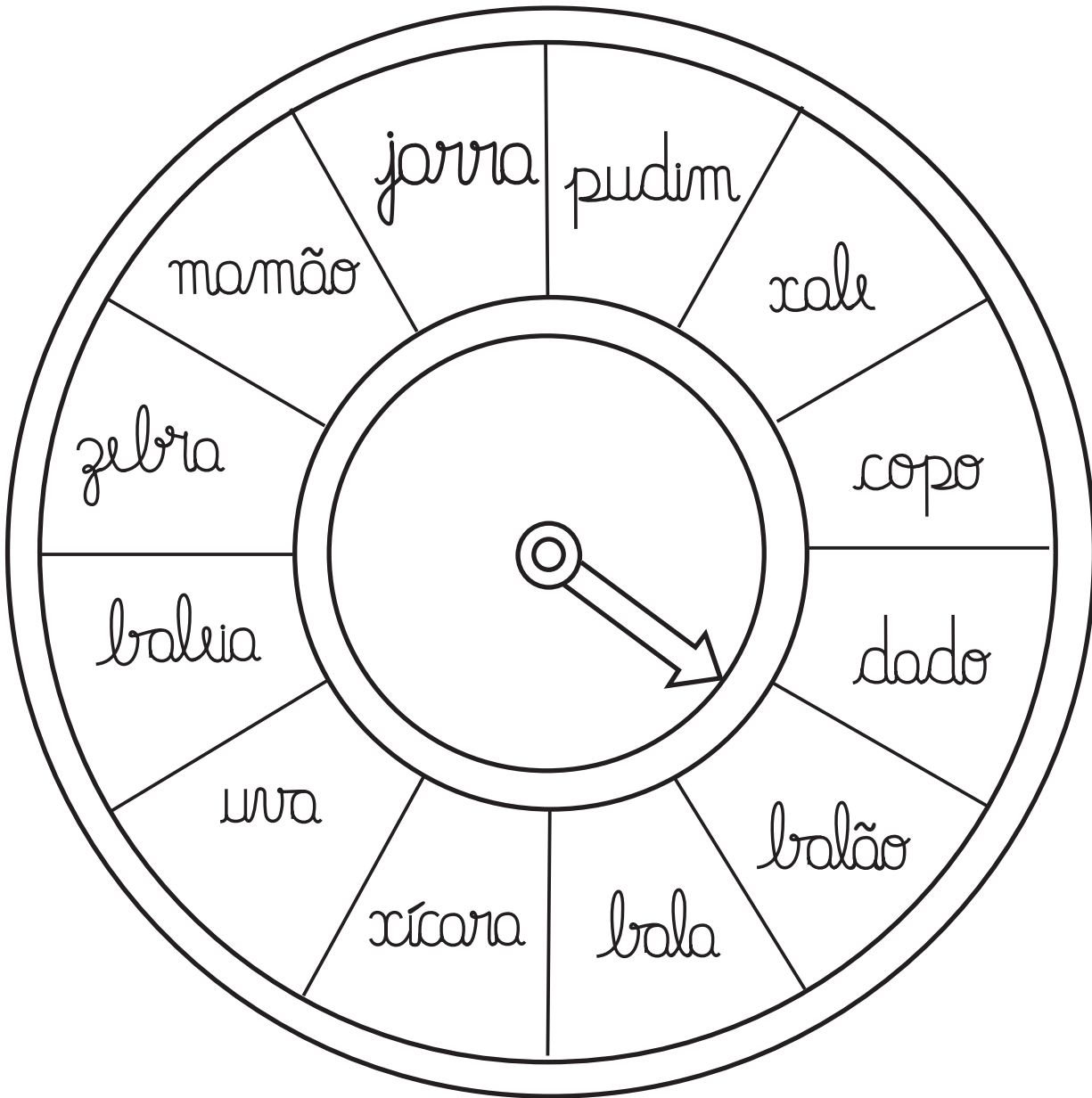

SÃO 2 CÍRCULOS (UM GRANDE COM OS DESENHOS E OUTRO NO CENTRO COM A SETA). PERFURAR E COLOCAR UMA SETA BAILARINA (ABRÍ-LA NO VERSO)

C b v H a B q A C U Z m O X

QUAL É A PALAVRA?
 PINTE AS LETRAS QUE CORRESPONDEM
 AOS DESENHOS E ESCREVA A PALAVRA.

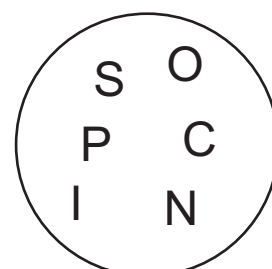
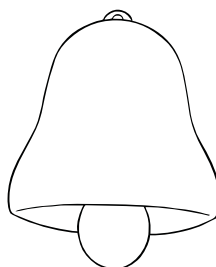
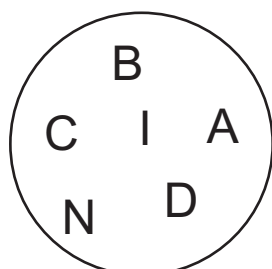
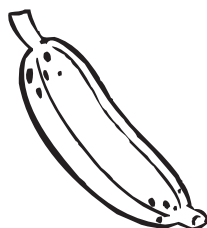
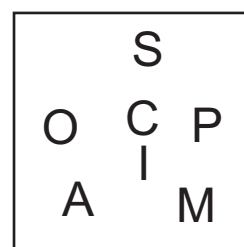
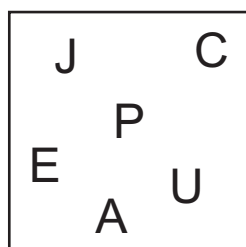
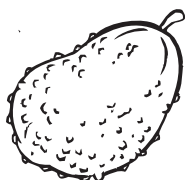
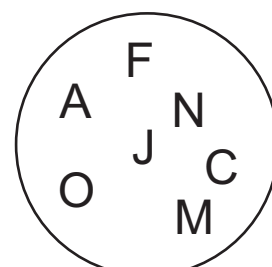
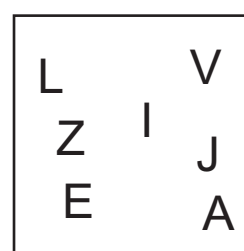
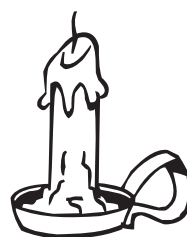
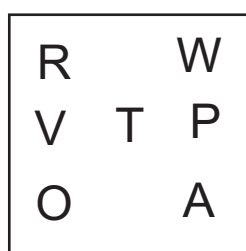
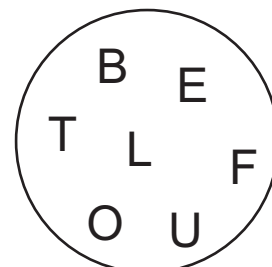
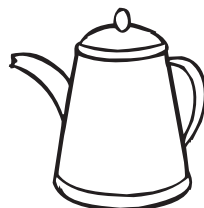
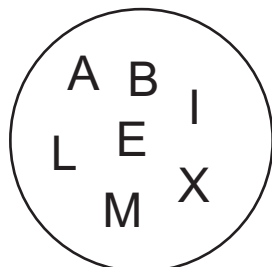

COMPLETE COM O QUE SE PEDE.

	LETRA INICIAL	LETRA FINAL	TOTAL DE LETRAS	NÚMERO DE VOGAIS	NÚMERO DE CONSOANTES
BALA					
BALEIA					
OBA					
IOIÔ					
ABACAXI					
POMADA					
URUBU					
ELEFANTE					
KIWI					
XADREZ					

OBSERVE O QUADRO DE PALAVRAS E
COPIE-AS NAS FICHAS, EM ORDEM ALFABÉTICA.

DAMA	BONÉ	ILHA
HIENA	NOME	PÊRA
MÃO	QUADRO	FOGO
RUA	UNHA	YOPA
ABÓBORA	ÉGUA	KIWI
JIPE	LÁPIS	OLHO
TESOURA	XALE	VÉU
GIRAFÁ	SALA	CABIDE
WILSON	ZEBRA	

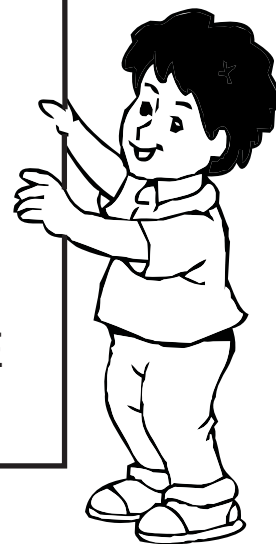

a q u b A C S Z m X N O P C G V

p
c
v
o
g
s
a
s
u
D
q
N
G
C
h

g
a
S
U
q
h
Z
S
P
r
D
A
m
O
V
P
N

ESTE É O SEU ALFABETO, COMPLETE-O.

A de _____

B de _____

C de _____

D de _____

E de _____

F de _____

G de _____

H de _____

I de _____

J de _____

K de _____

L de _____

M de _____



continua...

C b v H a B q A C u z m O X

a q u b A C S Z m X N O P C G V

p
c
v
o
s
a
s
u
D
q
N
G
C
h

g
a
S
U
q
h
Z
S
P
r
D
A
m
O
V
P
N

continuação

N de _____

O de _____

P de _____

Q de _____

R de _____

S de _____

T de _____

U de _____

V de _____

W de _____

X de _____

Y de _____

Z de _____

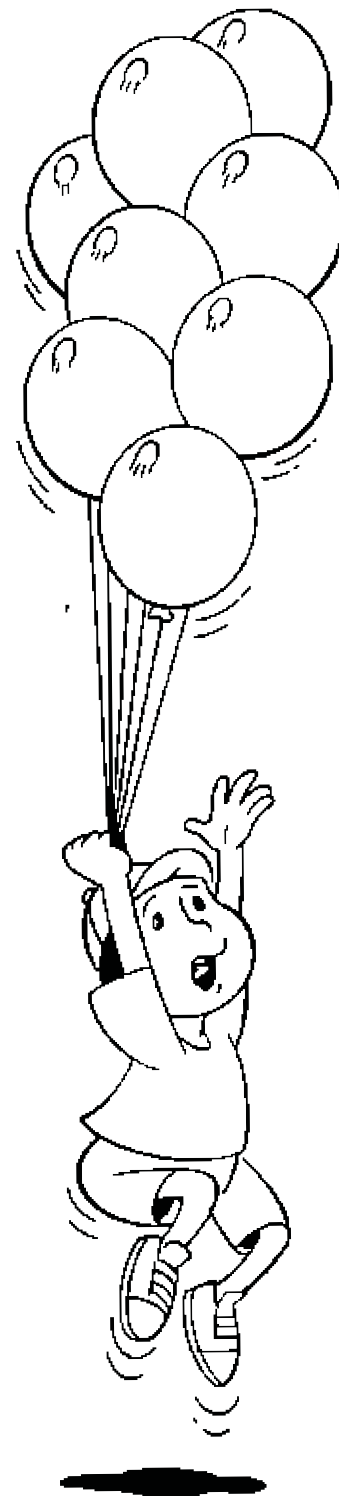

C b v H a B q A C u z m O X

a q u b A C S Z m X N O p c g v

p
c
v
o
g
s
w
s
u
d
q
n
g
h
c
h

g
a
s
u
q
h
z
s
p
r
d
a
m
o
v
p
n

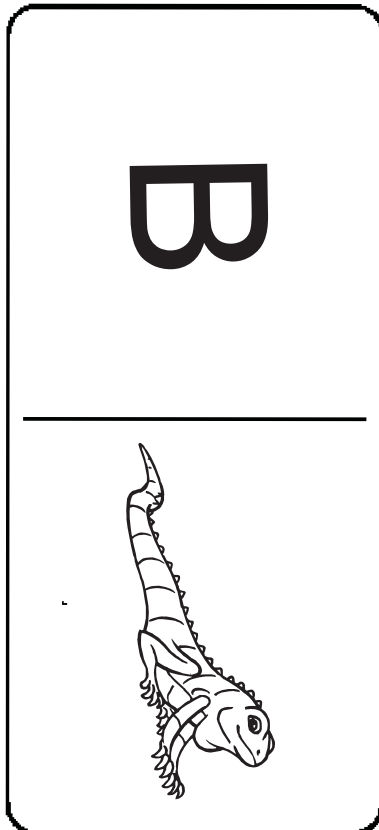
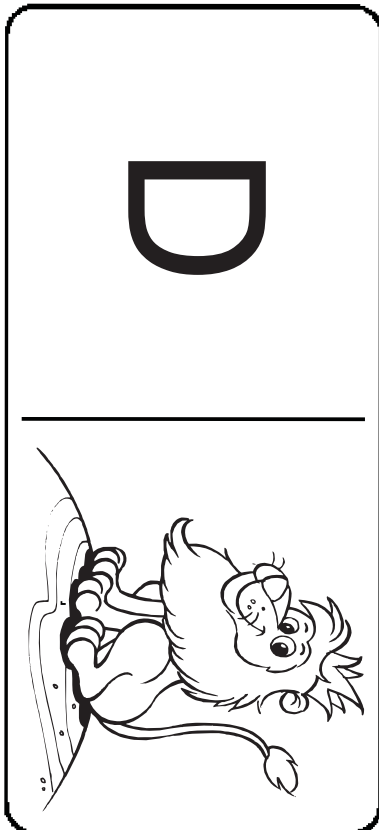
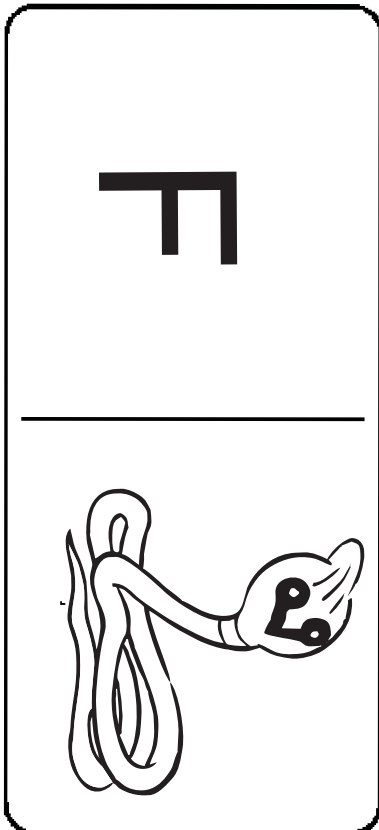
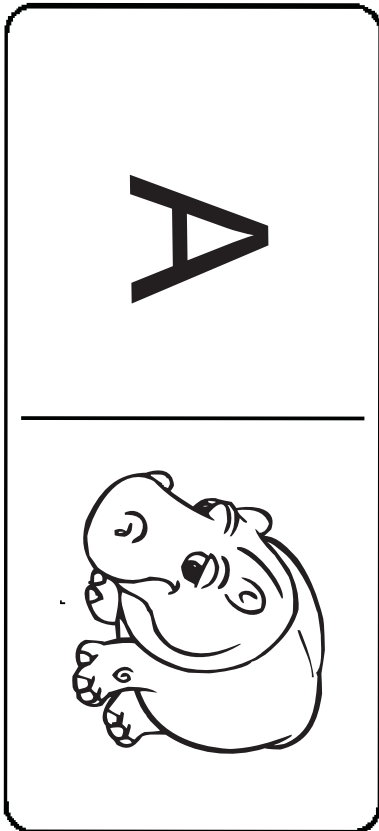
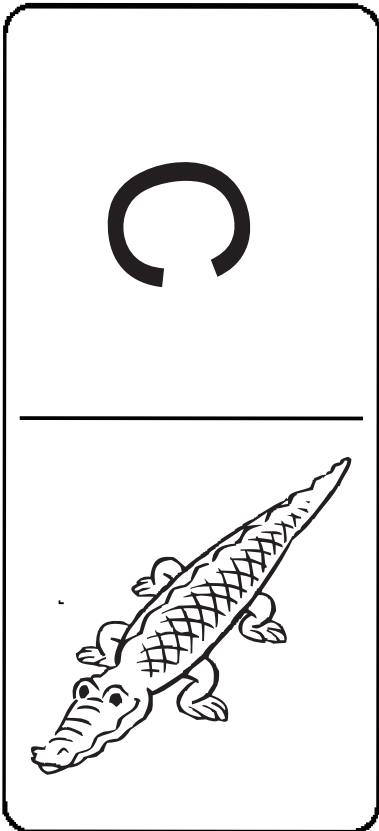
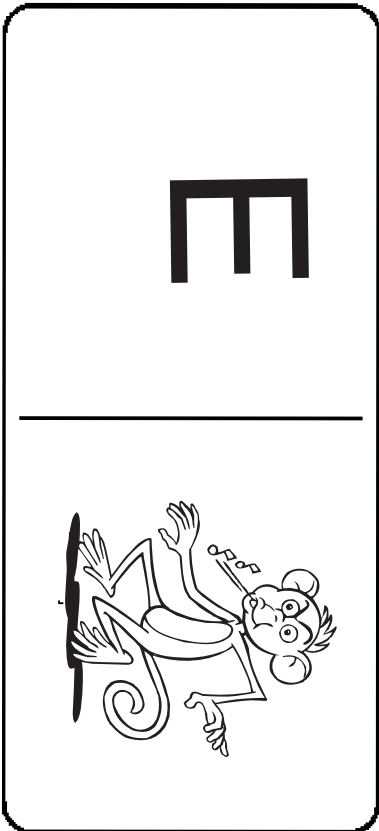

DOMINÓ

continua...

c b v h a B q A C u z m o x

continuação

K

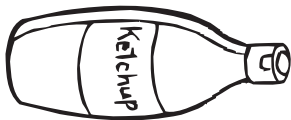

I



G

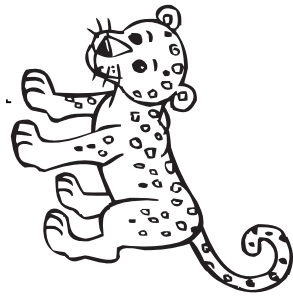

L

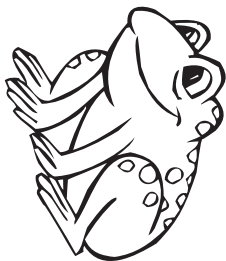

J



H



DOMINÓ

continua...

continuação

Q

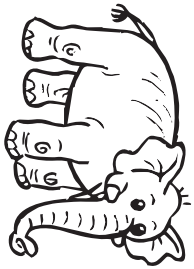

O

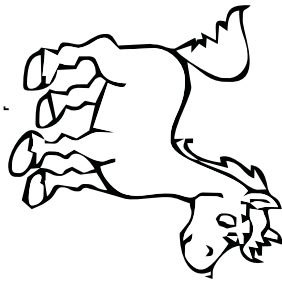

M

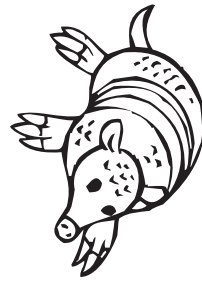

R



P

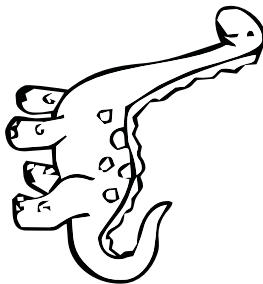

Z



DOMINÓ

continua...

continuação

U

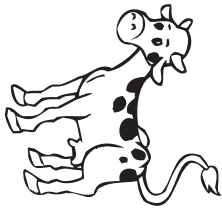

T



S

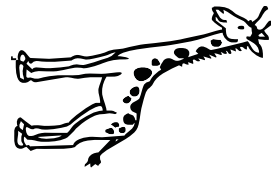

X

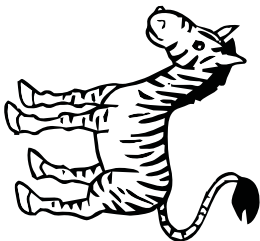

W



V



DOMINÓ

continua...

continuação

Y

Z

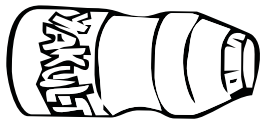

CARTELAS PARA FORMAR PALAVRAS









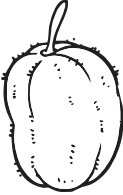
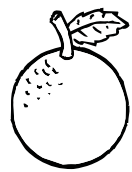
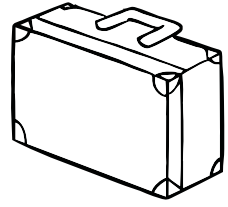
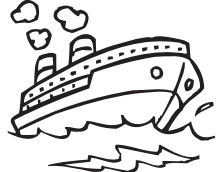

A	a	B	b
C	c	B	b

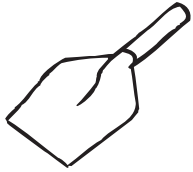
C	c	D	d	E	e	F	f
C	c	D	d	E	e	F	f

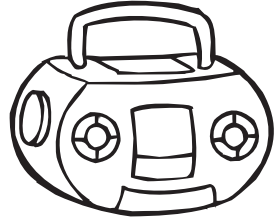
G	g	H	h	I	i	J	j
G	g	H	h	I	i	J	j

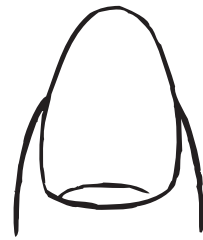
continua...

continuação

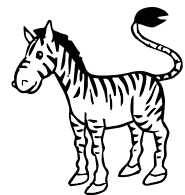
K  k	L  l	M  m	N  n
O  o	P  p	Q  q	R  r
S  s	T  t	U  u	V  v
W  w	X  x	Y  y	Z  z

CARTELA ALFABETO

A	B	C	D	E	F	G
A	B	C	D	E	F	G

H	I	J	K	L	M	N
H	I	J	K	L	M	N

O	P	Q	R	S	T	U
O	P	Q	R	S	T	U

V	W	X	Y	Z
V	W	X	Y	Z

A	À	B	Ɓ	C	Ç
D	Ð	E	Ǝ	F	ƒ
G	Ɠ	H	ℋ	I	Ɔ
J	ƚ	L	ℒ	M	ℓ
N	ƚ	O	Ɔ	P	Ɔ
Q	Ɔ	R	℞	S	Ɔ
T	ƚ	U	Ɔ	V	Ɔ
X	Ɔ	Z	ƚ	KK Yƚ	W Ɔ

A	A	A	B	B	B
C	C	C	D	D	D
E	E	E	F	F	F
G	G	G	H	H	H
I	I	I	J	J	J
K	K	K	L	L	L
M	M	M	N	N	N
O	O	O	P	P	P

Q	Q	Q	R	R	R
S	S	S	T	T	T
U	U	U	V	V	V
W	W	W	X	X	X
Y	Y	Y	Z	Z	Z
Ã	Ã	Ã	Õ	Õ	Õ
Ç	Ç	Ç	Á	Á	Á
É	É	É	É	Í	Í
Í	Í	Ô	Ô	Ô	Ô